

tbloc

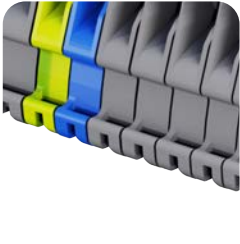

2026
fiyat listesi
ŞUBAT

TBLOC 2020 yılının Ocak ayında İzmir'de kurulmuş bir endüstri firmasıdır. Yeni bir firma olmasına rağmen kökleri uzun yıllara dayanan tecrübe ve birikimler nedeniyle çok derindedir. TBLOC, Türkiye'nin yeni bağlantı elemanları markası olarak Ar-Ge, Üretim ve Satış faaliyetlerini tek çatı altında yürütmekte ve bir Türk markası olarak uluslararası standartlarda ürettiği ürünleri tüm dünyaya ihraç etmektedir.

TBLOC markası, klemensin İngilizce karşılığı olan Terminal Block kelimelerinin bir kısaltması olarak görünse de "t" harfi teknolojinin kısaltması olarak markamızın başında, şirketimizin uzun vadeli planlarının göstergesi olarak yerini almıştır.

Tbloc Kurumsal

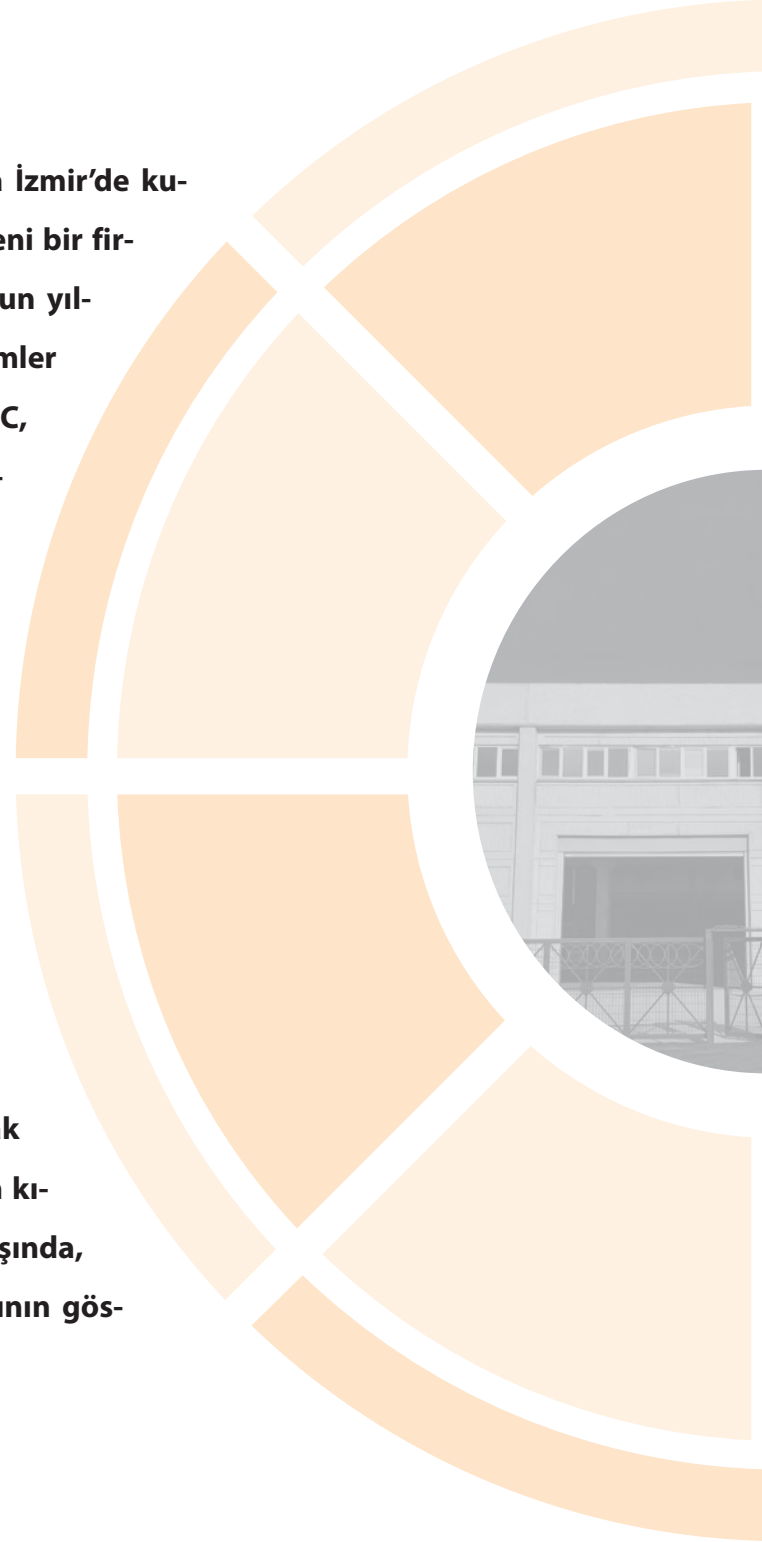



TBLOC is an industrial company established in January 2020 in İzmir/Turkey. Even though TBLOC is a new company, it has deep roots backed up with long years experience and knowledge. TBLOC, as a new brand in connectivity industry, is gathering all R&D, production and sales & marketing functions under one roof with the aim of becoming a global brand and supplying to international markets.

Despite TBLOC brand is being perceived as an abbreviation of Terminal Block definition, first letter "t" stands for technology and indicates our company's long term vision.

Tbloc Corporate

İçindekiler / Contents

● Klemensler ve Aksesuarları Terminal Blocks and Accessories	6 - 26
● Klemens Etiketleri Marking Tags	27 - 31
● Klemens Aksesuar Seçim Tablosu Terminal Blocks Accessories Selection Table	32 - 39
● Montaj Rayları ve Aksesuarları Mounting Rails and Accessories	40 - 41
● Dağıtım Blokları Distribution Blocks	42 - 43
● Müşterek W Otomat Baraları PIN MCB Busbars	44
● Kablo Kanalları Wiring Ducts	45 - 46
● Lazer Marklama ve Termal Markalama Sistemleri Lazer Marking and Thermal Marking Systems	47 - 60
● Kablo Bağları, Kroşeler ve Paslanmaz Çelik Kablo Bağları - 304 Kalite Cable Ties, Tie Mounts and Stainless Steel Cable Ties	63 - 65
● Sıkmalı Kablo Pabuçları Compression Cable Lugs	66 - 68
● İzoleli ve İzolesiz Kablo Yüksükleri - İzoleli Kablo Pabuçları Insulated and Non-Insulated End Sleeves - Insulated Cable Terminals	69- 74
● Ledli Sinyal Lambaları ve Kumanda Butonları Led Indicators and Push Buttons	75 - 76
● Endüstriyel ve PLC Röleler Industrial and PLC Relays	83 - 89

Genel Şartlar

- Fiyatlara K.D.V. dahil değildir.
- Fiyat listemiz 04 ŞUBAT 2026 tarihinden itibaren geçerli olan liste fiyatlarımızı içerir.
- Teslim anındaki fiyatlar geçerlidir.
- Önceden haber vermeksizin fiyat değiştirme hakkımız saklıdır.
- Sevkiyatlar standart ambalaja göre yapılır.
- Aksi bildirilmedikçe nakliye bedeli alıcıya aittir.
- Tbloc firmasının yazılı onayı olmadan iade kabul edilmeyecektir.
- Ürünlerimizde değişiklik yapma hakkımız saklıdır.
- İçeride görülen resim ve teknik değerler genel bilgi amaçlıdır.
- Listemizde bulamadığınız ürünler için lütfen satış birimimizle temasa geçiniz.

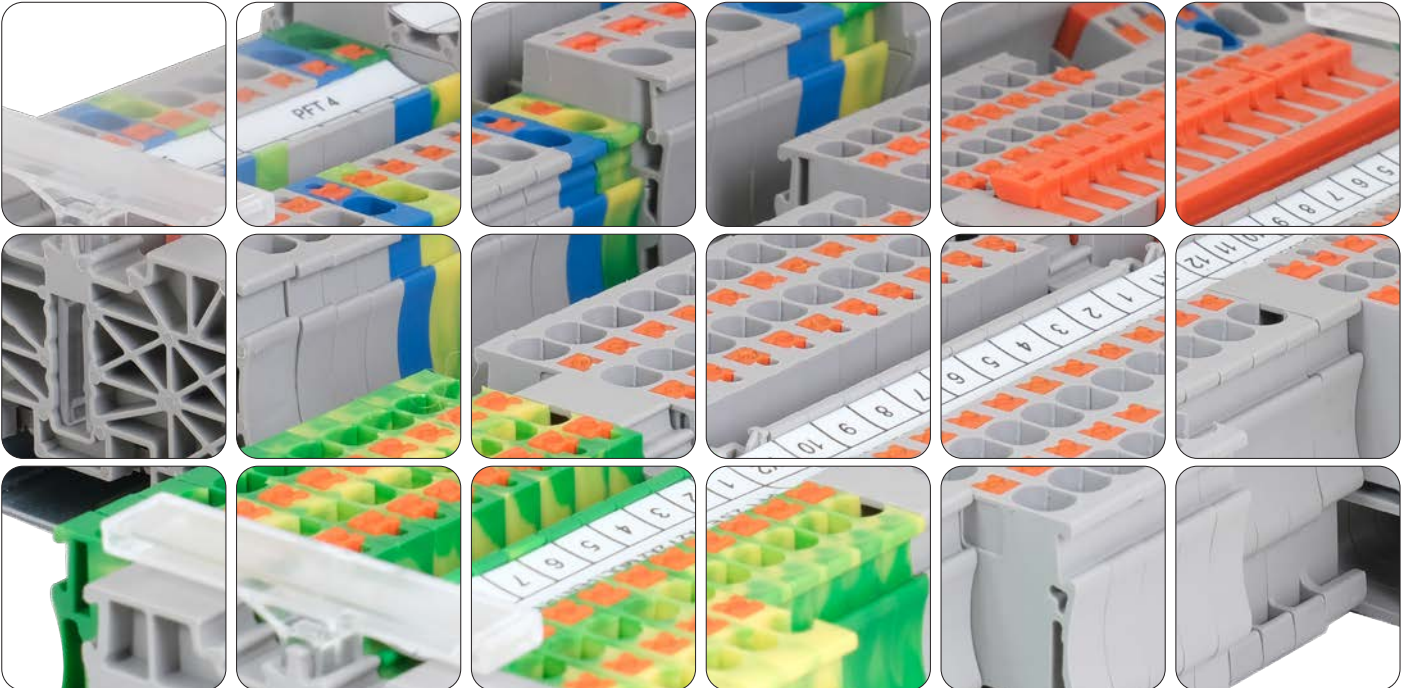

NTB

Geçiş Klemensleri
Çok Katlı Klemensler
Sigortalı ve Ayırmalı Klemensler
Topraklama Klemensleri

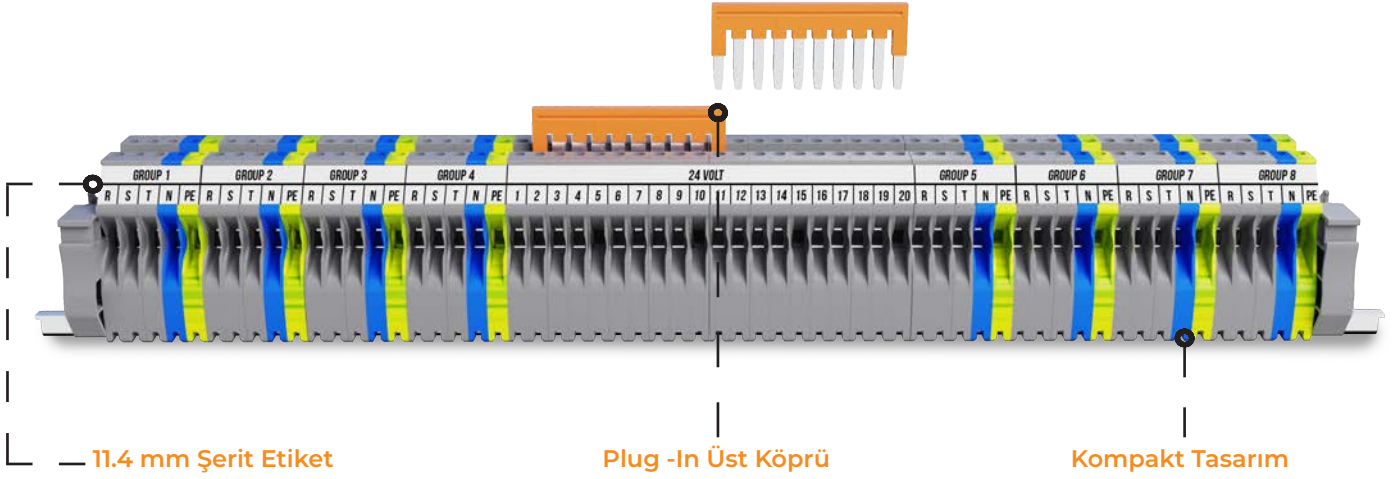

NTB 2,5

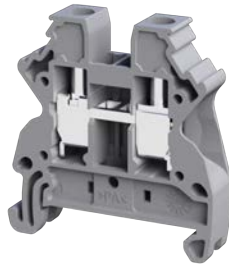

NTB 10



NTB Serisi Geçiş Klemensleri

NTB Series Feed Through Terminal Block

Ürün Kodu Product Code	Ürün Adı Product Name	Açıklama Explanation	Kesit Cross Sec. (mm ²)	Renk Color	Amb. Mik. Pack. Qty (Adet/Pcs.)	Koli Mik. Box.Qty. (Adet/Pcs.)	Birim Fiyatı Unit Price (TL/Adet)
8000099208	NTB 2,5	Geçiş Klemensi / Feed Through Terminal Block	2,5	Gri / Grey	100	1.000	39,98
8000099308	NTB 4	Geçiş Klemensi / Feed Through Terminal Block	4	Gri / Grey	85	850	46,48
8000099408	NTB 6	Geçiş Klemensi / Feed Through Terminal Block	6	Gri / Grey	65	650	68,03
8000099508	NTB 10	Geçiş Klemensi / Feed Through Terminal Block	10	Gri / Grey	50	500	87,46

Renk Kodları / Color Codes

800009900....	...0	...1	...2	...3	...4	...5	...6	...9
---------------	------	------	------	------	------	------	------	------

*Farklı renklerdeki klemens siparişlerinizi yukarıdaki renk skalasında verilen kodlara uygun olarak oluşturabilirsiniz.

**NTB serisi klemenslerin üst köprülerini seçmek için Sayfa 22'ye bakabilirsiniz.

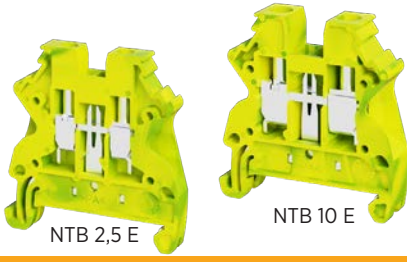

NTB 2,5 E

NTB 10 E



Vida Bağlantılı Topraklama Klemensleri

Screw Connection Earth Terminal Block

Ürün Kodu Product Code	Ürün Adı Product Name	Açıklama Explanation	Kesit Cross Sec. (mm ²)	Renk Color	Amb. Mik. Pack. Qty (Adet/Pcs.)	Koli Mik. Box.Qty. (Adet/Pcs.)	Birim Fiyatı Unit Price (TL/Adet)
8001099304	NTB 2,5 E	Topraklama Klemensi / Earth Terminal Blocks	2,5	Sarı-Yeşil / Yellow-Green	70	1400	168,94
8001099314	NTB 4 E	Topraklama Klemensi / Earth Terminal Blocks	4	Sarı-Yeşil / Yellow-Green	60	900	194,35
8001099324	NTB 6 E	Topraklama Klemensi / Earth Terminal Blocks	6	Sarı-Yeşil / Yellow-Green	45	720	252,66
8001099334	NTB 10 E	Topraklama Klemensi / Earth Terminal Blocks	10	Sarı-Yeşil / Yellow-Green	35	560	291,53

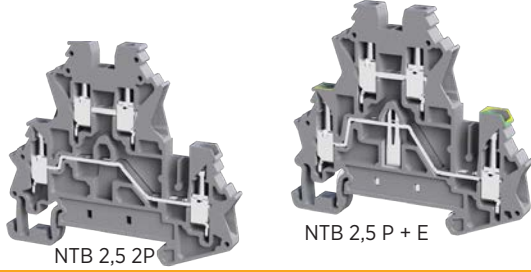

NTB 2,5 2P

NTB 2,5 P + E



NTB Serisi Çok Katlı Klemensler

NTB Series Multilevel Terminal Blocks

Ürün Kodu Product Code	Ürün Adı Product Name	Açıklama Explanation	Kesit Cross Sec. (mm ²)	Renk Color	Amb. Mik. Pack. Qty (Adet/Pcs.)	Koli Mik. Box.Qty. (Adet/Pcs.)	Birim Fiyatı Unit Price (TL/Adet)
8002099558	NTB 2,5 2P	2 katlı geçiş klemensi 2 levels feed through terminal blocks	2,5	Gri / Grey	30	600	120,84
8002099556	NTB 2,5 2P	2 katlı geçiş klemensi 2 levels feed through terminal blocks	2,5	Mavi / Blue	30	600	120,84
8002099568	NTB 2,5 P + E	1 katı geçiş, 1 katı topraklama klemensi 1 level feed through, 1 level earth terminal blocks	2,5	Gri / Grey	30	600	260,26
8002099658	NTB 4 2P	2 katlı geçiş klemensi 2 levels feed through terminal blocks	4	Gri / Grey	30	600	143,72
8002099668	NTB 4 P + E	1 katı geçiş, 1 katı topraklama klemensi 1 level feed through, 1 level earth terminal blocks	4	Gri / Grey	30	600	306,33

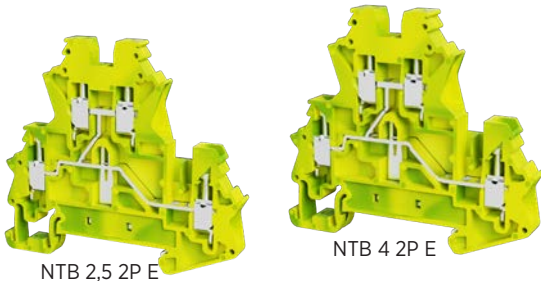

NTB 2,5 2P E

NTB 4 2P E



NTB Serisi Çok Katlı Topraklama Klemensleri

NTB Series Multilevel Earth Terminal Blocks

Ürün Kodu Product Code	Ürün Adı Product Name	Açıklama Explanation	Kesit Cross Sec. (mm ²)	Renk Color	Amb. Mik. Pack. Qty (Adet/Pcs.)	Koli Mik. Box.Qty. (Adet/Pcs.)	Birim Fiyatı Unit Price (TL/Adet)
8002099574	NTB 2,5 2P E	2 katlı topraklama klemensi 2 levels earth terminal blocks	2,5	Sarı-Yeşil / Yellow-Green	30	600	280,20
8002099674	NTB 4 2P E	2 katlı topraklama klemensi 2 levels earth terminal blocks	4	Sarı-Yeşil / Yellow-Green	30	600	326,05

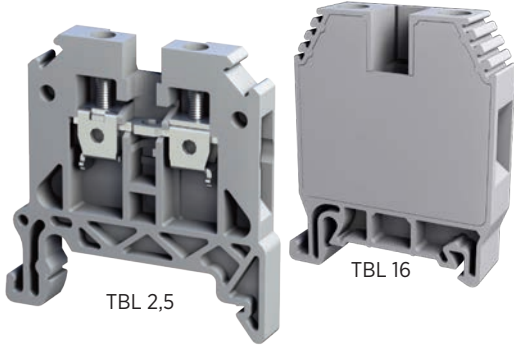

TBL Serisi Geçiş Klemensleri

TBL Series Feed Through Terminal Block

Ürün Kodu Product Code	Ürün Adı Product Name	Açıklama Explanation	Kesit Cross Sec. (mm ²)	Renk Color	Amb. Mik. Pack. Qty (Adet/Pcs.)	Koli Mik. Box.Qty. (Adet/Pcs.)	Birim Fiyatı Unit Price (TL/Adet)
8000099008	TBL 2,5	Geçiş Klemensi / Feed Through Terminal Block	2,5	Gri / Grey	100	1.000	38,04
8000099028	TBL 4	Geçiş Klemensi / Feed Through Terminal Block	4	Gri / Grey	100	1.000	45,05
8000099038	TBL 6	Geçiş Klemensi / Feed Through Terminal Block	6	Gri / Grey	80	1.200	62,19
8000099048	TBL 10	Geçiş Klemensi / Feed Through Terminal Block	10	Gri / Grey	60	900	81,08
8000099058	TBL 16	Geçiş Klemensi / Feed Through Terminal Block	16	Gri / Grey	50	500	133,22
8000099068	TBL 25	Geçiş Klemensi / Feed Through Terminal Block	25	Gri / Grey	50	500	214,74
8000099078	TBL 35	Geçiş Klemensi / Feed Through Terminal Block	35	Gri / Grey	20	320	274,40
8000099088	TBL 50	Geçiş Klemensi / Feed Through Terminal Block	50	Gri / Grey	20	200	786,70

Renk Kodları / Color Codes

800009900.... ...0 ...1 ...2 ...3 ...4 ...5 ...6 ...9

*Farklı renklerdeki klemens siparişlerinizi yukarıdaki renk skalasında verilen kodlara uygun olarak oluşturabilirsiniz.

**TBL serisi klemenslerin üst köprülerini seçmek için Sayfa 16'ya bakabilirsiniz açıklamasını ekleyelim.

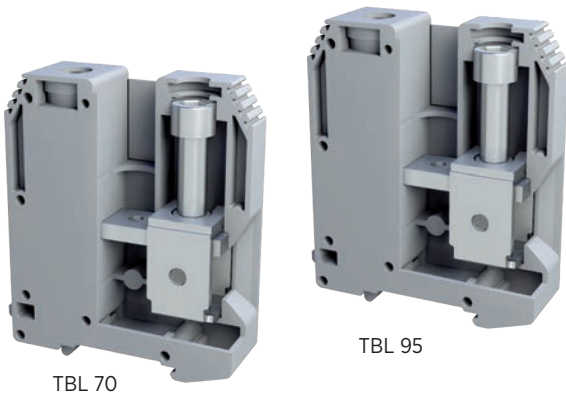

8000099098	TBL 70	Geçiş Klemensi / Feed Through Terminal Block	70	Gri / Grey	10	50	1.078,90
8000099096	TBL 70	Geçiş Klemensi / Feed Through Terminal Block	70	Mavi / Blue	10	50	1.078,90
8000099108	TBL 95	Geçiş Klemensi / Feed Through Terminal Block	95	Gri / Grey	5	50	1.350,78
8000099106	TBL 95	Geçiş Klemensi / Feed Through Terminal Block	95	Mavi / Blue	5	50	1.350,78
8000099118	TBL 150	Geçiş Klemensi / Feed Through Terminal Block	150	Gri / Grey	5	50	1.613,11
8000099116	TBL 150	Geçiş Klemensi / Feed Through Terminal Block	150	Mavi / Blue	5	50	1.613,11

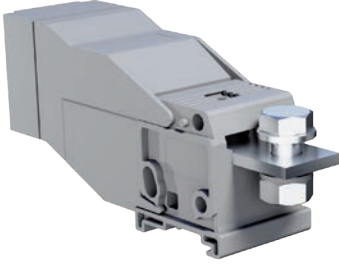

TBB 70



C-TBB 70-95-150



Yüksek Akım Klemensi

High Current Terminal Blocks

Ürün Kodu Product Code	Ürün Adı Product Name	Açıklama Explanation	Kesit Cross Sec. (mm ²)	Renk Color	Amb. Mik. Pack. Qty (Adet/Pcs.)	Koli Mik. Box.Qty. (Adet/Pcs.)	Birim Fiyatı Unit Price (TL/Adet)
8000099128	TBB 70	Yüksek Akım Klemensi / High Current Terminal Blocks	70	Gri / Grey	5	50	1.275,14
8000099138	TBB 95	Yüksek Akım Klemensi / High Current Terminal Blocks	95	Gri / Grey	5	50	1.361,59
8000099148	TBB 150	Yüksek Akım Klemensi / High Current Terminal Blocks	150	Gri / Grey	5	50	1.837,06
8000099158	TBB 240	Yüksek Akım Klemensi / High Current Terminal Blocks	240	Gri / Grey	4	40	2.623,73

Koruma Kapakları / Isolation Covers

8012396608	C-TBB 70-95-150	Koruma Kapağı / Isolation Cover	70-150	Gri / Grey	10	150	242,94
8012396618	C-TBB 240	Koruma Kapağı / Isolation Cover	240	Gri / Grey	8	150	295,58

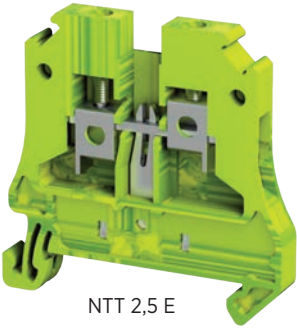

NTT 2,5 E







TBL 16 E



Vida Bağlantılı Topraklama Klemensleri

Screw Connection Earth Terminal Block

Ürün Kodu Product Code	Ürün Adı Product Name	Açıklama Explanation	Kesit Cross Sec. (mm ²)	Renk Color	Amb. Mik. Pack. Qty (Adet/Pcs.)	Koli Mik. Box.Qty. (Adet/Pcs.)	Birim Fiyatı Unit Price (TL/Adet)
8001099214	NTT 2,5 E 	Topraklama Klemensi / Earth Terminal Blocks	2,5	Sarı-Yeşil / Yellow-Green	50	500	149,66
8001099224	NTT 4 E 	Topraklama Klemensi / Earth Terminal Blocks	4	Sarı-Yeşil / Yellow-Green	50	500	171,03
8001099234	NTT 6 E 	Topraklama Klemensi / Earth Terminal Blocks	6	Sarı-Yeşil / Yellow-Green	25	500	227,39
8001099244	NTT 10 E 	Topraklama Klemensi / Earth Terminal Blocks	10	Sarı-Yeşil / Yellow-Green	20	400	266,26
8001099194	TBL 16 E	Topraklama Klemensi / Earth Terminal Blocks	16	Sarı-Yeşil / Yellow-Green	20	340	363,43
8001099204	TBL 35 E	Topraklama Klemensi / Earth Terminal Blocks	35	Sarı-Yeşil / Yellow-Green	20	200	695,92

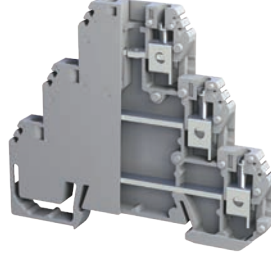
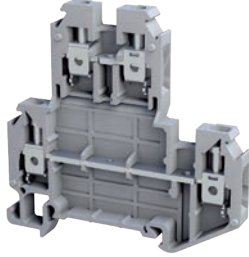
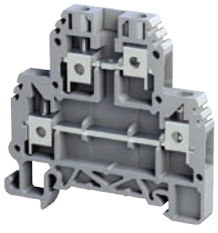

TBL 2,5-4 2P

TBL 4 2P

TBL 4 3P

TBL 2,5 2P+E



Vida Bağlantılı Çok Katlı Klemensler

Screw Type Multilevel Terminal Blocks

Ürün Kodu Product Code	Ürün Adı Product Name	Açıklama Explanation	Kesit Cross Sec. (mm ²)	Renk Color	Amb. Mik. Pack. Qty (Adet/Pcs.)	Koli Mik. Box.Qty. (Adet/Pcs.)	Birim Fiyatı Unit Price (TL/Adet)
8002099438	TBL 2,5-4 2P	2 katlı geçiş klemensi 2 levels feed through terminal blocks	2,5 - 4	Gri / Grey	50	600	114,67
8002099258	TBL 4 2P	2 katlı geçiş klemensi 2 levels feed through terminal blocks	4	Gri / Grey	50	800	135,71
8002099488	TBL 10 2P	2 katlı geçiş klemensi 2 levels feed through terminal blocks	10	Gri / Grey	25	300	330,40
8002099478	TBL 4 3P	3 katlı geçiş / 3 levels feed through	4	Gri / Grey	25	500	272,09
8002099158	TBL 2,5 - 2P+E	Çok katlı + topraklama klemensi Multi levels + earth terminal blocks	2,5	Gri / Grey	35	-	312,00

Renk Kodları / Color Codes

800009900...

...0

...1

...2

...3

...4

...5

...6

...9

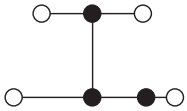

8002099428
TBL 4 2PK

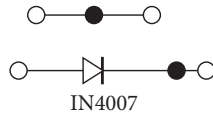

8002099268
TBL 4 2P X1

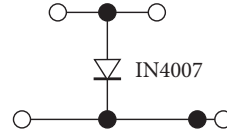

8002099278
TBL 4 2P X2

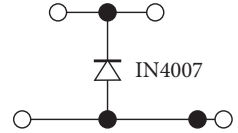

8002099288
TBL 4 2P X3

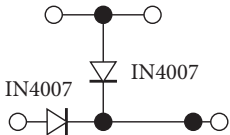

8002099298
TBL 4 2P X4

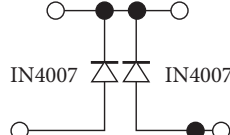

8002099305 **TBL 4 2P X5**
8002099318
TBL 4 2P X5 Gri

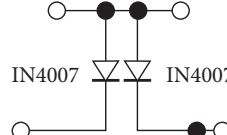

8002099328
TBL 4 2P X6

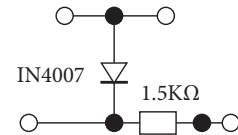

8002099348
TBL 4 2P X8

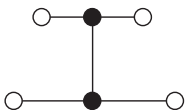

8002099448
TBL 2,5-4 2PK

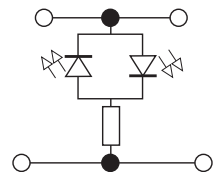

8002099458
TBL 2,5-4 2PL (24-48VAC/DC) Gri
8002099468
TBL 2,5-4 2PL (110-220VAC/DC) Gri

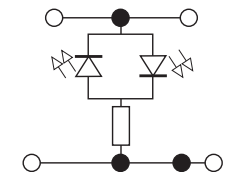

8002099368
TBL 4 2PL (24-48VAC/DC) Gri
8002099378
TBL 4 2PL (110-220VAC/DC) Gri

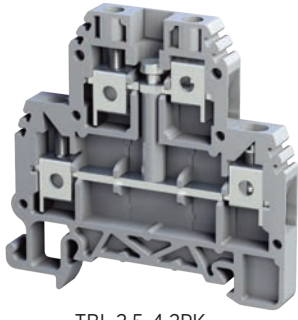

TBL 2,5-4 2PK





TBL 4 2P X1



Vida Bağlantılı Çok Katlı Klemensler

Screw Type Multilevel Terminal Blocks

Ürün Kodu Product Code	Ürün Adı Product Name	Açıklama Explanation	Kesit Cross Sec. (mm ²)	Renk Color	Amb. Mik. Pack. Qty (Adet/Pcs.)	Koli Mik. Box.Qty. (Adet/Pcs.)	Birim Fiyatı Unit Price (TL/Adet)
8002099448	TBL 2,5-4 2PK	2 katlı içeriden köprülü 2 levels internally bridged	2,5 - 4	Gri / Grey	50	600	252,66
8002099458	TBL 2,5-4 2PL(24-48VAC/DC) 	2 katlı ledli ve diyotlu 2 levels with led and diode	2,5 - 4	Gri / Grey	50	600	378,98
8002099468	TBL 2,5-4 2PL(110-220VAC/DC) 	2 katlı ledli ve diyotlu 2 levels with led and diode	2,5 - 4	Gri / Grey	50	600	378,98
8002099268	TBL 4 2P X1	2 katlı diyotlu 2 levels with diode	4	Gri / Grey	50	800	291,53
8002099278	TBL 4 2P X2	2 katlı diyotlu 2 levels with diode	4	Gri / Grey	50	800	291,53
8002099288	TBL 4 2P X3	2 katlı diyotlu 2 levels with diode	4	Gri / Grey	50	800	291,53
8002099298	TBL 4 2P X4	2 katlı diyotlu 2 levels with diode	4	Gri / Grey	50	800	291,53
8002099318	TBL 4 2P X5	2 katlı diyotlu 2 levels with diode	4	Gri / Grey	50	800	291,53
8002099305	TBL 4 2P X5 	2 katlı diyotlu 2 levels with diode	4	Yeşil / Green	50	800	291,53
8002099328	TBL 4 2P X6	2 katlı diyotlu 2 levels with diode	4	Gri / Grey	50	800	291,53
8002099338	TBL 4 2P X7	2 katlı diyotlu 2 levels with diode	4	Gri / Grey	50	800	291,53
8002099348	TBL 4 2P X8	2 katlı diyotlu 2 levels with diode	4	Gri / Grey	50	800	291,53
8002099368	TBL 4 2PL(24-48VAC/DC)	2 katlı ledli ve diyotlu 2 levels with led and diode	4	Gri / Grey	50	800	456,72
8002099378	TBL 4 2PL(110-220VAC/DC)	2 katlı ledli ve diyotlu 2 levels with led and diode	4	Gri / Grey	50	800	456,72
8002099428	TBL 4 2PK	2 katlı içeriden köprülü 2 levels internally bridged	4	Gri / Grey	50	800	291,53

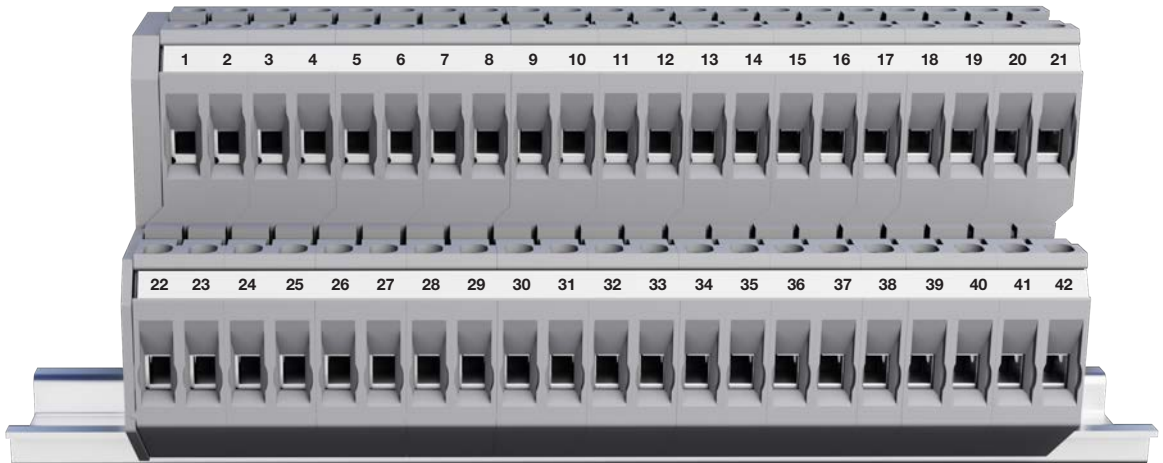

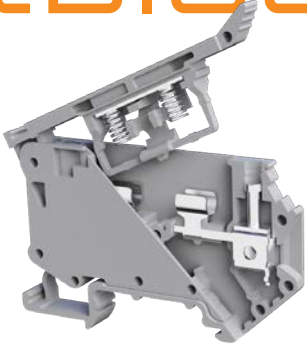

FDT 4 L



TBL 2,5 S



NTB 4 P+F

YENİ
NEW



Vida Bağlantılı Sigortalı ve Bıçaklı Ayırma Klemensleri

Screw Type Fuse and Disconnect Terminal Blocks

Ürün Kodu Product Code	Ürün Adı Product Name	Açıklama Explanation	Kesit Cross Sec. (mm ²)	Renk Color	Amb. Mik. Pack. Qty (Adet/Pcs.)	Koli Mik. Box.Qty. (Adet/Pcs.)	Birim Fiyatı Unit Price (TL/Adet)
8003099488	FDT 4	Sigortalı Ayırma Klemensi Fuse and Disconnect Terminal	4	Gri / Grey	25	500	195,20
8003099486	FDT 4	Sigortalı Ayırma Klemensi Fuse and Disconnect Terminal	4	Gri / Grey	25	500	195,20
8003099498	FDT 4 L (24-48 VAC/DC)	Sigortalı Ayırma Klemensi Fuse and Disconnect Terminal	4	Gri / Grey	25	500	422,50
8003099508	FDT 4 L (110-220 VAC/DC)	Sigortalı Ayırma Klemensi Fuse and Disconnect Terminal	4	Gri / Grey	25	500	422,50
8003099496	FDT 4 L (24-48 VAC/DC)	Sigortalı Ayırma Klemensi Fuse and Disconnect Terminal	4	Mavi / Blue	25	500	422,50
8003099506	FDT 4 L (110-220 VAC/DC)	Sigortalı Ayırma Klemensi Fuse and Disconnect Terminal	4	Mavi / Blue	25	500	422,50
8003098008	NTB 4 P+F Gri	Sigortalı Ayırma Klemensi Fuse and Disconnect Terminal	4	Gri / Grey	25	500	304,20
8003098018	NTB 4 P+F Gri (24-48 VAC/DC) Gri	Sigortalı Ayırma Klemensi Fuse and Disconnect Terminal	4	Gri / Grey	25	500	694,20
8003098028	NTB 4 P+F Gri (110-220 VAC/DC)Gri	Sigortalı Ayırma Klemensi Fuse and Disconnect Terminal	4	Gri / Grey	25	500	694,20
8003098038	NTB 4 P+F Gri (110-220VAC) Gri	Sigortalı Ayırma Klemensi Fuse and Disconnect Terminal	4	Gri / Grey	25	500	694,20
8003099528	TBL 2,5 S	Ayırma Klemensi Disconnect Terminal	2,5	Gri / Grey	50	900	167,31

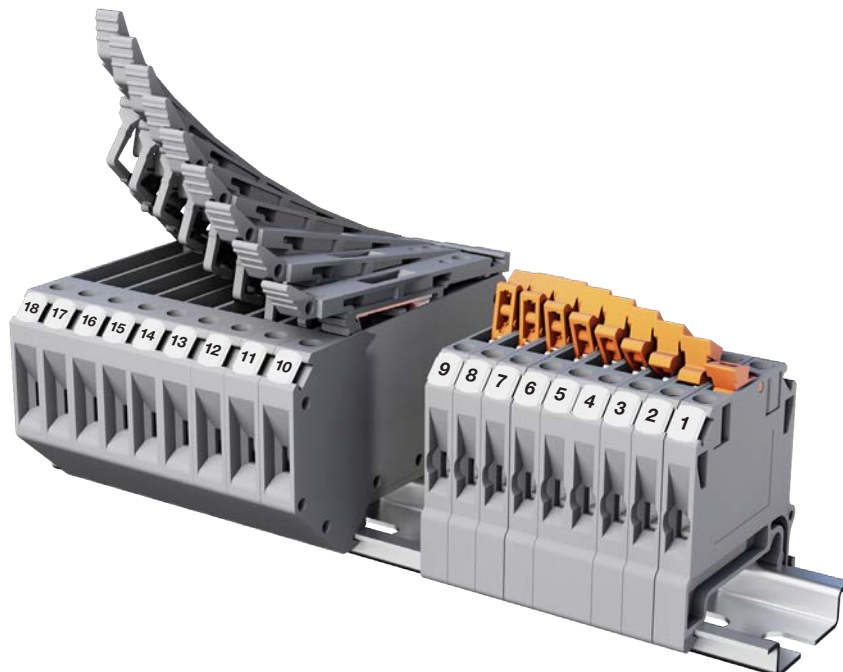

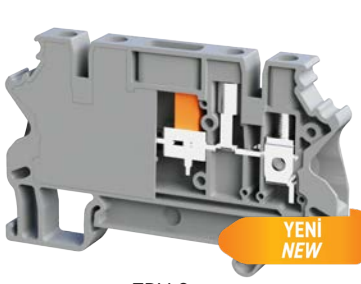

TDV 6

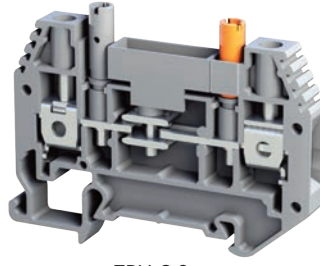

TDY-C 6

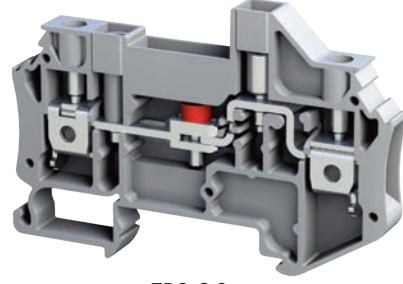





TDS-C 6



Vidalı Ölçme Ayırma Klemensleri

Screw Type Test and Disconnect Terminal Blocks

Ürün Kodu Product Code	Ürün Adı Product Name	Açıklama Explanation	Kesit Cross Sec. (mm ²)	Renk Color	Amb. Mik. Pack. Qty (Adet/Pcs.)	Koli Mik. Box.Qty. (Adet/Pcs.)	Birim Fiyatı Unit Price (TL/Adet)
8004099878	TDV-6 	Ölçme Ayırma Klemensi Test and Disconnect Terminal	6	Gri / Grey	25	500	397,80
8004099808	TDY-C 6 	Ölçme Ayırma Klemensi Test and Disconnect Terminal	6	Gri / Grey	20	320	388,70
8004099818	TDV-V 6	Ölçme Ayırma Klemensi Test and Disconnect Terminal	6	Gri / Grey	20	320	388,70
8004099828	TDS-C 6 	Ölçme Ayırma Klemensi Test and Disconnect Terminal	6	Gri / Grey	25	500	359,55
8004099838	TDV-C 6	Ölçme Ayırma Klemensi Test and Disconnect Terminal	6	Gri / Grey	25	500	359,55
8004099848	TDS-V 6 	Ölçme Ayırma Klemensi Test and Disconnect Terminal	6	Gri / Grey	25	500	359,55
8004099858	TDY-C 6	Ölçme Ayırma Klemensi Test and Disconnect Terminal	6	Gri / Grey	25	500	388,70

Ürün Kodu Product Code	Ürün Adı Product Name	Açıklama Explanation	Renk Color	Amb. Mik. Pack. Qty (Adet/Pcs.)	Birim Fiyatı Unit Price (TL/Adet)
8014001003	JH-TDV	TDV Serisi Üst Köprü Tutucu TDV Jumper Holder	Gri / Grey	1	---



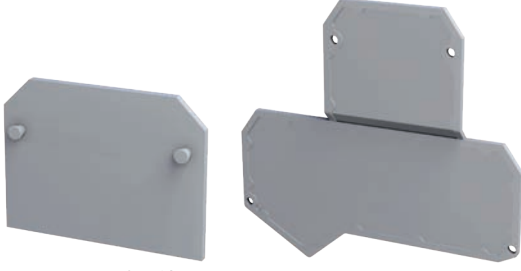

EPL TBL 2,5-10

EPL2 TBL 4 2P

Nihayet Plakaları

End Plates

Ürün Kodu Product Code	Ürün Adı Product Name	Açıklama Explanation	Kesit Cross Sec. (mm ²)	Renk Color	Amb. Mik. Pack. Qty (Adet/Pcs.)	Birim Fiyatı Unit Price (TL/Adet)
8012396288	EPL NTB 2,5-10	Nihayet Plakası / End Plate	2,5 - 10	Gri / Grey	50	27,89
8012396284	EPL NTB 2,5-10	Nihayet Plakası / End Plate	2,5 - 10	Sarı-Yeşil Green - Yellow	50	27,89
8012396388	EPL NTB 2,5- 4 2P, EPL NTB 2,5 P + E	Nihayet Plakası / End Plate	2,5 - 4	Gri / Grey	20	55,77
8012396118	EPL TBL 2,5-10	Nihayet Plakası / End Plate	2,5 - 10	Gri / Grey	50	26,03
8012396208	EPL TBL 2,5-4 2P	Nihayet Plakası / End Plate	2,5 - 4	Gri / Grey	20	51,13
8012396158	EPL TBL 2,5 2P+E	Nihayet Plakası / End Plate	2,5	Gri / Grey	20	44,00
8012396218	EPL1 TBL 4 2P	Nihayet Plakası / End Plate	4	Gri / Grey	20	54,11
8012396228	EPL2 TBL 4 2P	Nihayet Plakası / End Plate	4	Gri / Grey	20	54,11
8012396238	EPL3 TBL 4 2P	Nihayet Plakası / End Plate	4	Gri / Grey	20	54,11
8012396298	EPL TBL 10 2P	Nihayet Plakası / End Plate	10	Gri / Grey	10	52,99
8012396018	EPL TDS	Nihayet Plakası / End Plate	6	Gri / Grey	50	66,08
8012396028	EPL TDV	Nihayet Plakası / End Plate	6	Gri / Grey	50	66,08
8012396038	EPL TDY	Nihayet Plakası / End Plate	6	Gri / Grey	50	66,08

Renk Kodları / Color Codes

800009900....

...0	...1	...2	...3	...4	...5	...6	...9
------	------	------	------	------	------	------	------

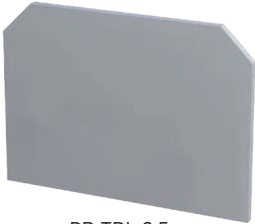

PR TBL 2,5



GPR



EPL2 TBL 4 2P

Ayırma Plakaları

Partition Plates

Ürün Kodu Product Code	Ürün Adı Product Name	Açıklama Explanation	Kesit Cross Sec. (mm ²)	Renk Color	Amb. Mik. Pack. Qty (Adet/Pcs.)	Birim Fiyatı Unit Price (TL/Adet)
8012396406	PR TBL 2,5-10	Ayırma Plakası / Partition Plate	2,5 - 10	Mavi / Blue	50	42,76
8012396408	PR TBL 2,5-10	Ayırma Plakası / Partition Plate	2,5 - 10	Gri / Grey	50	42,76
8012396508	PR TBL 4 2P	Ayırma Plakası / Partition Plate	4	Gri / Grey	20	52,99
8012396528	SPR 2,5-10	Ayırma Plakası / Partition Plate	2,5 - 10	Gri / Grey	100	24,17
8012396538	SPR 16-35	Ayırma Plakası / Partition Plate	16 - 35	Gri / Grey	50	54,85
8012396558	SPR TBL 4 2P	Ayırma Plakası / Partition Plate	4	Gri / Grey	100	30,86
8012396566	GPR	Genel Ayırma Plakası / General Partition Plate	16 -50	Mavi / Blue	20	69,72
8012396568	GPR	Genel Ayırma Plakası / General Partition Plate	16 -50	Gri / Grey	20	69,72
8012397038	PR PFT	Ayırma Plakası / Partition Plate	2,5 - 10	Gri / Grey	50	71,50



Test Fişleri

Test Sockets

Ürün Kodu Product Code	Ürün Adı Product Name	Açıklama Explanation	Renk Color	Amb. Mik. Pack. Qty (Adet/Pcs.)	Birim Fiyatı Unit Price (TL/Adet)
8014393106	TST-I 1 ●	Test Fişi / Test Plug	Mavi / Blue	50	68,60
8014393104	TST-I 1 ●	Test Fişi / Test Plug	Sarı / Yellow	50	68,60
8014393108	TST-I 1 ●	Test Fişi / Test Plug	Gri / Grey	50	68,60
8014393102	TST-I 1 ●	Test Fişi / Test Plug	Kırmızı / Red	50	68,60
8014393100	TST-I 1 ●	Test Fişi / Test Plug	Siyah / Black	50	68,60
8014393227	TST 1	Test Fişi / Test Plug		50	60,24
8014393237	TST 2	Test Fişi / Test Plug		50	60,24
8014393247	TST 3	Test Fişi / Test Plug		50	60,24
8014393257	TST 4	Test Fişi / Test Plug		50	60,24
8014394250	TFT 4 ●	TDV 6 Klemensi için Test Fişi / Test Socket For TDV 6	Siyah / Black	10	580,00

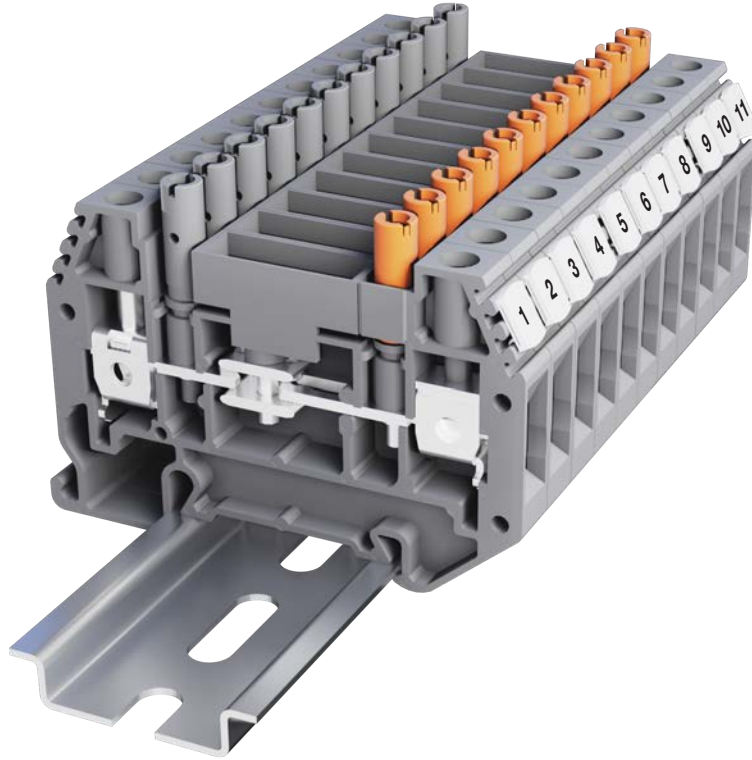



Üst Köprüler

Cross Connections

Ürün Kodu Product Code	Ürün Adı Product Name	Açıklama Explanation	Pin Pole	Kesit Cross Sec. (mm ²)	Amb. Mik. Pack. Qty (Adet/Pcs.)	Birim Fiyatı Unit Price (TL/Adet)
8013095023	SCC 2,5/2	TBL Serisi Vidalı Üst Köprü / TBL Series Screw Cross Connection	2	2,5	50	56,67
8013095033	SCC 2,5/3	TBL Serisi Vidalı Üst Köprü / TBL Series Screw Cross Connection	3	2,5	50	87,70
8013095003	SCC 2,5/10	TBL Serisi Vidalı Üst Köprü / TBL Series Screw Cross Connection	10	2,5	10	258,26
8013095123	SCC 4/2	TBL Serisi Vidalı Üst Köprü / TBL Series Screw Cross Connection	2	4	50	69,68
8013095133	SCC 4/3	TBL Serisi Vidalı Üst Köprü / TBL Series Screw Cross Connection	3	4	50	108,11
8013095103	SCC 4/10	TBL Serisi Vidalı Üst Köprü / TBL Series Screw Cross Connection	10	4	10	284,28
8013095223	SCC 6/2	TBL Serisi Vidalı Üst Köprü / TBL Series Screw Cross Connection	2	6	50	72,07
8013095233	SCC 6/3	TBL Serisi Vidalı Üst Köprü / TBL Series Screw Cross Connection	3	6	50	93,09
8013095203	SCC 6/10	TBL Serisi Vidalı Üst Köprü / TBL Series Screw Cross Connection	10	6	10	278,28
8013095323	SCC 10/2	TBL Serisi Vidalı Üst Köprü / TBL Series Screw Cross Connection	2	6	50	85,29
8013095333	SCC 10/3	TBL Serisi Vidalı Üst Köprü / TBL Series Screw Cross Connection	3	10	50	111,11
8013095303	SCC 10/10	TBL Serisi Vidalı Üst Köprü / TBL Series Screw Cross Connection	10	10	10	324,32
8013095423	SCC 16/2	TBL Serisi Vidalı Üst Köprü / TBL Series Screw Cross Connection	2	10	20	111,72
8013095433	SCC 16/3	TBL Serisi Vidalı Üst Köprü / TBL Series Screw Cross Connection	3	16	20	144,14
8013095403	SCC 16/10	TBL Serisi Vidalı Üst Köprü / TBL Series Screw Cross Connection	10	16	10	474,47
8013095523	SCC 25/2	TBL Serisi Vidalı Üst Köprü / TBL Series Screw Cross Connection	2	16	20	108,11
8013095533	SCC 25/3	TBL Serisi Vidalı Üst Köprü / TBL Series Screw Cross Connection	3	25	20	150,15
8013095503	SCC 25/10	TBL Serisi Vidalı Üst Köprü / TBL Series Screw Cross Connection	10	25	10	454,45
8013095623	SCC 35/2	TBL Serisi Vidalı Üst Köprü / TBL Series Screw Cross Connection	2	25	20	142,54
8013095633	SCC 35/3	TBL Serisi Vidalı Üst Köprü / TBL Series Screw Cross Connection	3	35	20	194,59
8013095603	SCC 35/10	TBL Serisi Vidalı Üst Köprü / TBL Series Screw Cross Connection	10	35	10	570,57
8013095723	SCC 50/2	TBL Serisi Vidalı Üst Köprü / TBL Series Screw Cross Connection	2	50	10	309,31
8013095733	SCC 50/3	TBL Serisi Vidalı Üst Köprü / TBL Series Screw Cross Connection	3	50	10	432,43
8013095823	SCC 70/2	TBL Serisi Vidalı Üst Köprü / TBL Series Screw Cross Connection	2	70	10	615,62
8013095833	SCC 70/3	TBL Serisi Vidalı Üst Köprü / TBL Series Screw Cross Connection	3	70	10	795,80
8013095923	SCC 95/2	TBL Serisi Vidalı Üst Köprü / TBL Series Screw Cross Connection	2	95	10	555,56
8013095933	SCC 95/3	TBL Serisi Vidalı Üst Köprü / TBL Series Screw Cross Connection	3	95	10	690,69
8013094023	SCC 150/2	TBL Serisi Vidalı Üst Köprü / TBL Series Screw Cross Connection	2	150	10	852,85
8013094123	SCC 4/2 TBL 4 2P	TBL Serisi Vidalı Üst Köprü / TBL Series Screw Cross Connection	2	4	50	72,07
8013094133	SCC 4/3 TBL 4 2P	TBL Serisi Vidalı Üst Köprü / TBL Series Screw Cross Connection	3	4	50	103,50
8013094163	SCC 4/6 TBL 4 2P	TBL Serisi Vidalı Üst Köprü / TBL Series Screw Cross Connection	6	4	20	111,72
8013094103	SCC 4/10 TBL 4 2P	TBL Serisi Vidalı Üst Köprü / TBL Series Screw Cross Connection	10	4	10	273,27



TCC 4/3

TCC 4/10

Tarak Köprüler

Comb Connector

Ürün Kodu Product Code	Ürün Adı Product Name	Açıklama Explanation	Pin Pole	Kesit Cross Sec. (mm ²)	Renk Color	Amb. Mik. Pack. Qty (Adet/Pcs.)	Birim Fiyatı Unit Price (TL/Adet)
8013094323	TCC 4/2	Tarak Köprü Köprü / Comb Connector	2	4	Gri / Gray	50	36,65
8013094333	TCC 4/3	Tarak Köprü Köprü / Comb Connector	3	4	Gri / Gray	50	51,66
8013094303	TCC 4/10	Tarak Köprü Köprü / Comb Connector	10	4	Gri / Gray	10	176,18
8013094403	TCC 4/10 TBL 4 2P	Tarak Köprü Köprü / Comb Connector	10	4	Gri / Gray	10	176,18
8013394823	TCC 6/2	Tarak Köprü Köprü / Comb Connector	2	6	Gri / Gray	50	88,49
8013394833	TCC 6/3	Tarak Köprü Köprü / Comb Connector	3	6	Gri / Gray	50	122,52
8013394803	TCC 6/10	Tarak Köprü Köprü / Comb Connector	10	6	Gri / Gray	10	435,44



SLC 2



SLC-R 4

Kayar Köprüler

Sliding Connector

Ürün Kodu Product Code	Ürün Adı Product Name	Açıklama Explanation	Pin Pole	Kesit Cross Sec. (mm ²)	Amb. Mik. Pack. Qty (Adet/Pcs.)	Birim Fiyatı Unit Price (TL/Adet)
8013394923	SLC 2	TD Serisi Klemensler için Üst Köprü Cross Connection for TD Series	2	6	50	39,04
8013394933	SLC 3	TD Serisi Klemensler için Üst Köprü Cross Connection for TD Series	3	6	50	52,61
8013394943	SLC 4	TD Serisi Klemensler için Üst Köprü Cross Connection for TD Series	4	6	50	74,56
8014393307	SLC-R 2	Test Fişi / Test Plug	2	6	50	112,85
8014393317	SLC-R 3	Test Fişi / Test Plug	3	6	50	150,58
8014393327	SLC-R 4	Test Fişi / Test Plug	4	6	50	221,98

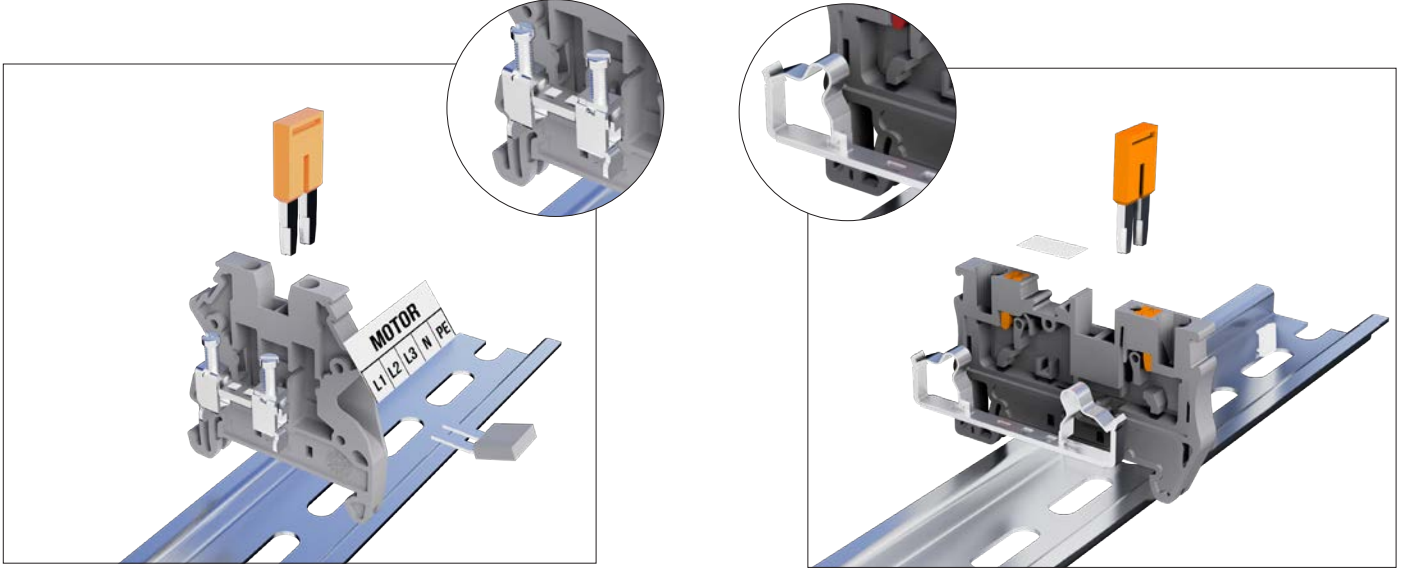

Vida Bağlantısı

Vidalı bağlantı bilinen en klasik bağlantı yöntemidir. Isıl işlem ile güçlendirilmiş sac ayaklar sayesinde uzun dönemde güvenli ve dayanıklı saha kullanımı mümkündür.

Güvenilir Bağlantı Ünitesi

Vidalı klemenslerde yer alan bağlantı ünitesi de (klemens ayağı), vidalarda olduğu gibi güçlendirilmiş çelikten üretilmektedir. Vida sıkıldığında bağlantı ünitesinde meydana gelen kuvvet bir kilitleme mekanizması oluşturur. Bu sistem sayesinde, uzun ömürlü ve güvenli bağlantı elde edilmektedir.

Push-in Bağlantı

Tbloc push-in klemensler, herhangi bir alet kullanmaksızın kolay ve hızlı montaj avantajı sağlamaktadır. Bu bağlantı teknolojisi sayesinde; tek damarlı kablolar ön hazırlığa gerek duymaksızın, çok damarlı kablolar da yüküklü olarak kolayca montajlanabilir. Ayrıca klemens üzerinde yer alan kırmızı butonlar, kullanıcıya klemensin iletken kısımlarına temas etmeden demontaj avantajı sağlamaktadır. Push-in bağlantılı klemensler titreşime karşı dayanıklıdır.

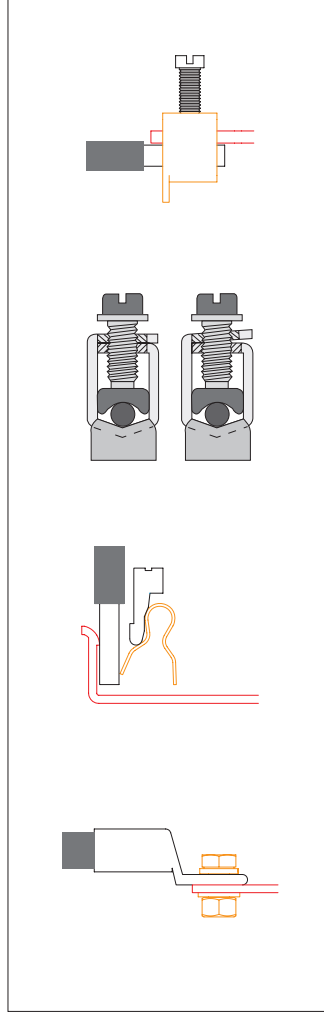

Screw Connection

Screw type connection is the classical method for terminal blocks. Reinforced clamps ensures the safe and durable connection for long time of usage.

Reliable Clamping

The connection unit (yokes) in the terminal block is made of reinforced steel, as in the screw. When the screw is tightened, the force that occurs in the connection unit creates a locking mechanism. Thanks to that, durable and safe connection is obtained.

Push-in Connection

Tbloc push-in terminal blocks provide fast assembly of cables without using a tool. With this technology, solid conductors (just stripping is enough) and flexible conductors (with end ferrules) can be assembled easily. Red buttons on top of the terminal blocks provide easy disassembly without touching conductive parts of the terminal blocks. Push-in connection is resistant to vibration hence can be used safely in many areas.



push-in klemmsler

push-in terminal blocks



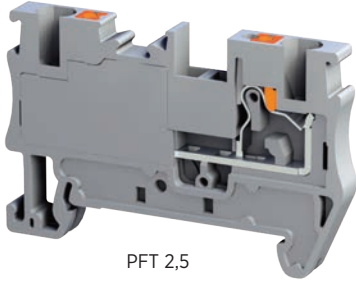

PFT 2,5

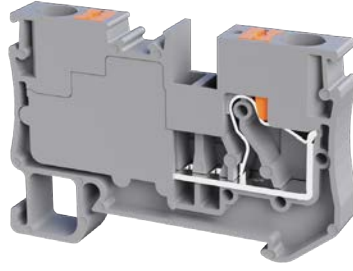

PFT 6



PFT Serisi Push-in Geçiş Klemensleri

PFT Series Push-in Feed Through Terminal Blocks

Ürün Kodu Product Code	Ürün Adı Product Name	Açıklama Explanation	Kesit Cross Sec. (mm ²)	Renk Color	Amb. Mik. Pack. Qty (Adet/Pcs.)	Koli Mik. Box.Qty. (Adet/Pcs.)	Birim Fiyatı Unit Price (TL/Adet)
8000298008	PFT 2,5	Geçiş Klemensi / Feed Through Terminal	2,5	Gri / Grey	100	1.000	40,52
8000298018	PFT 4	Geçiş Klemensi / Feed Through Terminal	4	Gri / Grey	100	800	55,60
8000298028	PFT 6	Geçiş Klemensi / Feed Through Terminal	6	Gri / Grey	50	500	90,96
8000298038	PFT 10	Geçiş Klemensi / Feed Through Terminal	10	Gri / Grey	30	600	146,33
8000298043*	PFT 16	Geçiş Klemensi / Feed Through Terminal	16	Gri / Grey	25	500	267,36

Renk Kodları / Color Codes

800009900....

...0

...1

...2

...3

...4

...5

...6

...9

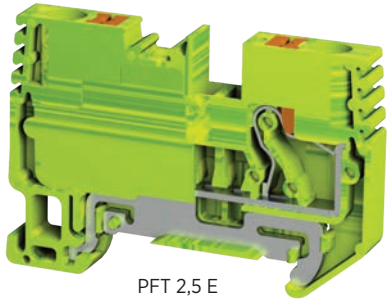

PFT 2,5 E

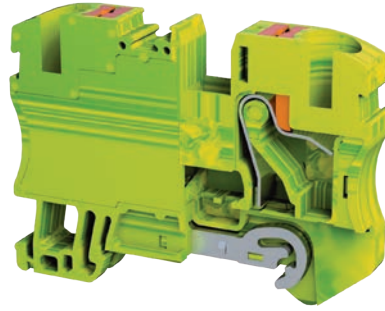

PFT 10 E



PFT Serisi Push-in Topraklama Klemensleri

PFT Series Push-in Earth Terminal Blocks

Ürün Kodu Product Code	Ürün Adı Product Name	Açıklama Explanation	Kesit Cross Sec. (mm ²)	Renk Color	Amb. Mik. Pack. Qty (Adet/Pcs.)	Koli Mik. Box.Qty. (Adet/Pcs.)	Birim Fiyatı Unit Price (TL/Adet)
8001298064	PFT 2,5 E	Topraklama Klemensi / Earth Terminal	2,5	Sarı-Yeşil / Yellow-Green	50	500	169,08
8001298074	PFT 4 E	Topraklama Klemensi / Earth Terminal	4	Sarı-Yeşil / Yellow-Green	50	500	213,79
8001298084	PFT 6 E	Topraklama Klemensi / Earth Terminal	6	Sarı-Yeşil / Yellow-Green	25	500	287,64
8001298104	PFT 10 E	Topraklama Klemensi / Earth Terminal	10	Sarı-Yeşil / Yellow-Green	30	600	387,55
8001298114	PFT 16 E	Topraklama Klemensi / Earth Terminal	16	Sarı-Yeşil / Yellow-Green	25	600	514,10

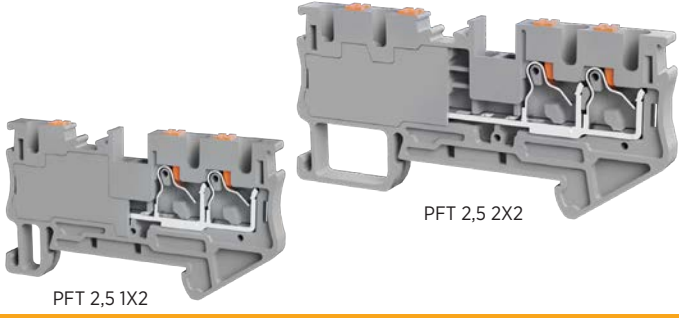

PFT Serisi Push-in Çok Girişli ve Çıkışlı Klemensler

PFT Series Push-in Multilevel Terminal Blocks

Ürün Kodu Product Code	Ürün Adı Product Name	Açıklama Explanation	Kesit Cross Sec. (mm ²)	Renk Color	Amb. Mik. Pack. Qty (Adet/Pcs.)	Koli Mik. Box.Qty. (Adet/Pcs.)	Birim Fiyatı Unit Price (TL/Adet)
8000298068	PFT 2,5 1X2	1 Giriş 2 Çıkış Geçiş Klemensi 1 Input 2 Output Feed Through Terminal	2,5	Gri / Grey	40	400	97,88
8000298060	PFT 2,5 1X2	1 Giriş 2 Çıkış Geçiş Klemensi 1 Input 2 Output Feed Through Terminal	2,5	Siyah / Black	40	400	97,88
8000298066	PFT 2,5 1X2	1 Giriş 2 Çıkış Geçiş Klemensi 1 Input 2 Output Feed Through Terminal	2,5	Mavi/Blue	40	400	97,88
8000298078	PFT 2,5 2X2	2 Giriş 2 Çıkış Geçiş Klemensi 2 Input 2 Output Feed Through Terminal	2,5	Gri / Grey	40	400	124,59
8000298076	PFT 2,5 2X2	2 Giriş 2 Çıkış Geçiş Klemensi 2 Input 2 Output Feed Through Terminal	2,5	Mavi/Blue	40	400	124,59
8000298168	PFT 4 1X2	1 Giriş 2 Çıkış Geçiş Klemensi 2 Input 2 Output Feed Through Terminal	4	Gri / Grey	40	400	159,00
8000298166	PFT 4 1X2	1 Giriş 2 Çıkış Geçiş Klemensi 2 Input 2 Output Feed Through Terminal	4	Mavi/Blue	40	400	159,00
8000298178	PFT 4 2X2	2 Giriş 2 Çıkış Geçiş Klemensi 2 Input 2 Output Feed Through Terminal	4	Gri / Grey	40	400	190,00
8000298176	PFT 4 2X2	2 Giriş 2 Çıkış Geçiş Klemensi 2 Input 2 Output Feed Through Terminal	4	Mavi/Blue	40	400	190,00

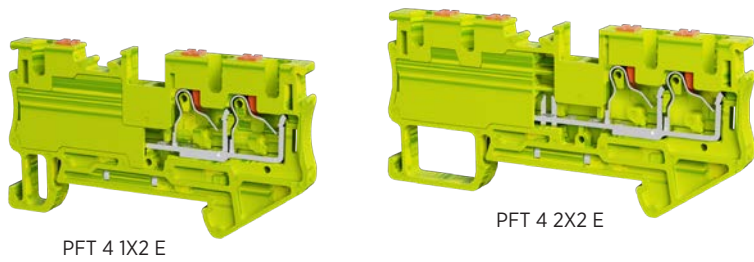

PFT Serisi Push-in Çok Girişli ve Çıkışlı Topraklı Klemensler

PFT Series Push-in Multilevel Earth Terminal Blocks

Ürün Kodu Product Code	Ürün Adı Product Name	Açıklama Explanation	Kesit Cross Sec. (mm ²)	Renk Color	Amb. Mik. Pack. Qty (Adet/Pcs.)	Koli Mik. Box.Qty. (Adet/Pcs.)	Birim Fiyatı Unit Price (TL/Adet)
8001298065	PFT 2,5 1X2 E	1 Giriş 2 Çıkış Topraklama Klemensi 1 Input 2 Output Earth Terminal	2,5	Sarı-Yeşil / Yellow-Green	40	400	260,00
8001298066	PFT 2,5 2X2 E	2 Giriş 2 Çıkış Topraklama Klemensi 2 input 2 Output Earth Terminal	2,5	Sarı-Yeşil / Yellow-Green	40	400	299,00
8001298165	PFT 4 1X2 E	1 Giriş 2 Çıkış Topraklama Klemensi 1 Input 2 Output Earth Terminal	4	Sarı-Yeşil / Yellow-Green	40	400	247,00
8001298166	PFT 4 2X2 E	2 Giriş 2 Çıkış Topraklama Klemensi 2 input 2 Output Earth Terminal	4	Sarı-Yeşil / Yellow-Green	30	540	286,00

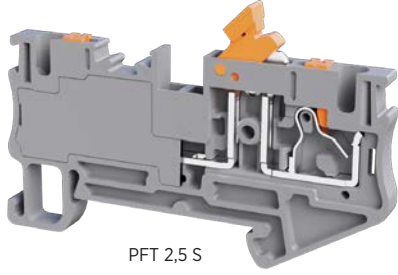

PFT 2,5 S

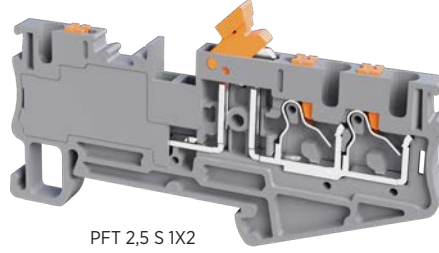

PFT 2,5 S 1x2

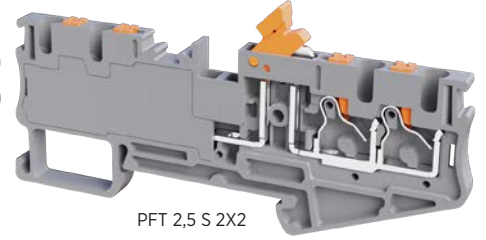

PFT 2,5 S 2x2

PFT Serisi Push-in Bıçaklı Ayırma Klemensleri

PFT Series Push-in Disconnect Terminal Blocks

Ürün Kodu Product Code	Ürün Adı Product Name	Açıklama Explanation	Kesit Cross Sec. (mm ²)	Renk Color	Amb. Mik. Pack. Qty (Adet/Pcs.)	Koli Mik. Box.Qty. (Adet/Pcs.)	Birim Fiyatı Unit Price (TL/Adet)
8003200508	PFT 2,5 S	Ayrırma Klemensi Disconnect Terminal Block	2,5	Gri / Grey	40	400	299,00
8003200518	PFT 2,5 S 1x2	Ayrırma Klemensi Disconnect Terminal Block	2,5	Gri / Grey	40	400	357,50
8003200528	PFT 2,5 S 2x2	Ayrırma Klemensi Disconnect Terminal Block	2,5	Gri / Grey	40	400	429,00

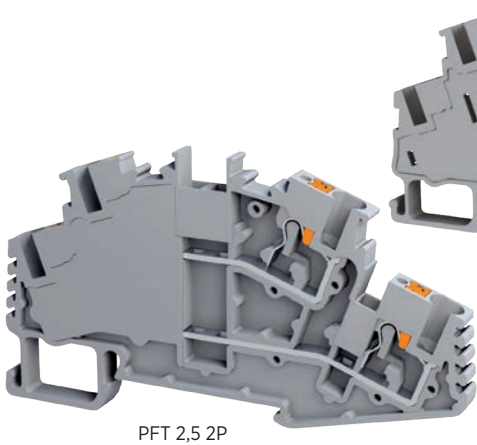

PFT 2,5 2P

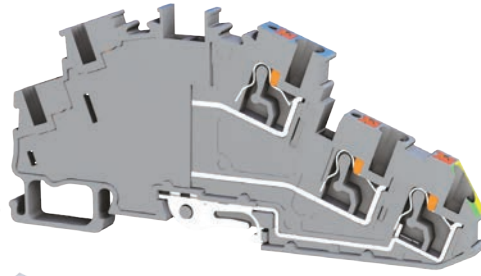

PFT 2,5 2P+E
(Linye Klemensi)

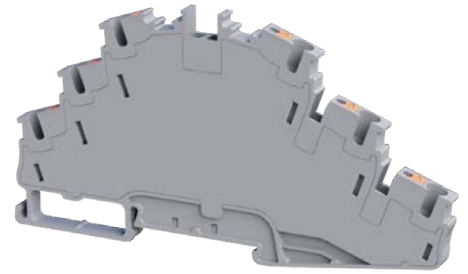

PFT 2,5 3P

PFT Serisi Push-in Çok Katlı Klemensler

PFT Series Push-in Multilevel Terminal Blocks

Ürün Kodu Product Code	Ürün Adı Product Name	Açıklama Explanation	Kesit Cross Sec. (mm ²)	Renk Color	Amb. Mik. Pack. Qty (Adet/Pcs.)	Koli Mik. Box.Qty. (Adet/Pcs.)	Birim Fiyatı Unit Price (TL/Adet)
8002298098	PFT 2,5 2P	Çok Katlı Klemens / Multilevel Terminal	2,5	Gri / Grey	50	500	110,73
8002298096	PFT 2,5 2P	Çok Katlı Klemens / Multilevel Terminal	2,5	Mavi/Blue	50	500	110,73
8002298198	PFT 2,5 3P	Çok Katlı Klemens / Multilevel Terminal	2,5	Gri / Grey	28	600	278,85
8002298118	PFT 4 2P	Çok Katlı Klemens / Multilevel Terminal	4	Gri / Grey	50	500	156,16
8002298108	PFT 2,5 2P+E	Çok Katlı Klemens + Topraklama Multilevel Terminal + Earth	2,5	Gri / Grey	30	600	321,78

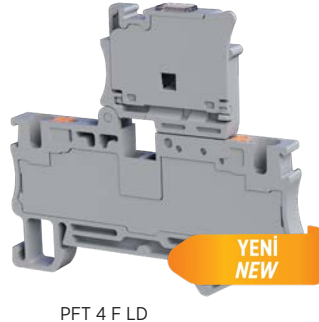
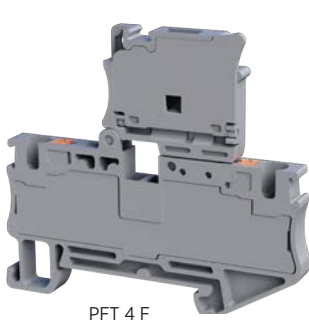

PFT Serisi Push-in Bıçaklı Ayırma Klemensleri

PFT Series Push-in Disconnect Terminal Blocks

Ürün Kodu Product Code	Ürün Adı Product Name	Açıklama Explanation	Kesit Cross Sec. (mm ²)	Renk Color	Amb. Mik. Pack. Qty (Adet/Pcs.)	Koli Mik. Box.Qty. (Adet/Pcs.)	Birim Fiyatı Unit Price (TL/Adet)
8003298488	PFT 4 F	Ayırma Klemensi Disconnect Terminal Block	4	Gri / Grey	70	700	205,00
8003298486	PFT 4 F	Ayırma Klemensi Disconnect Terminal Block	4	Mavi/Blue	70	700	205,00
8003298498	PFT 4 F LD (24-48 VAC/DC)	Ayırma Klemensi Disconnect Terminal Block	4	Gri / Grey	70	700	445,00
8003298496	PFT 4 F LD (24-48 VAC/DC)	Ayırma Klemensi Disconnect Terminal Block	4	Mavi/Blue	70	700	445,00
8003298508	PFT 4 F LD (110-220 VAC/DC)	Ayırma Klemensi Disconnect Terminal Block	4	Gri / Grey	70	700	445,00
8003298506	PFT 4 F LD (110-220 VAC/DC)	Ayırma Klemensi Disconnect Terminal Block	4	Mavi/Blue	70	700	445,00

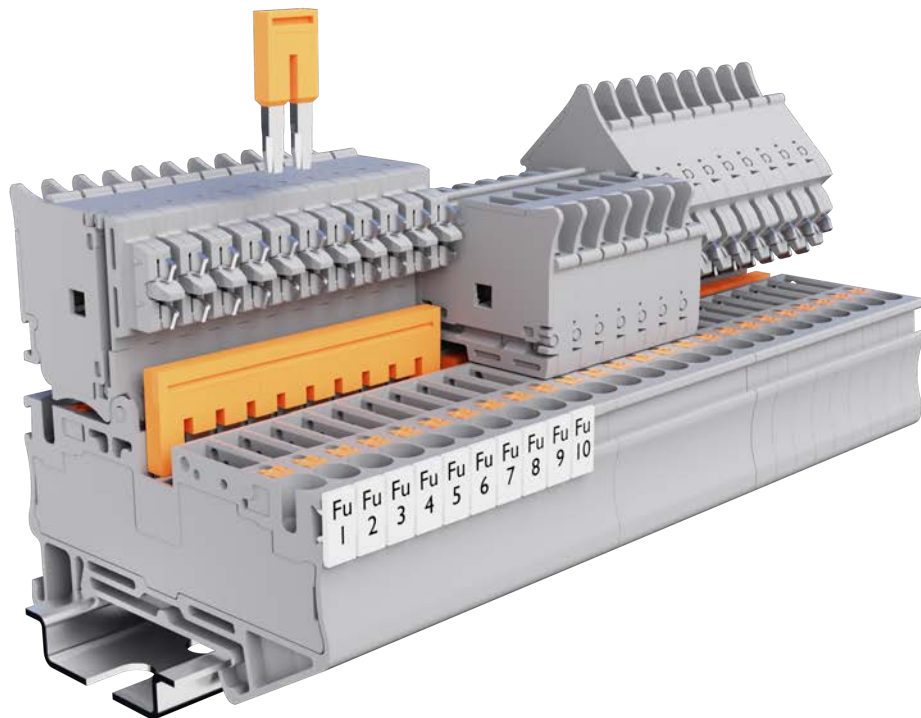



Üst Köprüler

Push-in Cross Connections

Ürün Kodu Product Code	Ürün Adı Product Name	Pin Pole	Açıklama Explanation	Kesit Cross Sec. (mm ²)	Renk Color	Amb. Mik. Pack. Qty (Adet/Pcs.)	Birim Fiyatı Unit Price (TL/Adet)
8013294523	PCC 2,5/2	2	PFT ve NTB Serisi Üst Köprü PFT and NTB Series Cross Connections	2,5	Turuncu / Orange	100	35,59
8013294533	PCC 2,5/3	3	PFT ve NTB Serisi Üst Köprü PFT and NTB Series Cross Connections	2,5	Turuncu / Orange	100	53,39
8013294503	PCC 2,5/10	10	PFT ve NTB Serisi Üst Köprü PFT and NTB Series Cross Connections	2,5	Turuncu / Orange	10	177,96
8013294623	PCC 4/2	2	PFT ve NTB Serisi Üst Köprü PFT and NTB Series Cross Connections	4	Turuncu / Orange	100	42,52
8013294633	PCC 4/3	3	PFT ve NTB Serisi Üst Köprü PFT and NTB Series Cross Connections	4	Turuncu / Orange	100	63,28
8013294603	PCC 4/10	10	PFT ve NTB Serisi Üst Köprü PFT and NTB Series Cross Connections	4	Turuncu / Orange	10	207,62
8013294723	PCC 6/2	2	PFT ve NTB Serisi Üst Köprü PFT and NTB Series Cross Connections	6	Turuncu / Orange	50	49,83
8013294733	PCC 6/3	3	PFT ve NTB Serisi Üst Köprü PFT and NTB Series Cross Connections	6	Turuncu / Orange	50	74,75
8013294703	PCC 6/10	10	PFT ve NTB Serisi Üst Köprü PFT and NTB Series Cross Connections	6	Turuncu / Orange	10	249,14
8013295703	PCC 6/10-T	10	NTB Serisi Üst Köprü NTB Series Cross Connections	6	Turuncu / Orange	10	253,50
8013294823	PCC 10/2	2	PFT ve NTB Serisi Üst Köprü PFT and NTB Series Cross Connections	10	Turuncu / Orange	10	97,18
8013294833	PCC 10/3	3	PFT ve NTB Serisi Üst Köprü PFT and NTB Series Cross Connections	10	Turuncu / Orange	10	139,43
8013294923	PCC 16/2	2	PFT Serisi Üst Köprü PFT Series Cross Connections	16	Turuncu / Orange	10	120,84



SRK 16/3



SRK 16/8

Sıra Klemensler

Terminal Strips

Ürün Kodu Product Code	Ürün Adı Product Name	Açıklama Explanation	Kutup Sayısı Number of Poles	Renk Color	Amb. Mik. Pack. Qty (Adet/Pcs.)	Birim Fiyatı Unit Price (TL/Adet)
8006097008	SRK 16/2	Sıra Klemens / Terminal Strips	2	Gri / Grey	96	100,39
8006097018	SRK 16/3	Sıra Klemens / Terminal Strips	3	Gri / Grey	32	146,86
8006097028	SRK 16/4	Sıra Klemens / Terminal Strips	4	Gri / Grey	48	194,69
8006097038	SRK 16/5	Sıra Klemens / Terminal Strips	5	Gri / Grey	32	243,36
8006097048	SRK 16/6	Sıra Klemens / Terminal Strips	6	Gri / Grey	30	281,89
8006097058	SRK 16/8	Sıra Klemens / Terminal Strips	8	Gri / Grey	24	375,18
8006097068	SRK 16/10	Sıra Klemens / Terminal Strips	10	Gri / Grey	16	456,30
8006097078	SRK 16/12	Sıra Klemens / Terminal Strips	12	Gri / Grey	8	583,05

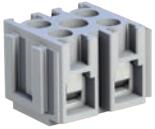

CSK 2,5

Cihaz Sıra Klemensler

Modular Terminal Strips

Ürün Kodu Product Code	Ürün Adı Product Name	Açıklama Explanation	Kesit Cross Sec. (mm ²)	Renk Color	Amb. Mik. Pack. Qty (Adet/Pcs.)	Birim Fiyatı Unit Price (TL/Adet)
8006097108	CSK 2,5	Cihaz Sıra Klemens / Modular Terminal Strips	2,5	Gri / Grey	100	49,69
8006097118	CSK 6	Cihaz Sıra Klemens / Modular Terminal Strips	6	Gri / Grey	60	82,13

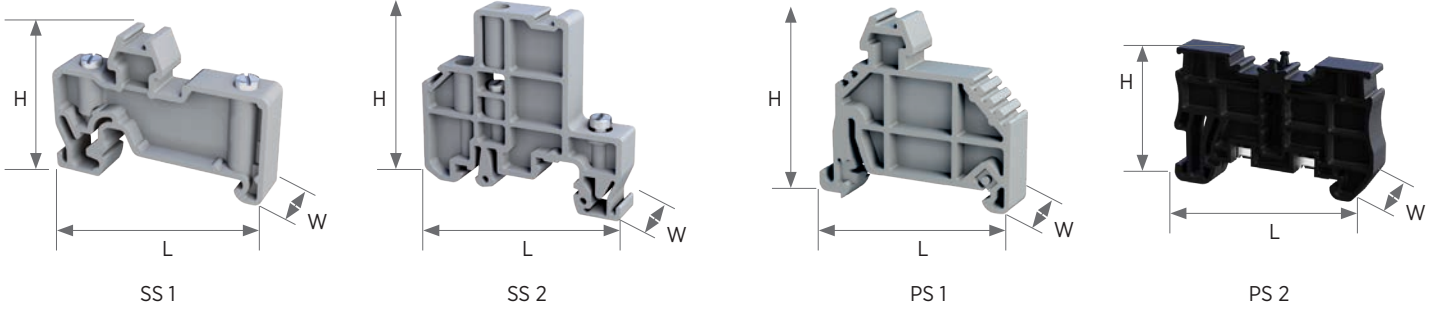

Durdurucu

End Bracket

Ürün Kodu Product Code	Ürün Adı Product Name	Açıklama Explanation	Ebatlar Dimension (W/H/L)(mm)	Renk Color	Amb. Mik. Pack. Qty (Adet/Pcs.)	Birim Fiyatı Unit Price (TL/Adet)
8010097308	SS 1	Durdurucu (Vidalı) / End Bracket (Screw)	8/30,7/26,8	Gri / Grey	50	36,26
8010097318	SS 2	Durdurucu (Vidalı) / End Bracket (Screw)	10/50/50,5	Gri / Grey	50	37,18
8010197328	PS 1	Durdurucu (Yaylı) / End Bracket (Spring)	10/42,8/45,6	Gri / Grey	50	36,26
8010197428	PS 2	Durdurucu (Yaylı) / End Bracket (Spring)	8/35/53,6	Gri / Grey	50	36,26
8010197420	PS 2	Durdurucu (Yaylı) / End Bracket (Spring)	8/35/53,6	Siyah/ Black	50	36,26

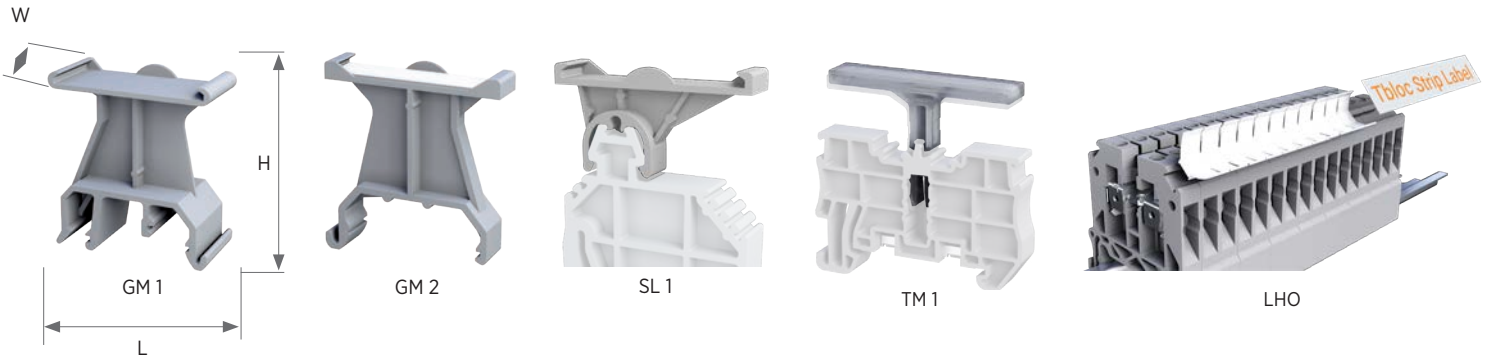

Grup Etiketi

Group Marker

Ürün Kodu Product Code	Ürün Adı Product Name	Açıklama Explanation	Ebatlar Dimension (W/H/L)(mm)	Renk Color	Amb. Mik. Pack. Qty (Adet/Pcs.)	Birim Fiyatı Unit Price (TL/Adet)
8014393008	GM 1	Grup Etiketi / Group Marker	19,5/47/43,7	Gri / Grey	50	51,13
8014393018	GM 2	Grup Etiketi / Group Marker	9,5/47/44,4	Gri / Grey	50	49,65
8012396008	SL 1	Grup Etiketi / Group Marker	9,5/43,7/22,6	Gri / Grey	50	57,55
8020390009	LHO	Şerit Etiket Tutucu / Strip Label Holder	---	Beyaz / White	10	13,17
8014393020	TM 1	PS 2 Şeffaf Etiket Kılıfı / PS 2 Transpered Label Holder	8/45/29,2	Şeffaf Transtered	50	34,46

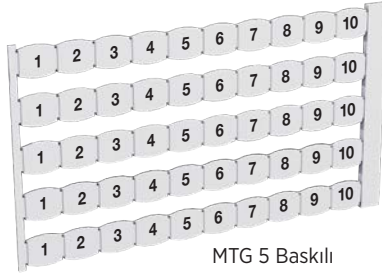

MTG 5 Baskılı



MTG 5 Baskısız

Ürün Kodu Product Code	Ürün Adı Product Name	Açıklama Description	Plaka Miktarı Plate Qty (Adet/Pcs.)	Amb. Mik. Pack. Qty (Plaka-Plates/Pcs.)	Plaka Fiyatı Plate Price (TL)	Adet Fiyatı Pcs. Price (TL/Adet)
8020389019	MTG 5 Baskılı	Baskılı / Printed	50	500	1185,00	2,37
8020389009	MTG 5 Baskısız	Boş / Empty	50	500	930,00	1,86
8020389029	MTG 5 (1-10)	1-10	50	500	1185,00	2,37
8020389039	MTG 5 (11-20)	11-20	50	500	1185,00	2,37
8020389049	MTG 5 (21-30)	21-30	50	500	1185,00	2,37
8020389059	MTG 5 (31-40)	31-40	50	500	1185,00	2,37
8020389069	MTG 5 (41-50)	41-50	50	500	1185,00	2,37
8020389079	MTG 5 (51-60)	51-60	50	500	1185,00	2,37
8020389089	MTG 5 (61-70)	61-70	50	500	1185,00	2,37
8020389099	MTG 5 (71-80)	71-80	50	500	1185,00	2,37
8020389109	MTG 5 (81-90)	81-90	50	500	1185,00	2,37
8020389119	MTG 5 (91-100)	91-100	50	500	1185,00	2,37
8020389129	MTG 5 (1-50)	1-50	50	500	1185,00	2,37
8020389139	MTG 5 (51-100)	51-100	50	500	1185,00	2,37
8020389149	MTG 5 (101-150)	101-150	50	500	1185,00	2,37
8020389159	MTG 5 (151-200)	151-200	50	500	1185,00	2,37
8020389169	MTG 5 (201-250)	201-250	50	500	1185,00	2,37
8020389179	MTG 5 (251-300)	251-300	50	500	1185,00	2,37
8020389189	MTG 5 (301-350)	301-350	50	500	1185,00	2,37
8020389199	MTG 5 (351-400)	351-400	50	500	1185,00	2,37
8020389209	MTG 5 (401-450)	401-450	50	500	1185,00	2,37
8020389219	MTG 5 (451-500)	451-500	50	500	1185,00	2,37
8020388019	MTG 6 Baskılı	Baskılı / Printed	50	500	1285,00	2,57
8020388009	MTG 6 Baskısız	Boş / Empty	50	500	1045,00	2,09
8020388839	MTG 6 (L1, L2, L3, N)	L1, L2, L3, N	50	500	1285,00	2,57
8020388309	MTG 6 (0)	0	50	500	1285,00	2,57
8020388319	MTG 6 (1)	1	50	500	1285,00	2,57
8020388599	MTG 6 (S)	S	50	500	1285,00	2,57
8020388329	MTG 6 (2)	2	50	500	1285,00	2,57
8020388339	MTG 6 (3)	3	50	500	1285,00	2,57
8020388349	MTG 6 (4)	4	50	500	1285,00	2,57
8020388359	MTG 6 (5)	5	50	500	1285,00	2,57
8020388369	MTG 6 (6)	6	50	500	1285,00	2,57
8020388379	MTG 6 (7)	7	50	500	1285,00	2,57
8020388389	MTG 6 (8)	8	50	500	1285,00	2,57
8020388399	MTG 6 (9)	9	50	500	1285,00	2,57
8020388409	MTG 6 (10)	10	50	500	1285,00	2,57
8020388029	MTG 6 (0-9)	0-9	50	500	1285,00	2,57
8020388039	MTG 6 (1-10)	1-10	50	500	1285,00	2,57
8020388879	MTG 6 (11-20)	11-20	50	500	1285,00	2,57
8020388889	MTG 6 (21-30)	21-30	50	500	1285,00	2,57
8020388899	MTG 6 (31-40)	31-40	50	500	1285,00	2,57
8020388909	MTG 6 (41-50)	41-50	50	500	1285,00	2,57
8020388919	MTG 6 (51-60)	51-60	50	500	1285,00	2,57
8020388929	MTG 6 (61-70)	61-70	50	500	1285,00	2,57
8020388939	MTG 6 (71-80)	71-80	50	500	1285,00	2,57
8020388949	MTG 6 (81-90)	81-90	50	500	1285,00	2,57
8020388959	MTG 6 (91-100)	91-100	50	500	1285,00	2,57



MTG 6 Baskılı



MTG 6 Baskısız

Ürün Kodu Product Code	Ürün Adı Product Name	Açıklama Description	Plaka Miktarı Plate Qty (Adet/Pcs.)	Amb. Mik. Pack. Qty (Plaka-Plates/Pcs.)	Plaka Fiyatı Plate Price (TL)	Adet Fiyatı Pcs. Price (TL/Adet)
8020388049	MTG 6 (1-50)	1-50	50	500	1285,00	2,57
8020388059	MTG 6 (51-100)	51-100	50	500	1285,00	2,57
8020388069	MTG 6 (101-150)	101-150	50	500	1285,00	2,57
8020388079	MTG 6 (151-200)	151-200	50	500	1285,00	2,57
8020388089	MTG 6 (201-250)	201-250	50	500	1285,00	2,57
8020388099	MTG 6 (251-300)	251-300	50	500	1285,00	2,57
8020388109	MTG 6 (301-350)	301-350	50	500	1285,00	2,57
8020388119	MTG 6 (351-400)	351-400	50	500	1285,00	2,57
8020388129	MTG 6 (401-450)	401-450	50	500	1285,00	2,57
8020388139	MTG 6 (451-500)	451-500	50	500	1285,00	2,57
8020388149	MTG 6 (501-550)	501-550	50	500	1285,00	2,57
8020388159	MTG 6 (551-600)	551-600	50	500	1285,00	2,57
8020388169	MTG 6 (601-650)	601-650	50	500	1285,00	2,57
8020388179	MTG 6 (651-700)	651-700	50	500	1285,00	2,57
8020388189	MTG 6 (701-750)	701-750	50	500	1285,00	2,57
8020388199	MTG 6 (751-800)	751-800	50	500	1285,00	2,57
8020388209	MTG 6 (801-850)	801-850	50	500	1285,00	2,57
8020388219	MTG 6 (851-900)	851-900	50	500	1285,00	2,57
8020388229	MTG 6 (901-950)	901-950	50	500	1285,00	2,57
8020388239	MTG 6 (951-1000)	951-1000	50	500	1285,00	2,57
8020388859	MTG 6 (RSTN)	RSTN	50	500	1285,00	2,57
8020388779	MTG 6 (+)	+	50	500	1285,00	2,57
8020388789	MTG 6 (-)	-	50	500	1285,00	2,57
8020388429	MTG 6 (B)	B	50	500	1285,00	2,57
8020388849	MTG 6 (PE)	PE	50	500	1285,00	2,57
8020388459	MTG 6 (E)	E	50	500	1285,00	2,57
8020388529	MTG 6 (L)	L	50	500	1285,00	2,57
8020388549	MTG 6 (N)	N	50	500	1285,00	2,57
8020388659	MTG 6 (Y)	Y	50	500	1285,00	2,57
8020388589	MTG 6 (R)	R	50	500	1285,00	2,57
8020388829	MTG 6 (L1, L2, L3)	L1, L2, L3	50	500	1285,00	2,57
8020388799	MTG 6 (L1)	L1	50	500	1285,00	2,57
8020388809	MTG 6 (L2)	L2	50	500	1285,00	2,57
8020388499	MTG 6 (I)	I	50	500	1285,00	2,57
8020388449	MTG 6 (D)	D	50	500	1285,00	2,57
8020388519	MTG 6 (K)	K	50	500	1285,00	2,57
8020388469	MTG 6 (F)	F	50	500	1285,00	2,57
8020388419	MTG 6 (A)	A	50	500	1285,00	2,57
8020388539	MTG 6 (M)	M	50	500	1285,00	2,57
8020388569	MTG 6 (P)	P	50	500	1285,00	2,57
8020388679	MTG 6 (X1)	X1	50	500	1285,00	2,57
8020388689	MTG 6 (X2)	X2	50	500	1285,00	2,57
8020388699	MTG 6 (X3)	X3	50	500	1285,00	2,57
8020388709	MTG 6 (X4)	X4	50	500	1285,00	2,57
8020388719	MTG 6 (X5)	X5	50	500	1285,00	2,57
8020388729	MTG 6 (X6)	X6	50	500	1285,00	2,57
8020388739	MTG 6 (X7)	X7	50	500	1285,00	2,57
8020388749	MTG 6 (X8)	X8	50	500	1285,00	2,57

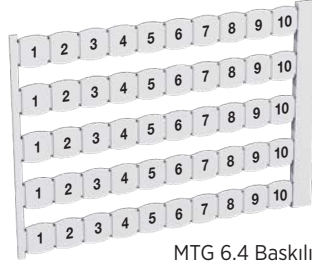

MTG 6.4 Baskılı



MTG 6.4 Baskısız

Ürün Kodu Product Code	Ürün Adı Product Name	Açıklama Description	Plaka Miktarı Plate Qty (Adet/Pcs.)	Amb. Mik. Pack. Qty (Plaka-Plates/Pcs.)	Plaka Fiyatı Plate Price (TL)	Adet Fiyatı Pcs. Price (TL/Adet)
8020388759	MTG 6 (X9)	X9	50	500	1285,00	2,57
8020388769	MTG 6 (X10)	X10	50	500	1285,00	2,57
8020388439	MTG 6 (C)	C	50	500	1285,00	2,57
8020388629	MTG 6 (V)	V	50	500	1285,00	2,57
8020388479	MTG 6 (G)	G	50	500	1285,00	2,57
8020388489	MTG 6 (H)	H	50	500	1285,00	2,57
8020388819	MTG 6 (L3)	L3	50	500	1285,00	2,57
8020388869	MTG 6 (MP)	MP	50	500	1285,00	2,57
8020388609	MTG 6 (T)	T	50	500	1285,00	2,57
8020387019	MTG 6,4 Baskılı	Baskılı / Printed	50	500	1385,00	2,77
8020387009	MTG 6,4 Baskısız	Boş / Empty	50	500	1190,00	2,38
8020387309	MTG 6,4 (1)	1	50	500	1385,00	2,77
8020387319	MTG 6,4 (2)	2	50	500	1385,00	2,77
8020387329	MTG 6,4 (3)	3	50	500	1385,00	2,77
8020387339	MTG 6,4 (4)	4	50	500	1385,00	2,77
8020387349	MTG 6,4 (5)	5	50	500	1385,00	2,77
8020387359	MTG 6,4 (6)	6	50	500	1385,00	2,77
8020387369	MTG 6,4 (7)	7	50	500	1385,00	2,77
8020387379	MTG 6,4 (8)	8	50	500	1385,00	2,77
8020387389	MTG 6,4 (9)	9	50	500	1385,00	2,77
8020387399	MTG 6,4 (10)	10	50	500	1385,00	2,77
8020387029	MTG 6,4 (0-9)	0-9	50	500	1385,00	2,77
8020387039	MTG 6,4 (1-50)	1-50	50	500	1385,00	2,77
8020387049	MTG 6,4 (51-100)	51-100	50	500	1385,00	2,77
8020387059	MTG 6,4 (101-150)	101-150	50	500	1385,00	2,77
8020387069	MTG 6,4 (151-200)	151-200	50	500	1385,00	2,77
8020387079	MTG 6,4 (201-250)	201-250	50	500	1385,00	2,77
8020387089	MTG 6,4 (251-300)	251-300	50	500	1385,00	2,77
8020387099	MTG 6,4 (301-350)	301-350	50	500	1385,00	2,77
8020387109	MTG 6,4 (351-400)	351-400	50	500	1385,00	2,77
8020387119	MTG 6,4 (401-450)	401-450	50	500	1385,00	2,77
8020387129	MTG 6,4 (451-500)	451-500	50	500	1385,00	2,77
8020387139	MTG 6,4 (501-550)	501-550	50	500	1385,00	2,77
8020387149	MTG 6,4 (551-600)	551-600	50	500	1385,00	2,77
8020387159	MTG 6,4 (601-650)	601-650	50	500	1385,00	2,77
8020387169	MTG 6,4 (651-700)	651-700	50	500	1385,00	2,77
8020387179	MTG 6,4 (701-750)	701-750	50	500	1385,00	2,77
8020387189	MTG 6,4 (751-800)	751-800	50	500	1385,00	2,77
8020387199	MTG 6,4 (801-850)	801-850	50	500	1385,00	2,77
8020387209	MTG 6,4 (851-900)	851-900	50	500	1385,00	2,77
8020387219	MTG 6,4 (901-950)	901-950	50	500	1385,00	2,77
8020387229	MTG 6,4 (951-1000)	951-1000	50	500	1385,00	2,77
8020387239	MTG 6,4 (1001-1050)	1001-1050	50	500	1385,00	2,77
8020387249	MTG 6,4 (1051-1100)	1051-1100	50	500	1385,00	2,77
8020386019	MTG 8 Baskılı	Baskılı / Printed	50	500	1435,00	2,87
8020386009	MTG 8 Baskısız	Boş / Empty	50	500	1185,00	2,37
8020386199	MTG 8 (0)	0	50	500	1435,00	2,87

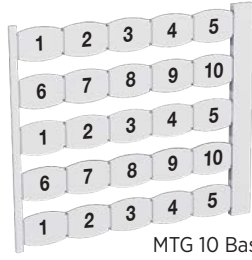

MTG 10 Baskılı



MTG 10 Baskısız

Ürün Kodu Product Code	Ürün Adı Product Name	Açıklama Description	Plaka Miktarı Plate Qty (Adet/Pcs.)	Amb. Mik. Pack. Qty (Plaka-Plates/Pcs.)	Plaka Fiyatı Plate Price (TL)	Adet Fiyatı Pcs. Price (TL/Adet)
8020386209	MTG 8 (1)	1	50	500	1435,00	2,87
8020386219	MTG 8 (2)	2	50	500	1435,00	2,87
8020386229	MTG 8 (3)	3	50	500	1435,00	2,87
8020386239	MTG 8 (4)	4	50	500	1435,00	2,87
8020386249	MTG 8 (5)	5	50	500	1435,00	2,87
8020386259	MTG 8 (6)	6	50	500	1435,00	2,87
8020386269	MTG 8 (7)	7	50	500	1435,00	2,87
8020386279	MTG 8 (8)	8	50	500	1435,00	2,87
8020386289	MTG 8 (9)	9	50	500	1435,00	2,87
8020386299	MTG 8 (10)	10	50	500	1435,00	2,87
8020386309	MTG 8 (0-9)	0-9	50	500	1435,00	2,87
8020386319	MTG 8 (1-10)	1-10	50	500	1435,00	2,87
8020386029	MTG 8 (1-50)	1-50	50	500	1435,00	2,87
8020386039	MTG 8 (51-100)	51-100	50	500	1435,00	2,87
8020386049	MTG 8 (101-150)	101-150	50	500	1435,00	2,87
8020386059	MTG 8 (151-200)	151-200	50	500	1435,00	2,87
8020386069	MTG 8 (201-250)	201-250	50	500	1435,00	2,87
8020386079	MTG 8 (251-300)	251-300	50	500	1435,00	2,87
8020386089	MTG 8 (301-350)	301-350	50	500	1435,00	2,87
8020386099	MTG 8 (351-400)	351-400	50	500	1435,00	2,87
8020386109	MTG 8 (401-450)	401-450	50	500	1435,00	2,87
8020386119	MTG 8 (451-500)	451-500	50	500	1435,00	2,87
8020386169	MTG 8 (701-750)	701-750	50	500	1435,00	2,87
8020386189	MTG 8 (801-850)	801-850	50	500	1435,00	2,87
8020386329	MTG 8 (+)	+	50	500	1435,00	2,87
8020386339	MTG 8 (-)	-	50	500	1435,00	2,87
8020386349	MTG 8 (PE)	PE	50	500	1435,00	2,87
8020386359	MTG 8 (L)	L	50	500	1435,00	2,87
8020386369	MTG 8 (N)	N	50	500	1435,00	2,87
8020386379	MTG 8 (L1, L2, L3)	L1, L2, L3	50	500	1435,00	2,87
8020386389	MTG 8 (L1)	L1	50	500	1435,00	2,87
8020386399	MTG 8 (L2)	L2	50	500	1435,00	2,87
8020386409	MTG 8 (L3)	L3	50	500	1435,00	2,87
8020385019	MTG 10 Baskılı	Baskılı / Printed	25	250	1530,00	6,12
8020385009	MTG 10 Baskısız	Boş / Empty	25	250	1252,50	5,01
8020385029	MTG 10 (1)	1	25	250	1530,00	6,12
8020385039	MTG 10 (2)	2	25	250	1530,00	6,12
8020385049	MTG 10 (3)	3	25	250	1530,00	6,12
8020385059	MTG 10 (4)	4	25	250	1530,00	6,12
8020385069	MTG 10 (5)	5	25	250	1530,00	6,12
8020385079	MTG 10 (6)	6	25	250	1530,00	6,12
8020385089	MTG 10 (7)	7	25	250	1530,00	6,12
8020385099	MTG 10 (8)	8	25	250	1530,00	6,12
8020385109	MTG 10 (9)	9	25	250	1530,00	6,12
8020385119	MTG 10 (10)	10	25	250	1530,00	6,12
8020385129	MTG 10 (RSTN)	RSTN	25	250	1530,00	6,12
8020385139	MTG 10 (L1)	L1	25	250	1530,00	6,12
8020385149	MTG 10 (L2)	L2	25	250	1530,00	6,12
8020385159	MTG 10 (L3)	L3	25	250	1530,00	6,12

Klemensler Terminals Blocks	Klemens Code List	Nihayet Plakası End Plate	Ayrırma Plakası Separation Plate	Ayrırma Dili Small Partitation Plate	Üst Köprü Cross Connections	Kayar Köprü
NTB 2,5	8000099208	8012396288 EPL NTB 2,5-10	PR TBL 2,5 - 10 8012396408	8012396528 - SPR 2,5-10	8013294523 - PCC 2,5/2 8013294533 - PCC 2,5/3 8013294503 - PCC 2,5/10	---
NTB 4	8000099308	8012396288 EPL NTB 2,5-10	PR TBL 2,5 - 10 8012396408	8012396528 - SPR 2,5-10	8013294623 - PCC 4/2 8013294633 - PCC 4/3 8013294603 - PCC 4/10	---
NTB 6	8000099408	8012396288 EPL NTB 2,5-10	PR TBL 2,5 - 10 8012396408	8012396528 - SPR 2,5-10	8013294723 - PCC 6/2 8013294733 - PCC 6/3 8013294703 - PCC 6/10	---
NTB 10	8000099508	8012396288 EPL NTB 2,5-10	PR TBL 2,5 - 10 8012396408	8012396528 - SPR 2,5-10	8013294823 - PCC 10/2 8013294833 - PCC 10/3	---
NTB 2,5 E	8001099304	8012396284 - EPL NTB 2,5-10 E	PR TBL 2,5 - 10 8012396408	8012396528 - SPR 2,5-10	---	---
NTB 4 E	8001099314	8012396284 - EPL NTB 2,5-10 E	PR TBL 2,5 - 10 8012396408	8012396528 - SPR 2,5-10	---	---
NTB 6 E	8001099324	8012396284 - EPL NTB 2,5-10 E	PR TBL 2,5 - 10 8012396408	8012396528 - SPR 2,5-10	---	---
NTB 10 E	8001099334	8012396284 - EPL NTB 2,5-10 E	PR TBL 2,5 - 10 8012396408	8012396528 - SPR 2,5-10	---	---
NTB 2,5 2P	8002099558	8012396388 - EPL NTB 2,5- 4 2P	PR TBL 2,5 - 10 8012396408	8012396528 - SPR 2,5-10	8013294523 - PCC 2,5/2 8013294533 - PCC 2,5/3 8013294503 - PCC 2,5/10	---
NTB 2,5 P + E	8002099568	8012396388 - EPL NTB 2,5- 4 2P	PR TBL 2,5 - 10 8012396408	8012396528 - SPR 2,5-10	8013294523 - PCC 2,5/2 8013294533 - PCC 2,5/3 8013294503 - PCC 2,5/10	---
NTB 4 2P	8002099658	8012396388 - EPL NTB 2,5- 4 2P	PR TBL 2,5 - 10 8012396408	8012396528 - SPR 2,5-10	8013294623 - PCC 4/2 8013294633 - PCC 4/3 8013294603 - PCC 4/10	---
NTB 4 P + E	8002099668	8012396388 - EPL NTB 2,5- 4 2P	PR TBL 2,5 - 10 8012396408	8012396528 - SPR 2,5-10	8013294623 - PCC 4/2 8013294633 - PCC 4/3 8013294603 - PCC 4/10	---
NTB 2,5 2P E	8002099558	8012396384 - EPL NTB 2,5-4 2P E	PR TBL 2,5 - 10 8012396408	8012396528 - SPR 2,5-10	---	---
NTB 4 2P E	8002099556	8012396384 - EPL NTB 2,5-4 2P E	PR TBL 2,5 - 10 8012396408	8012396528 - SPR 2,5-10	---	---
TBL 2,5	8000099008	8012396118-EPL TBL 2,5-10	PR TBL 2,5 - 10 8012396408	8012396528 - SPR 2,5-10	8013095023 - SCC 2,5/2 8013095033 - SCC 2,5/3 8013095003 - SCC 2,5/10	---
TBL 4	8000099028	8012396118-EPL TBL 2,5-10	PR TBL 2,5 - 10 8012396408	8012396528 - SPR 2,5-10	SCC 4/2 8013095123 SCC 4/3 8013095133 SCC 4/10 8013095103	---
TBL 6	8000099038	8012396118-EPL TBL 2,5-10	PR TBL 2,5 - 10 8012396408	8012396528 - SPR 2,5-10	8013095223 - SCC 6/2 8013095233 - SCC 6/3 8013095203 - SCC 6/10	---
TBL 6	8000099038	8012396118-EPL TBL 2,5-10	PR TBL 2,5 - 10 8012396408	8012396528 - SPR 2,5-10	8013095223 - SCC 6/2 8013095233 - SCC 6/3 8013095203 - SCC 6/10	---
TBL 10	8000099048	8012396118-EPL TBL 2,5-10	PR TBL 2,5 - 10 8012396408	8012396528 - SPR 2,5-10	8013095323 - SCC 10/2 8013095333 - SCC 10/3 8013095303 - SCC 10/10	---
TBL 16	8000099058	---	8012396568 - GPR	---	8013095423 - SCC 16/2 8013095433 - SCC 16/3 8013095403 - SCC 16/10	---
TBL 25	8000099068	---	8012396568 - GPR	---	8013095523 - SCC 25/2 8013095533 - SCC 25/3 8013095503 - SCC 25/10	---
TBL 35	8000099078	---	8012396568 - GPR	---	8013095623 - SCC 35/2 8013095633 - SCC 35/3 8013095603 - SCC 35/10	---
TBL 50	8000099088	---	8012396568 - GPR	---	SCC 50/2 8013095723 SCC 50 /3 8013095733	---
TBL 70	8000099098	---	8012396568 - GPR	---	SCC 70/2 8013095823 SCC 70 /3 8013095833	---

Klemensler Terminals Blocks	Klemens Code List	Nihayet Plakası End Plate	Ayırma Plakası Seperation Plate	Ayırma Dili Smal Partitation Plate	Üst Köprü Cross Connections	Kayar Köprü
TBL 95	8000099108	---	---	---	8013095923 - SCC 95/2 8013095933 - SCC 95/3	---
TBL 150	8000099116	---	---	---	SCC 150/2 8013094023	---
NTT 2,5 E	8001099214	8012396118-EPL TBL 2.5-10	---	---	---	---
NTT 4 E	8001099224	8012396118-EPL TBL 2.5-10	---	---	---	---
NTT 6 E	8001099234	8012396118-EPL TBL 2.5-10	---	---	---	---
NTT 10 E	8001099244	8012396118-EPL TBL 2.5-10	---	---	---	---
TBL 16 E	8001099194	---	---	---	---	---
TBL 35 E	8001099204	---	---	---	---	---
TBL 2,5-4 2P	8002099438	8012396208 - EPL TBL 2,5-4 2P	PR TBL 4 2P 8012396508	SPR TBL 4 2P 8012396558	8013095023 - SCC 2,5/2 8013095033 - SCC 2,5/3 8013095003 - SCC 2,5/10	---
TBL 4 2P	8002099258	8012396218-EPL1 TBL 4 2P 8012396228-EPL2 TBL 4 2P 8012396238 - EPL3 TBL 4 2P	8012396568 - GPR	---	8013094103 - SCC 4/10 TBL 4 2P 8013094123 - SCC 4/2 TBL 4 2P 8013094133 - SCC 4/3 TBL 4 2P	---
TBL 2,5 - 2P+E	8002099158	8012396158 - EPL TBL 2,5 2P+E	8012396568 - GPR	---	8013095023 - SCC 2,5/2 8013095033 - SCC 2,5/3 8013095003 - SCC 2,5/10	---
TBL 2,5-4 2PK	8002099448	8012396208 - EPL TBL 2,5-4 2P	8012396568 - GPR	---	8013094103 - SCC 4/10 TBL 4 2P 8013094123 - SCC 4/2 TBL 4 2P 8013094133 - SCC 4/3 TBL 4 2P	---
TBL 2,5-4 2PL (24-48VAC/DC)	8002099458	8012396208 - EPL TBL 2,5-4 2P	8012396568 - GPR	---	---	---
TBL 2,5-4 2PL (110-220VAC/DC)	8002099468	8012396208 - EPL TBL 2,5-4 2P	8012396568 - GPR	---	---	---
TBL 4 2P X1, X2, X3, X4, X5, X6, X7, X8	8002099268 8002099278 8002099288 8002099298 8002099318 8002099305 8002099328 8002099338 8002099348	8012396218 - EPL1 TBL 4 2P 8012396228 - EPL2 TBL 4 2P 8012396238 - EPL3 TBL 4 2P	---	8012396558 - SPR TBL 4 2P	---	---
TBL 4 2PL (24-48VAC/DC)	8002099368	8012396218 - EPL1 TBL 4 2P 8012396228 - EPL2 TBL 4 2P 8012396238 - EPL3 TBL 4 2P	---	8012396558 - SPR TBL 4 2P	---	---
TBL 4 2PL (110-220VAC/DC)	8002099378	8012396218 - EPL1 TBL 4 2P 8012396228 - EPL2 TBL 4 2P 8012396238 - EPL3 TBL 4 2P	---	8012396558 - SPR TBL 4 2P	---	---
TBL 4 2PK	8002099428	8012396218 - EPL1 TBL 4 2P 8012396228 - EPL2 TBL 4 2P 8012396238 - EPL3 TBL 4 2P	---	8012396558 - SPR TBL 4 2P	---	---
TBL 4 3P	8002099478	---	8012396568 - GPR	---	8013094103 - SCC 4/10 TBL 4 2P 8013094123 - SCC 4/2 TBL 4 2P 8013094133 - SCC 4/3 TBL 4 2P	---
TBL 2,5 S	8003099528	---	---	---	---	---
NTB 4 P+F Gri	8003098008	8012396588 - EPL NTB 4 P+F Gri	8012396568 - GPR	---	8013294723 - PCC 6/2 8013294733 - PCC 6/3 8013294703 - PCC 6/10	---

Tarak Köprü Comb Connector	Test Fişi Test Socket	Durdurucu Stopper	Şerit Etiket Strip Label	Etiket Marking Tags	Ray DIN Rail	Kapak Cover
---	---	8010097308 - SS 1 8010097318 - SS 2 8010197328 - PS 1 8010197420 - PS 2	---	8020385009 - MTG 10 Boş	8015393407 - DR 35-7,5 S 2M 8015393427 - DR 35-15 S 2M	---
---	---	8010097308 - SS 1 8010097318 - SS 2 8010197328 - PS 1 8010197420 - PS 2	---	8020385009 - MTG 10 Boş	8015393407 - DR 35-7,5 S 2M 8015393427 - DR 35-15 S 2M	---
---	---	8010097308 - SS 1 8010097318 - SS 2 8010197328 - PS 1 8010197420 - PS 2	---	MTG 6 8020388009	8015393407 - DR 35-7,5 S 2M 8015393427 - DR 35-15 S 2M	---
---	---	8010097308 - SS 1 8010097318 - SS 2 8010197328 - PS 1 8010197420 - PS 2	---	MTG 6,4 8020387009	8015393407 - DR 35-7,5 S 2M 8015393427 - DR 35-15 S 2M	---
---	---	8010097308 - SS 1 8010097318 - SS 2 8010197328 - PS 1 8010197420 - PS 2	---	MTG 8 8020386009	8015393407 - DR 35-7,5 S 2M 8015393427 - DR 35-15 S 2M	---
---	---	8010097308 - SS 1 8010097318 - SS 2 8010197328 - PS 1 8010197420 - PS 2	---	MTG 10 8020385009	8015393407 - DR 35-7,5 S 2M 8015393427 - DR 35-15 S 2M	---
---	---	8010097308 - SS 1 8010097318 - SS 2 8010197328 - PS 1 8010197420 - PS 2	---	MTG 10 8020385009	8015393407 - DR 35-7,5 S 2M 8015393427 - DR 35-15 S 2M	---
---	---	8010097308 - SS 1 8010097318 - SS 2 8010197328 - PS 1 8010197420 - PS 2	---	MTG 10 8020385009	8015393407 - DR 35-7,5 S 2M 8015393427 - DR 35-15 S 2M	---
---	8014393227 - TST 1	8010097308 - SS 1 8010097318 - SS 2 8010197328 - PS 1 8010197420 - PS 2	---	8020388009 - MTG 6 Boş	8015393407 - DR 35-7,5 S 2M 8015393427 - DR 35-15 S 2M	---
---	8014393227 - TST 1	8010097308 - SS 1 8010097318 - SS 2 8010197328 - PS 1 8010197420 - PS 2	---	8020387009 - MTG 6,4 Boş	8015393407 - DR 35-7,5 S 2M 8015393427 - DR 35-15 S 2M	---
---	---	8010097308 - SS 1 8010097318 - SS 2 8010197328 - PS 1 8010197420 - PS 2	---	8020389009 - MTG 5 Boş	8015393407 - DR 35-7,5 S 2M 8015393427 - DR 35-15 S 2M	---
---	8014393227 - TST 1	8010097308 - SS 1 8010097318 - SS 2 8010197328 - PS 1 8010197420 - PS 2	---	8020388009 - MTG 6 Boş	8015393407 - DR 35-7,5 S 2M 8015393427 - DR 35-15 S 2M	---
---	8014393227 - TST 1	8010097308 - SS 1 8010097318 - SS 2 8010197328 - PS 1 8010197420 - PS 2	---	8020388009 - MTG 6 Boş	8015393407 - DR 35-7,5 S 2M 8015393427 - DR 35-15 S 2M	---
---	8014393227 - TST 1	8010097308 - SS 1 8010097318 - SS 2 8010197328 - PS 1 8010197420 - PS 2	---	8020388009 - MTG 6 Boş	8015393407 - DR 35-7,5 S 2M 8015393427 - DR 35-15 S 2M	---
---	8014393227 - TST 1	8010097308 - SS 1 8010097318 - SS 2 8010197328 - PS 1 8010197420 - PS 2	---	8020387009 - MTG 6,4 Boş	8015393407 - DR 35-7,5 S 2M 8015393427 - DR 35-15 S 2M	---
---	8014393227 - TST 1	8010097308 - SS 1 8010097318 - SS 2 8010197328 - PS 1 8010197420 - PS 2	---	8020387009 - MTG 6,4 Boş	8015393407 - DR 35-7,5 S 2M 8015393427 - DR 35-15 S 2M	---
---	8014393227 - TST 1	8010097308 - SS 1 8010097318 - SS 2 8010197328 - PS 1 8010197420 - PS 2	---	8020387009 - MTG 6,4 Boş	8015393407 - DR 35-7,5 S 2M 8015393427 - DR 35-15 S 2M	---
---	8014393227 - TST 1	8010097308 - SS 1 8010097318 - SS 2 8010197328 - PS 1 8010197420 - PS 2	---	8020387009 - MTG 6,4 Boş	8015393407 - DR 35-7,5 S 2M 8015393427 - DR 35-15 S 2M	---
---	---	8010097308 - SS 1 8010097318 - SS 2 8010197328 - PS 1 8010197420 - PS 2	---	8020388009 - MTG 6 Boş	8015393407 - DR 35-7,5 S 2M 8015393427 - DR 35-15 S 2M	---
---	---	8010097308 - SS 1 8010097318 - SS 2 8010197328 - PS 1 8010197420 - PS 2	8020384009 - TBLS 22X20	8020386009 - MTG 8 Boş	8015393407 - DR 35-7,5 S 2M 8015393427 - DR 35-15 S 2M	---

Klemensler Terminals Blocks	Klemens Code List	Nihayet Plakası End Plate	Ayrırma Plakası Seperation Plate	Ayrırma Dili Smal Partitation Plate	Üst Köprü Cross Connections	Kayar Köprü
FDT 4 L (24-48 VAC/DC)	8003099498	---	---	---	---	---
FDT 4 L (110-220 VAC/DC)	8003099508	---	---	---	---	---
FDT 4 L (24-48 VAC/DC)	8003099496	---	---	---	---	---
FDT 4 L (110-220 VAC/DC)	8003099506	---	---	---	---	---
FDT 4 L (110-220 VAC)	8003099518	---	---	---	---	---
TDT-C 6	8004099808	---	---	---	---	8013394923 -SLC2 8013394933 -SLC3 8013394943 -SLC4
TDT-V 6	8004099818	---	---	---	---	8013394923 -SLC2 8013394933 -SLC3 8013394943 -SLC4
TDS-C 6	8004099828	8012396018 - EPL TDS	---	---	---	8013394923 -SLC2 8013394933 -SLC3 8013394943 -SLC4
TDV-C 6	8004099838	8012396028 - EPL TDV	---	---	---	---
TDS-V 6	8004099848	8012396018 - EPL TDS	---	---	---	8013394923 -SLC2 8013394933 -SLC3 8013394943 -SLC4
TDV-6	8004099878	---	---	---	8013295723 - PCC 6/2 - T 8013295733 - PCC 6/3 - T 8013295703 - PCC 6/10 - T	---
TBB 70	8000099128	---	---	---	---	---
TBB 95	8000099138	---	---	---	---	---
TBB 150	8000099148	---	---	---	---	---
TBB 240	8000099158	---	---	---	---	---

Tarak Köprü Comb Connector	Test Fişi Test Socket	Durdurucu Stopper	Şerit Etiket Strip Label	Etiket Marking Tags	Ray DIN Rail	Kapak Cover
8013394823 - TCC 6/2 8013394833 - TCC 6/3 8013394803 TCC 6/10	---	8010097308 - SS 1 8010097318 - SS 2 8010197328 - PS 1 8010197420 - PS 2	---	8020386009 - MTG 8 Boş	8015393407 - DR 35-7,5 S 2M 8015393427 - DR 35-15 S 2M	---
8013394823 - TCC 6/2 8013394833 - TCC 6/3 8013394803 TCC 6/10	---	8010097308 - SS 1 8010097318 - SS 2 8010197328 - PS 1 8010197420 - PS 2	---	8020386009 - MTG 8 Boş	8015393407 - DR 35-7,5 S 2M 8015393427 - DR 35-15 S 2M	---
8013394823 - TCC 6/2 8013394833 - TCC 6/3 8013394803 TCC 6/10	---	8010097308 - SS 1 8010097318 - SS 2 8010197328 - PS 1 8010197420 - PS 2	---	8020386009 - MTG 8 Boş	8015393407 - DR 35-7,5 S 2M 8015393427 - DR 35-15 S 2M	---
8013394823 - TCC 6/2 8013394833 - TCC 6/3 8013394803 TCC 6/10	---	8010097308 - SS 1 8010097318 - SS 2 8010197328 - PS 1 8010197420 - PS 2	---	8020386009 - MTG 8 Boş	8015393407 - DR 35-7,5 S 2M 8015393427 - DR 35-15 S 2M	---
8013394823 - TCC 6/2 8013394833 - TCC 6/3 8013394803 TCC 6/10	---	8010097308 - SS 1 8010097318 - SS 2 8010197328 - PS 1 8010197420 - PS 2	---	8020386009 - MTG 8 Boş	8015393407 - DR 35-7,5 S 2M 8015393427 - DR 35-15 S 2M	---
8013394823 - TCC 6/2 8013394833 - TCC 6/3 8013394803 TCC 6/10	8014393108 - TST-11	8010097308 - SS 1 8010097318 - SS 2 8010197328 - PS 1 8010197420 - PS 2	---	8020386009 - MTG 8 Boş	8015393407 - DR 35-7,5 S 2M 8015393427 - DR 35-15 S 2M	---
8013394823 - TCC 6/2 8013394833 - TCC 6/3 8013394803 TCC 6/10	8014393108 - TST-11	8010097308 - SS 1 8010097318 - SS 2 8010197328 - PS 1 8010197420 - PS 2	---	8020386009 - MTG 8 Boş	8015393407 - DR 35-7,5 S 2M 8015393427 - DR 35-15 S 2M	---
8013394823 - TCC 6/2 8013394833 - TCC 6/3 8013394803 TCC 6/10	8014393108 - TST-11	8010097308 - SS 1 8010097318 - SS 2 8010197328 - PS 1 8010197420 - PS 2	---	8020386009 - MTG 8 Boş	8015393407 - DR 35-7,5 S 2M 8015393427 - DR 35-15 S 2M	---
8013394823 - TCC 6/2 8013394833 - TCC 6/3 8013394803 TCC 6/10	---	8010097308 - SS 1 8010097318 - SS 2 8010197328 - PS 1 8010197420 - PS 2	---	8020386009 - MTG 8 Boş	8015393407 - DR 35-7,5 S 2M 8015393427 - DR 35-15 S 2M	---
8013394823 - TCC 6/2 8013394833 - TCC 6/3 8013394803 TCC 6/10	8014393108 - TST-11	8010097308 - SS 1 8010097318 - SS 2 8010197328 - PS 1 8010197420 - PS 2	---	8020386009 - MTG 8 Boş	8015393407 - DR 35-7,5 S 2M 8015393427 - DR 35-15 S 2M	---
8013394823 - TCC 6/2 8013394833 - TCC 6/3 8013394803 TCC 6/10	8014394250 - TFT 4	8010097308 - SS 1 8010097318 - SS 2 8010197328 - PS 1 8010197420 - PS 2	8020384009 - TBSL 22X20	8020386009 - MTG 8 Boş	8015393407 - DR 35-7,5 S 2M 8015393427 - DR 35-15 S 2M	
---	---	8010097308 - SS 1 8010097318 - SS 2 8010197328 - PS 1 8010197420 - PS 2	---	8020389009 - MTG 5 Boş	8015393407 - DR 35-7,5 S 2M 8015393427 - DR 35-15 S 2M	C-TBB 70-95-150
---	---	8010097308 - SS 1 8010097318 - SS 2 8010197328 - PS 1 8010197420 - PS 2	---	8020389009 - MTG 5 Boş	8015393407 - DR 35-7,5 S 2M 8015393427 - DR 35-15 S 2M	C-TBB 70-95-150
---	---	8010097308 - SS 1 8010097318 - SS 2 8010197328 - PS 1 8010197420 - PS 2	---	8020389009 - MTG 5 Boş	8015393407 - DR 35-7,5 S 2M 8015393427 - DR 35-15 S 2M	C-TBB 70-95-150
---	---	8010097308 - SS 1 8010097318 - SS 2 8010197328 - PS 1 8010197420 - PS 2	---	8020389009 - MTG 5 Boş	8015393407 - DR 35-7,5 S 2M 8015393427 - DR 35-15 S 2M	C-TBB 240

Klemensler Terminals Blocks	Klemens Code List	Nihayet Plakası End Plate	Ayrırma Plakası Seperation Plate	Ayrırma Dili Smal Partitation Plate	Üst Köprü Cross Connections	Kayar Köprü
PFT 2,5	8000298008	---	---	---	8013294523 - PCC 2,5/2 8013294533 - PCC 2,5/3 8013294503 - PCC 2,5/10	---
PFT 4	8000298018	---	---	---	PCC 4/2 8013294623 PCC 4/3 8013294633 PCC 4/10 8013294603	---
PFT 6	8000298028	---	---	---	PCC 6/2 8013294723 PCC 6/3 8013294733 PCC 6/10 8013294703	---
PFT 10	8000298038	---	---	---	PCC 10/2 8013294823 PCC 10/3 8013294833	---
PFT 16	8000298043	---	---	---	8013294923 - PCC 16/2	---
PFT 2,5 E	8001298064	---	---	---	---	---
PFT 4 E	8001298074	---	---	---	---	---
PFT 6 E	8001298084	---	---	---	---	---
PFT 10 E	8001298104	---	---	---	---	---
PFT 16 E	8001298114	---	---	---	---	---
PFT 2,5 1X2	8000298068	---	---	---	8013294523 - PCC 2,5/2 8013294533 - PCC 2,5/3 8013294503 - PCC 2,5/10	---
PFT 2,5 1X2	8000298060	---	---	---	8013294523 - PCC 2,5/2 8013294533 - PCC 2,5/3 8013294503 - PCC 2,5/10	---
PFT 2,5 2X2	8000298078	---	---	---	8013294523 - PCC 2,5/2 8013294533 - PCC 2,5/3 8013294503 - PCC 2,5/10	---
PFT 4 1X2	8000298168	---	---	---	8013294623 - PCC 4/2 8013294633 - PCC 4/3 8013294603 - PCC 4/10	---
PFT 4 2X2	8000298178	---	---	---	8013294623 - PCC 4/2 8013294633 - PCC 4/3 8013294603 - PCC 4/10	---
PFT 4 1X2 E	8001298165	---	---	---	---	---
PFT 4 2X2 E	8001298166	---	---	---	---	---
PFT 2,5 2P	8002298098	---	---	---	8013294523 - PCC 2,5/2 8013294533 - PCC 2,5/3 8013294503 - PCC 2,5/10	---
PFT 2,5 3P	8002298198	---	---	---	8013294523 - PCC 2,5/2 8013294533 - PCC 2,5/3 8013294503 - PCC 2,5/10	---
PFT 2,5 2P+E	8002298108	---	---	---	8013294523 - PCC 2,5/2 8013294533 - PCC 2,5/3 8013294503 - PCC 2,5/10	---
PFT 4 2P	8002298118	---	---	---	PCC 4/2 8013294623 PCC 4/3 8013294633 PCC 4/10 8013294603	---
PFT 2,5 S	8003200508	---	---	---	8013294523 - PCC 2,5/2 8013294533 - PCC 2,5/3 8013294503 - PCC 2,5/10	---
PFT 2,5 S 1x2	8003200518	---	---	---	8013294523 - PCC 2,5/2 8013294533 - PCC 2,5/3 8013294503 - PCC 2,5/10	---
PFT 2,5 S 2x2	8003200528	---	---	---	8013294523 - PCC 2,5/2 8013294533 - PCC 2,5/3 8013294503 - PCC 2,5/10	---

Elektrolitik beyaz krom kaplanmış galvaniz çelik malzeme
Electrolytic white chromated & galvanized steel material
EN 50022 EN 50035 IEC 60715

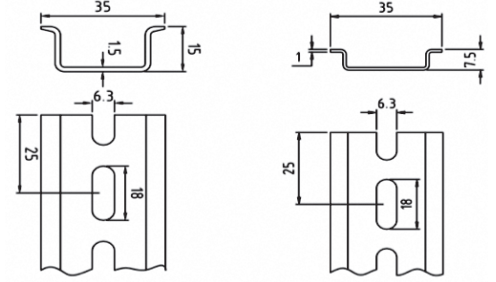

Montaj Rayları

Mounting Rails

Ürün Kodu Product Code	Ürün Adı Product Name	Ölçüler / Dimensions (mm)		Açıklama Explanation	Birim Uzunluk Unit Length (m)	Ambalaj Miktarı Package Qty (metre/meter)	Birim Fiyatı Unit Price (TL/mt.)
		W	H				
8015393407	DR 35-7,5 S 2M	35	7,5	Delikli Din Normu Ray / Slotted Din Rail	2	40	293,72
8015393427	DR 35-15 S 2M	35	15	Delikli Din Normu Ray / Slotted Din Rail	2	20	594,88

Eko Seri Montaj Rayları

Economical Range Mounting Rails

Ürün Kodu Product Code	Ürün Adı Product Name	Ölçüler / Dimensions (mm)		Açıklama Explanation	Birim Uzunluk Unit Length (m)	Ambalaj Miktarı Package Qty (metre/meter)	Birim Fiyatı Unit Price (TL/mt.)
		W	H				
8015393447	DR 35-7,5 E 2M	35	7,5	Delikli Din Normu Ray / Slotted Din Rail	2	50	174,92

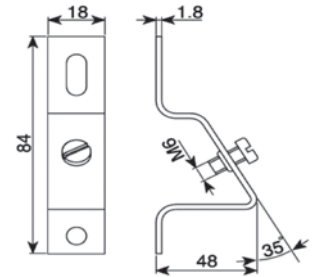

Ray Taşıyıcılar ve Kapakları

Rail Supports and Covers

Ürün Kodu Product Code	Ürün Adı Product Name	Açıklama Explanation	Delik Çapı Dia. Hole	Ambalaj Miktarı Package Qty (Adet/pcs.)	Birim Fiyatı Unit Price (TL/Adet)
8015393507	ART - M6	35° Açılı Ray Taşıyıcı / 35° Angeled Rail Support	M6	10	46,48
8015393537	C-DR 7,5	Ray Kenar Kapağı / Rail Cover	--	200	0,82
8015393547	C-DR 15	Ray Kenar Kapağı / Rail Cover	--	100	1,64



WDC 125

Kanal Kesme Makası

Wiring Duct Cutter

Ürün Kodu Product Code	Ürün Adı Product Name	Açıklama Explanation	Ambalaj Miktarı Package Qty (Adet/pcs.)	Birim Fiyatı Unit Price (TL/Adet)
8019391300	WDC 125	125 mm genişliğe kadar kablo kanalları için Düz kesim tezgah üstü makas. Flat-cut Table-top type cutter up to 120 mm duct width	1	Sorunuz



DRC 2W8R



DRC 1W

Ray Kesme Makasları

Din Rail Cutters

Ürün Kodu Product Code	Ürün Adı Product Name	Açıklama Explanation	Ambalaj Miktarı Package Qty (Adet/pcs.)	Birim Fiyatı Unit Price (TL/Adet)
8015393557	DRC 1W	35x7.5 raya uygun, 1.5 mm kalınlığa kadar kesim, 1 gözlü tezgah üstü makas. 1 way table-top type cutter for 35x7.5 Din Rail, up to 1.5 mm thickness	1	Sorunuz
8015393567	DRC 2W8R	35x7.5, 35x15 raya ve 8 mm Tij kesimine uygun, 3 gözlü tezgah üstü makas. 3 way table-top type cutter for 35x7.5, 35x15 Din Rails and 8 mm Rod	1	Sorunuz

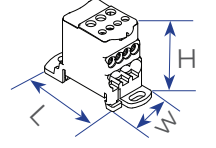

Dağıtım Blokları SDB Serisi

Distribution Blocks SDB Series

Ürün Kodu Product Code	Ürün Adı Product Name	Açıklama Explanation	Ebatlar Dimension (mm ²)	Voltaj Voltage	Amper Current	Amb. Mik. Pack. Qty (Adet/Pcs.)	Birim Fiyatı Unit Price (TL/Adet)
8037000100	SDB 80 A	Dağıtım Blokları / Distribution Blocks	66x27x46	1000 V	80 A	1	362,00
8037000110	SDB 125 A	Dağıtım Blokları / Distribution Blocks	77x29x46	1000 V	125 A	1	732,55
8037000120	SDB 160 A	Dağıtım Blokları / Distribution Blocks	77x29x46	1000 V	160 A	1	753,48
8037000130	SDB 250A	Dağıtım Blokları / Distribution Blocks	96x46x50	1000 V	250 A	1	2.129,40
8037000140	SDB 400 A	Dağıtım Blokları / Distribution Blocks	96x46x50	1000 V	400 A	1	2.302,30
8037000150	SDB 500 A	Dağıtım Blokları / Distribution Blocks	96x46x50	1000 V	500 A	1	2.616,25

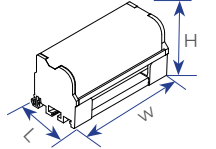

Dağıtım Blokları TDB Serisi

Distribution Blocks TDB Series

Ürün Kodu Product Code	Ürün Adı Product Name	Açıklama Explanation	Ebatlar Dimension (mm ²)	Voltaj Voltage	Amper Current	Amb. Mik. Pack. Qty (Adet/Pcs.)	Birim Fiyatı Unit Price (TL/Adet)
8037000220	TDB 2 x7-100A	Dağıtım Blokları / Distribution Blocks	50x64x50	1000 V	100 A	1	418,60
8037000230	TDB 2 x 7 - 125 A	Dağıtım Blokları / Distribution Blocks	50x64x50	500 V	125 A	1	502,32
8037000210	TDB 2 x 8-80A	Dağıtım Blokları / Distribution Blocks	50x64x50	500 V	80 A	1	418,60
8037000221	TDB 2 x 11-100A	Dağıtım Blokları / Distribution Blocks	50x100x50	500 V	100 A	1	795,34
8037000231	TDB 2 x 11-125A	Dağıtım Blokları / Distribution Blocks	50x100x50	500 V	125 A	1	606,97
8037000232	TDB 2 x 15-125A	Dağıtım Blokları / Distribution Blocks	50x130x50	500 V	125 A	1	784,88
8037000211	TDB 2 x 18-80A	Dağıtım Blokları / Distribution Blocks	50x130x50	500 V	80 A	1	1.046,50

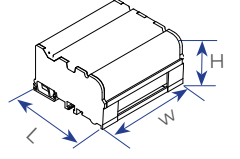

Dağıtım Blokları TDB Serisi

Distribution Blocks TDB Series

Ürün Kodu Product Code	Ürün Adı Product Name	Açıklama Explanation	Ebatlar Dimension (mm ²)	Voltaj Voltage	Amper Current	Amb. Mik. Pack. Qty (Adet/Pcs.)	Birim Fiyatı Unit Price (TL/Adet)
8037000320	FDB 4 x 7-100A	Dağıtım Blokları / Distribution Blocks	90x64x50	1000 V	100 A	1	837,20
8037000330	FDB 4 x 7-125A	Dağıtım Blokları / Distribution Blocks	90x64x50	500 V	125 A	1	941,85
8037000310	FDB 4 x 8-80A	Dağıtım Blokları / Distribution Blocks	90x64x50	500 V	80 A	1	837,20
8037000321	FDB 4 x 11-100A	Dağıtım Blokları / Distribution Blocks	90x100x50	500 V	100 A	1	1.193,01
8037000331	FDB 4 x 11-125A	Dağıtım Blokları / Distribution Blocks	90x100x50	500 V	125 A	1	1.213,94
8037000332	FDB 4 x 15-125A	Dağıtım Blokları / Distribution Blocks	90x130x50	500 V	125 A	1	1.569,75
8037000312	FDB 4 x 18-80A	Dağıtım Blokları / Distribution Blocks	90x130x50	500 V	80 A	1	1.569,75

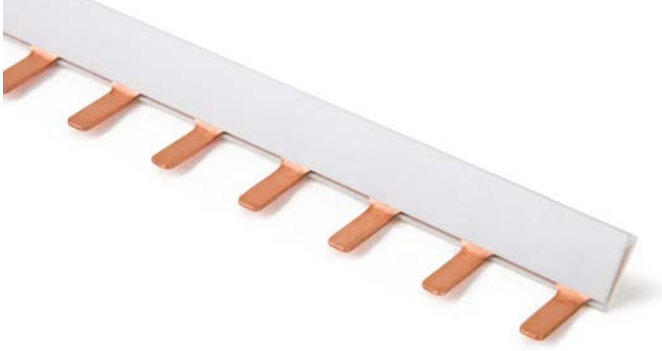

Monofaze W Otomat Baraları

Singlephase MCB Busbars

Ürün Kodu Product Code	Ürün Adı Product Name	Akım Current (A)	Bara Kalınlığı Busbar Thickness (mm)	Uzunluk Length (cm.)	Modül Sayısı Module Number	Ambalaj Mik. Pack. Qty. (TL/Ad.)	Birim Fiyatı Unit Price (TL/Ad.)
8034110010	MJAB80-1x53	80	1	53	30	50	476,91
8034110020	MJAB80-1x106	80	1	106	60	50	953,81
8034110030	MJAB100-1,5x53	100	1.5	53	30	50	663,52
8034110040	MJAB100-1,5x106	100	1.5	106	60	50	1.327,04

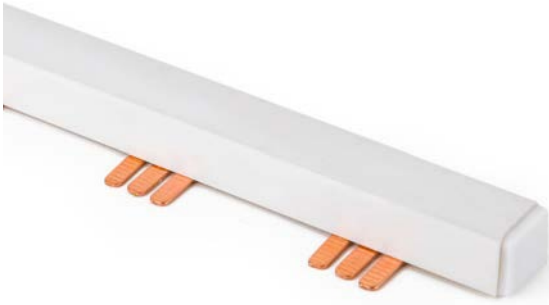

Trifaze W Otomat Baraları

Threephases MCB Busbars

Ürün Kodu Product Code	Ürün Adı Product Name	Akım Current (A)	Bara Kalınlığı Busbar Thickness (mm)	Uzunluk Length (cm.)	Modül Sayısı Module Number	Ambalaj Mik. Pack. Qty. (TL/Ad.)	Birim Fiyatı Unit Price (TL/Ad.)
8034330010	TJAB63- 1x53	63	1	53	10	25	1.140,43
8034330020	TJAB63- 1x106	63	1	106	20	25	2.280,85
8034330030	TJAB80- 1x53	80	1	53	10	25	1.244,10
8034330040	TJAB80- 1x106	80	1	106	20	25	2.488,20
8034330050	TJAB100-1,5x53	100	1.5	53	10	25	1.866,15
8034330060	TJAB100-1,5x106	100	1.5	106	20	25	3.732,30

W Otomat Bara Kapakları

MCB Busbar Side Covers

Ürün Kodu Product Code	Ürün Adı Product Name	Ambalaj Mik. Pack. Qty. (TL/Ad.)	Birim Fiyatı Unit Price (TL/Ad.)
8034110009	Monofaze otomat barası kapagi / Singlephase mcb busbar side covers	500	18,66
8034330009	Trifaze otomat barası kapagi / Threephases mcb busbar side covers	500	18,66

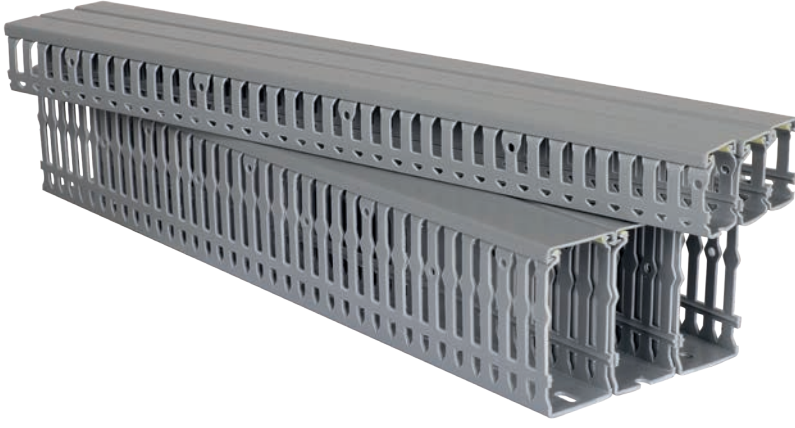

Kendini söndürebilen sert PVC malzeme
Self-extinguishing rigid PVC material
EN 50085-1+A
EN 50085-2-3
IEC 60695-2-11



Delikli Kablo Kanalları

Slotted Wiring Ducts

Ürün Kodu Product Code	Ürün Adı Product Name	Ölçüler / Dimensions (mm)		Renk Color	Ambalaj Miktarı Package Qty (metre/meter)	Birim Fiyatı Unit Price (TL/mt.)
		W	H			
8019391008	SWD 25X40 Pano Tipi Kablo Kanalı	25	40	Gri / Grey	60	185,90
8019391018	SWD 25X60 Pano Tipi Kablo Kanalı	25	60	Gri / Grey	40	250,97
8019391318	SWD 25X80 Pano Tipi Kablo Kanalı	25	80	Gri / Grey	20	347,63
8019391028	SWD 40X40 Pano Tipi Kablo Kanalı	40	40	Gri / Grey	40	254,68
8019391038	SWD 40X60 Pano Tipi Kablo Kanalı	40	60	Gri / Grey	36	301,16
8019391048	SWD 40X80 Pano Tipi Kablo Kanalı	40	80	Gri / Grey	28	382,95
8019391058	SWD 60X40 Pano Tipi Kablo Kanalı	60	40	Gri / Grey	32	293,72
8019391068	SWD 60X60 Pano Tipi Kablo Kanalı	60	60	Gri / Grey	24	399,69
8019391078	SWD 60X80 Pano Tipi Kablo Kanalı	60	80	Gri / Grey	16	490,78
8019391088	SWD 80X60 Pano Tipi Kablo Kanalı	80	60	Gri / Grey	20	446,16
8019391098	SWD 80X80 Pano Tipi Kablo Kanalı	80	80	Gri / Grey	16	546,55
8019391108	SWD 80X100 Pano Tipi Kablo Kanalı	80	100	Gri / Grey	8	736,16
8019391118	SWD 100X60 Pano Tipi Kablo Kanalı	100	60	Gri / Grey	12	658,09
8019391128	SWD 100X80 Pano Tipi Kablo Kanalı	100	80	Gri / Grey	8	736,16
8019391138	SWD 100X100 Pano Tipi Kablo Kanalı	100	100	Gri / Grey	8	847,70

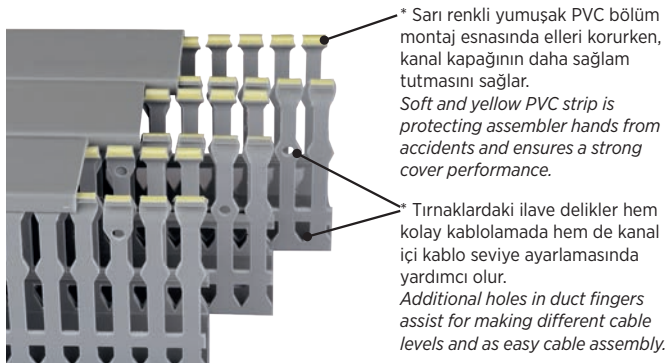

Kablo Kanal Kapakları

Wiring Duct Covers

Ürün Kodu Product Code	Ürün Adı Product Name	En Width (mm.)	Boy Length (m.)	Renk Color	Ambalaj Miktarı Package Qty (metre/meter)	Birim Fiyatı Unit Price (TL/mt.)
8019391208	SWC 25 Kapak	20	2	Gri / Grey	40	61,35
8019391218	SWC 40 Kapak	40	2	Gri / Grey	40	93,89
8019391228	SWC 60 Kapak	60	2	Gri / Grey	40	130,13
8019391238	SWC 80 Kapak	80	2	Gri / Grey	40	184,04
8019391248	SWC 100 Kapak	100	2	Gri / Grey	40	245,39

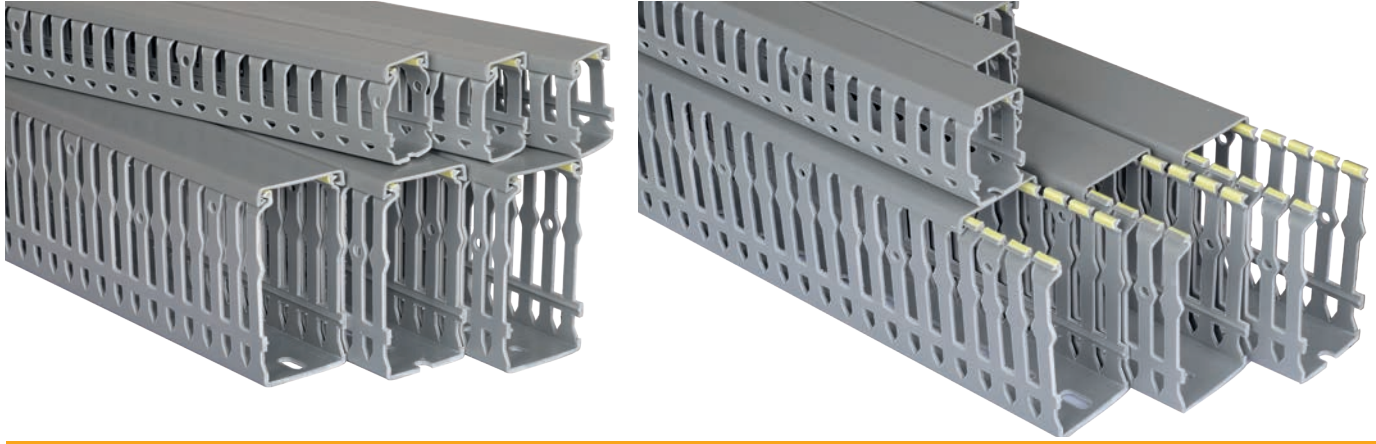

Teknik Bilgiler

Technical Information

Ürün Kodu Product Code	Ürün Adı Product Name	Ölçüler / Dimensions (mm)						Ölçülmüş Toplam Kesit Measured Total Cross Sec. (mm ²)	İletken Dolum Kapasitesi (%60 oran için) Wire Filling Capacity (for 60% ratio)		
		W	H	E	F	G	Ø		2,5 mm ²	1,5 mm ²	1,0 mm ²
8019391008	SWD 25X40	25	40	6,5	6	12,8	4,5	820	35	51	78
8019391018	SWD 25X60	25	60	6,5	6	15,7	4,5	1.190	57	83	112
8019391028	SWD 40X40	40	40	6,5	6	12,8	4,5	1.360	65	94	129
8019391038	SWD 40X60	40	60	6,5	6	15,7	4,5	2.040	98	141	192
8019391048	SWD 40X80	40	80	6,5	6	19,8	4,5	2.700	130	187	255
8019391058	SWD 60X40	60	40	6,5	6	12,8	4,5	1.970	95	134	188
8019391068	SWD 60X60	60	60	6,5	6	15,7	4,5	3.080	148	214	291
8019391078	SWD 60X80	60	80	6,5	6	19,8	4,5	4.140	200	289	392
8019391088	SWD 80X60	80	60	6,5	6	15,7	4,5	4.150	200	288	391
8019391098	SWD 80X80	80	80	6,5	6	19,8	4,5	5.660	272	393	534
8019391118	SWD 100X60	100	60	6,5	6	15,7	4,5	5.250	254	364	491
8019391128	SWD 100X80	100	80	6,5	6	19,8	4,5	7.606	255	418	702
8019391138	SWD 100X100	100	100	6,5	6	19,8	4,5	8.920	430	619	812

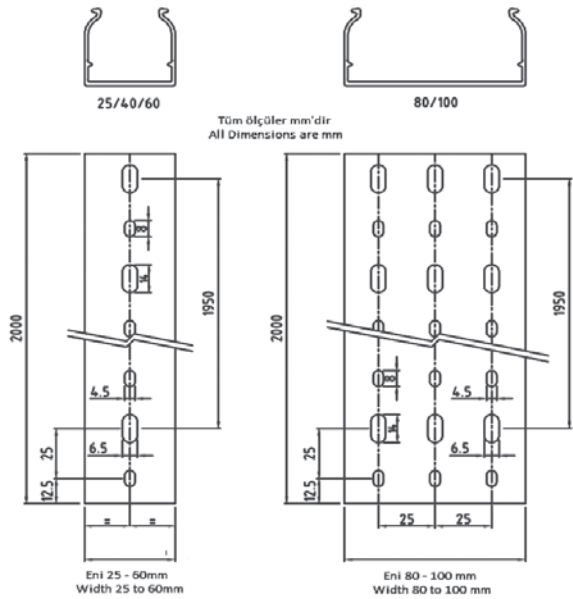
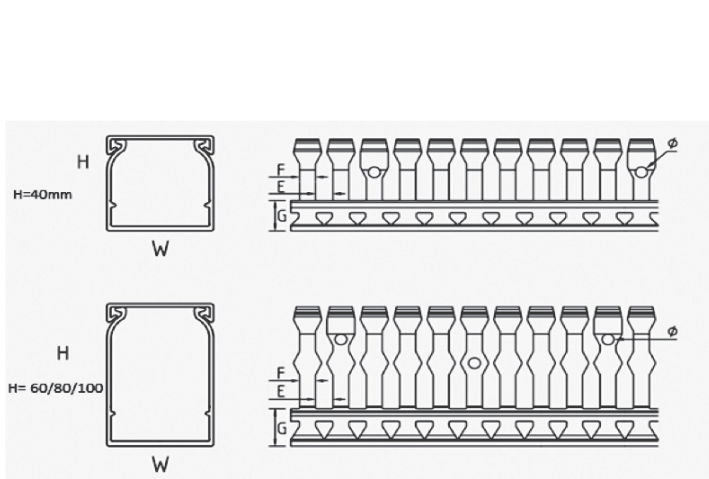

- Kanallar ve kapaklar 2 mt. lik boyda kesilmiş ve paketlenmiştir.
- Wiring ducts and covers are cut and packed in 2 m length.

LAZER YAZICI

LASER PRINTER

Ribbon, mürekkep kullanımı yok.

Ömür boyu silinmez markalama

1 saniyede 10 karakteri markalar

Uzun süreli kullanım için Endüstriyel ve Dayanıklı Tasarım

Metal ve plastik markalama için tek platform

20W fiber lazer

EN 60825-1 uyumluluk

No need for ribbon and/or ink.

Everlasting Printing

Prints 10 letter characters/sec

Industrial and robust design for long run usage

Single platform for plastic and metal marking

20W fiber laser

Compliance with EN 60825-1



PROLASE EKOSİSTEMİ

PROLASE ECOSYSTEM

Yeni **lazer yazıcı ekosistemimiz**, endüstriyel etiketleme süreçlerinde standartları yeniden tanımlıyor. **Prolase yazılımı** sayesinde Eplan, WSCAD programlarında oluşturduğunuz markalama verilerini doğrudan aktarabilir ve markalamaya hatasız bir şekilde başlayabilirsiniz. Sırf malzemeye ihtiyaç duymadan, lazer teknolojisinin sunduğu **hız, dayanıklılık ve mükemmel hassasiyetle** etiketlerinizi kalıcı hale getirin. Artık baskı değil, **lazer keskinliğinde mükemmellik zamanı**.

Our new **laser printer ecosystem** is redefining standards in industrial labeling processes. With **Prolase software**, you can easily design label templates, prepare your data, and send it to the laser printer with a single click. Thanks to **Prolase software**, you can directly import the marking data you created in Eplan or WSCAD and start marking without human error. It's no longer about printing — it's about **laser-sharp perfection**.



YAZILIM

SOFTWARE

WSCAD - Eplan aktarım
WSCAD - eplan Export

Manuel çalışma alanı
Manual workspace

Excel aktarım
Excel export

Çoklu dil desteği
Multi-language support

Kullanıcı dostu arayüz
User-Friendly interface



FIKSTURLER

FIXTURES

ETİKETLER

TAGS

Metal etiketler
Metal tags

Plastik etiketler
Plastic tags

Alüminyum etiketler
Aluminum tags

Klemens etiketleri
Marking tags

Kablo etiketleri
Cable tags

LAZER YAZICI

LASER PRINTER

LAZER YAZICI LASER PRINTER

Ürün Kodu Product Code	Ürün Adı Product Name	Amb. Mik. Pack. Qty. (Ad./Pcs.)	Birim Fiyatı Unit Price TL
8030121000	PROLASE LAZER YAZICI / PROLASE LASER PRINTER	1	SORUNUZ



PAKET İÇERİĞİ INCLUDED IN THE PACKAGE

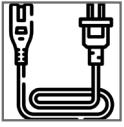

Güç Kablosu
Power Cable

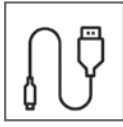

Data Kablosu
Data Cable

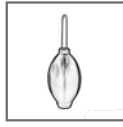

Lens Pompası
Lens Pump



Latex Eldiven
Latex Gloves



Şişe
Bottle

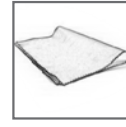

Temizlik Bezi
Cleaning Cloth



Lisans USB
Licence USB

AKSESUARLAR ACCESSORIES

VAKUM TEMİZLEME CİHAZLARI / VACUUM CLEANING DEVICES

Ürün Kodu Product Code	Ürün Adı Product Name	Amb. Mik. Pack. Qty. (Ad./Pcs.)	Birim Fiyatı Unit Price
8030122001	RENFERT SILENT VAKUM TEMİZLEYİCİ / RENFERT SILENT VACUUM	1	SORUNUZ
8030122002	SN-FAN SET SALLYANGOZ FAN VAKUM TEMİZLEYİCİ / SN-FAN SET SNAIL FAN VACUUM CLEANER	1	SORUNUZ



FİKSTÜRLER / FIXTURES

Ürün Kodu Product Code	Ürün Adı Product Name	Amb. Mik. Pack. Qty. (Ad./Pcs.)	Birim Fiyatı Unit Price
8030130010	FIXT LTG-O LAZER YAZICI FIKSTÜRÜ / FIXT LTG-O LASER PRINT FIXTURE	1	SORUNUZ
8030130020	FIXT LTG-5,2 LAZER YAZICI FIKSTÜRÜ / FIXT LTG-5.2 LASER PRINT FIXTURE	1	SORUNUZ
8030130030	FIXT LTG-N LAZER YAZICI FIKSTÜRÜ / FIXT LTG-N LASER PRINT FIXTURE	1	SORUNUZ
8030130040	FIXT ALTG-GEN LAZER YAZICI FIKSTÜRÜ / FIXT LTG-GEN LASER PRINT FIXTURE	1	SORUNUZ
8030130050	FIXT ALTG-1 LAZER YAZICI FIKSTÜRÜ / FIXT LTG-1 LASER PRINT FIXTURE	1	SORUNUZ
8030130060	FIXT ICTG LAZER YAZICI FIKSTÜRÜ / FIXT ICTG LASER PRINTER FIXTURE	1	SORUNUZ
8030130070	FIXT TCTG LAZER YAZICI FIKSTÜRÜ / FIXT TCTG LASER PRINTER FIXTURE	1	SORUNUZ
8030130080	FIXT SCTG LAZER YAZICI FIKSTÜRÜ / FIXT SCTG LASER PRINTER FIXTURE	1	SORUNUZ



KLEMENS ETİKETLERİ
MARKING TAGS

LAZER KLEMENS ETİKETLERİ / LASER MARKING TAGS

Ürün Kodu Product Code	Ürün Adı Product Name	Uyumlu Markalar Compatible Brands	Açıklama Explanation	Ebatlar Size(mm)	Amb. Mik. Pack. Qty. (Ad./Pcs.)	Birim Fiyatı Unit Price TL
8020370009	LTG 5X6 BOŞ / LTG 5X6 BLANK	TBLOC, Weidmueller, Klemsan, Onka	BOŞ BLANK	Klemens Etiketi Marking Tag	500	2,33
8020371009	LTG 6X6 BOŞ / LTG 6X6 BLANK	TBLOC, Weidmueller, Klemsan, Onka				2,61
8020372009	LTG 6,4X6 BOŞ / LTG 6,4X6 BLANK	TBLOC, Weidmueller, Klemsan, Onka				2,98
8020373009	LTG 8X7 BOŞ / LTG 8X7 BLANK	TBLOC, Weidmueller, Klemsan, Onka				2,96
8020374009	LTG 10X7 BOŞ / LTG 10X7 BLANK	TBLOC, Weidmueller, Klemsan, Onka				6,25
8020375009	LTG 5,2X10 BOŞ / LTG 5,2X10 BLANK	TBLOC, Weidmueller, Klemsan, Onka				4,19
8020370019	LTG 5X6 BASKILI / LTG 5X6 PRINTED	TBLOC, Weidmueller, Klemsan, Onka	BASKILI PRINTED	Klemens Etiketi Marking Tag	500	4,33
8020371019	LTG 6X6 BASKILI / LTG 6X6 PRINTED	TBLOC, Weidmueller, Klemsan, Onka				4,61
8020372019	LTG 6,4X6 BASKILI / LTG 6,4X6 PRINTED	TBLOC, Weidmueller, Klemsan, Onka				4,98
8020373019	LTG 8X7 BASKILI / LTG 8X7 PRINTED	TBLOC, Weidmueller, Klemsan, Onka				4,96
8020374019	LTG 10X7 BASKILI / LTG 10X7 PRINTED	TBLOC, Weidmueller, Klemsan, Onka				8,25
8020375019	LTG 5,2X10 BASKILI / LTG 5,2X10 PRINTED	TBLOC, Weidmueller, Klemsan, Onka				6,19
8020375109	LTG 5X10 PC BOŞ / LTG 5X10 PC BLANK	Phoenix Contact	Klemens Etiketi Marking Tags	5x10	1.000	1,08
8020375119	LTG 5X10 PC BASKILI / LTG 5X10 PC PRINTED	Phoenix Contact		5x10	1.000	3,08

UYUMLU FİKSTÜR / COMPATIBLE FIXTURE



LTG 5.2X10

PFT 2,5 PUSH-IN VE NTB 2,5 VİDALI KLEMENSLERİMİZ İLE UYUMLUDUR.
COMPATIBLE WITH OUR PFT 2.5 PUSH-IN AND NTB 2.5 SCREW TERMINAL BLOCKS.

Ürün Adı Product Name	LTG 5.2X10	LTG 5X6	LTG 6X6	LTG 6,4X6	LTG 8X7	LTG 10X7
Kullanıldığı Klemens Used with	NTB 2,5, PFT 2,5	NTB 2,5, PFT 2,5	NTB 4, PFT 4, TBL 2,5	TBL 4	NTB 6, PFT 6, TBL 6	NTB 10, PFT 10, TBL 10



UYUMLU FİKSTÜR / COMPATIBLE FIXTURE

8030130010 | Fixt Ltg-o Lazer Yazıcı Fikstürü
Fixt Ltg-o Laser Print Fixture

8030130020 | Fixt Ltg-5,2 Lazer Yazıcı Fikstürü
Fixt Ltg-5.2 Laser Print Fixture

KABLO ETİKETLERİ
CABLE TAGS

ŞEFFAF TÜP KABLO ETİKETLERİ / TUBE ENTRY CABLE MARKING TAGS

Ürün Kodu Product Code	Ürün Adı Product Name	Açıklama Explanation	Amb. Mik. Pack. Qty. (Ad./Pcs.)	Birim Fiyatı Unit Price TL
8021307009	TCTG 12X4 W	Tüp İçi Kablo Etiketi <i>Tube Entry Cable Marking Tag</i>	600	5,20
8021307109	TCTG 15x4 W		800	6,33
8021307209	TCTG 18X4 W		600	6,63
8021307309	TCTG 23X4 W		600	7,70

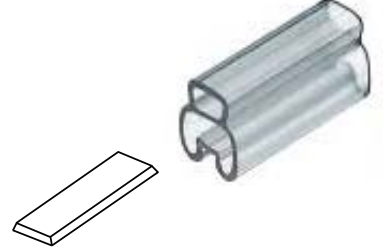

ŞEFFAF TÜPLER / TRANSPARENT SLEEVES - CLOSED / INSERTION TYPE

Ürün Kodu Product Code	Ürün Adı Product Name	Açıklama Explanation	Renk Color	Amb. Mik. Pack. Qty. (Ad./Pcs.)	Birim Fiyatı Unit Price TL
8021357009	LTS 12 0,35-1,0	Bu tabloda listelenen şeffaf tüpler, sadece TCTG serisi ürünlerle uyumluluk göstermektedir. <i>The transparent tubes listed in this table are compatible only with TCTG series products.</i>	Şeffaf <i>Transparent</i>	3.000	2,18
8021357019	LTS 12 1,0-2,5			3.000	2,18
8021357029	LTS 12 2,5-6,0			1.000	2,18
8021357039	LTS 12 6,0-25			500	3,56
8021357049	LTS 15 0,35-1,0			3.000	2,48
8021357059	LTS 15 1,0-2,5			3.000	2,48
8021357069	LTS 15 2,5-6,0			1.000	2,48
8021357079	LTS 15 6,0-25			500	3,77
8021357089	LTS 18 0,35-1,0			3000	3,10
8021357099	LTS 18 1,0-2,5			3000	3,20
8021357109	LTS 18 2,5-6,0			1000	3,20
8021357119	LTS 18 6,0-25			500	4,12
8021357129	LTS 23 0,35-1,0			3000	3,88
8021357139	LTS 23 1,0-2,5			3000	4,12
8021357149	LTS 23 2,5-6,0			1000	5,85
8021357159	LTS 23 6,0-25			500	6,95



UYUMLU FİKSÜR
COMPATIBLE FIXTURE

8030130070 | TCTG Tüp İçi Kablo Etiketi için Fiksür
Fixture for TCTG Tube Entry Cable Markers

KABLO ETİKETLERİ
CABLE TAGS

GEÇİŞLİ KABLO ETİKETLERİ / INLET CABLE MARKING TAGS

Ürün Kodu Product Code	Ürün Adı Product Name	Açıklama Explanation	Amb. Mik. Pack. Qty. (Ad./Pcs.)	Birim Fiyatı Unit Price TL
8021308009	ICTG 1 12 W (0,5-1,5 MM2)	Geçişli Kablo Etiketi Inlet Cable Marking Tag	600	5,83
8021308109	ICTG 1 16 W (0,5-1,5 MM2)		600	5,83
8021309009	ICTG 2 12 W (1,0-6,0 MM2)		600	6,45
8021309109	ICTG 2 16 W (1,0-6,0 MM2)		600	6,45

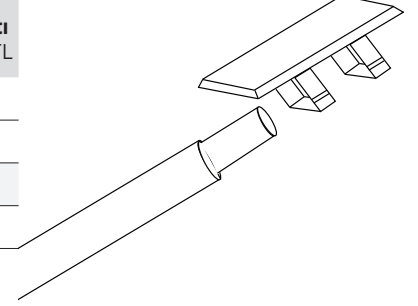

Kablo etiketin alt kısmının içinden geçirilerek montaja hazırlanır.

Cable should pass through the bottom side of the marking tag before assembly.



UYUMLU FİKSTÜR / COMPATIBLE FIXTURE

8030130060 | ICTG Geçişli Kablo Etiketi için Fikstür
Fixture for ICTG Inlet Cable Markers

KABLO ETİKETLERİ
CABLE TAGS



Lazer yazıcımız ile tam uyumlu üstten geçmeli kablo etiketleri çok yakında stoklarımızda!

Laser-compatible wrap-around cable labels are coming to our stock very soon!

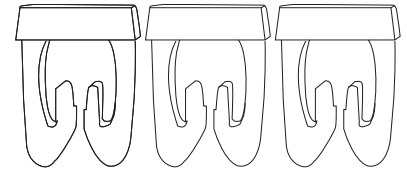
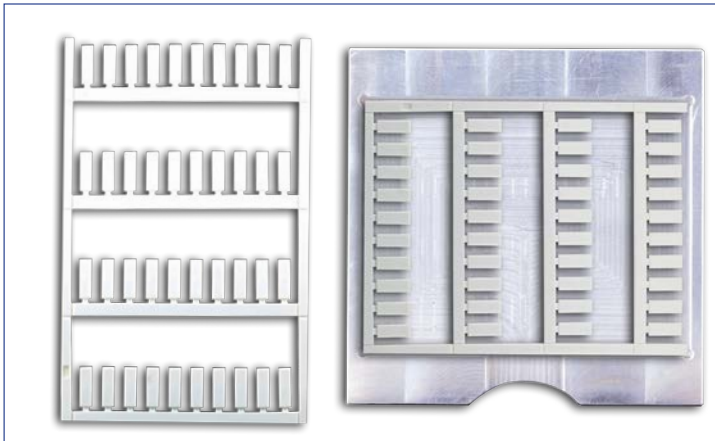

Kablonun üzerinden geçirelerek takılır

It is installed by passing it over the cable

ALÜMİNYUM ETİKETLER
ALUMINUM TAGS

ALÜMİNYUM YÜZEY ETİKETLERİ / ALUMINUM TAGS

Ürün Kodu Product Code	Ürün Adı Product Name	Açıklama Explanation	Renk Color	Amb. Mik. Pack. Qty. (Ad./Pcs.)	Birim Fiyatı Unit Price TL
8022710000	ALTG 60X30	Eloksal anodize kaplamalı 5005 kalite alüminyum 5005 grade aluminium with anodized coating	Siyah / Black	10	129,60
8022710010	ALTG 35X18			10	62,40
8022710020	ALTG 120X120			10	924,00
8022710030	ALTG 120X100			10	720,00
8022710040	ALTG 120X80			10	600,00
8022710050	ALTG 100X100			10	552,00
8022710060	ALTG 100X80			10	462,00
8022710070	ALTG 100X60			10	348,00
8022710080	ALTG 80X80			10	372,00
8022710090	ALTG 80X60			10	276,00

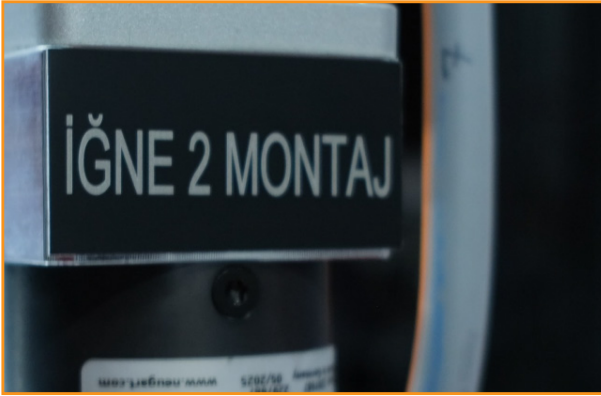

ALTG 60X30

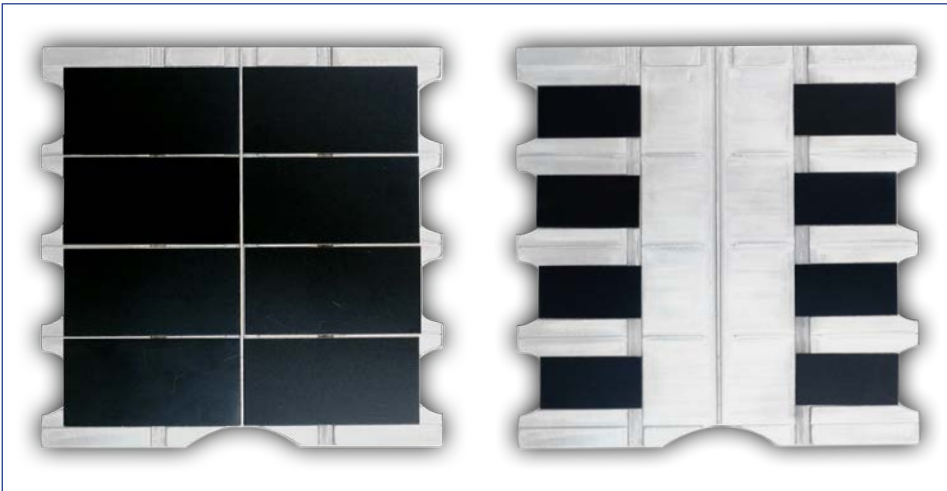

UYUMLU FIKSTÜR / COMPATIBLE FIXTURE



8030130040 Fixt Altg-gen Lazer Yazıcı Fikstürü
Fixt Ltg-gen Laser Print Fixture

8030130050 Fixt Altg-1 Lazer Yazıcı Fikstürü
Fixt Ltg-1 Laser Print Fixture



Termal Transfer Yazıcı

Thermal Transfer Printer

Ürün Kodu Product Code	Ürün Adı Product Name	Amb. Mik. Pack. Qty. (Ad./Pcs.)	Birim Fiyatı Unit Price (TL/Adet)
8030129000	TBL TP2 Termal Yazıcı / Thermal Printer	1	Sorunuz



Ribonlar

Ribbons

Ürün Kodu Product Code	Ürün Adı Product Name	İç Çap Inner Diameter (mm)	Ölçüler Dimensions (mmxm)	Renk Color	Amb. Mik. Pack. Qty. (Ad./Pcs.)	Birim Fiyatı Unit Price (TL/Adet)
8030129120	RR Ribbon 50x300	25,4 (1 inch)	50x300	Siyah / Black	1	6.040,32
8030129130	RR Ribbon 110x300	25,4 (1 inch)	110x300	Siyah / Black	1	13.539,24



Klemensler için Şerit Etiket

Terminal Blocks Strip Label

Ürün Kodu Product Code	Ürün Adı Product Name	Ölçüler Dimensions (mmxm)	Renk Color	Rulo Etiket Adedi Labels per Roll	Amb. Mik. Pack. Qty. (Ad./Pcs.)	Birim F. Unit Price (TL/Adet)
8020384009	TBSL 22X20	22x20	Beyaz White	2 adet Şerit Etiket 2 pcs. of Strip Label	1	3.439,15
8020384009	TBSL 22x20 (Sarı-Beyaz / Yellow-white)	22x20	Sarı Yellow	2 sıra Şerit Etiket 2 pcs. of Strip Label	1	3.439,15
8020384011	TBSL 5,15x5	25,75x20	Beyaz White	5 adet Şerit Etiket 5 pcs. of Strip Label	1	3.595,48

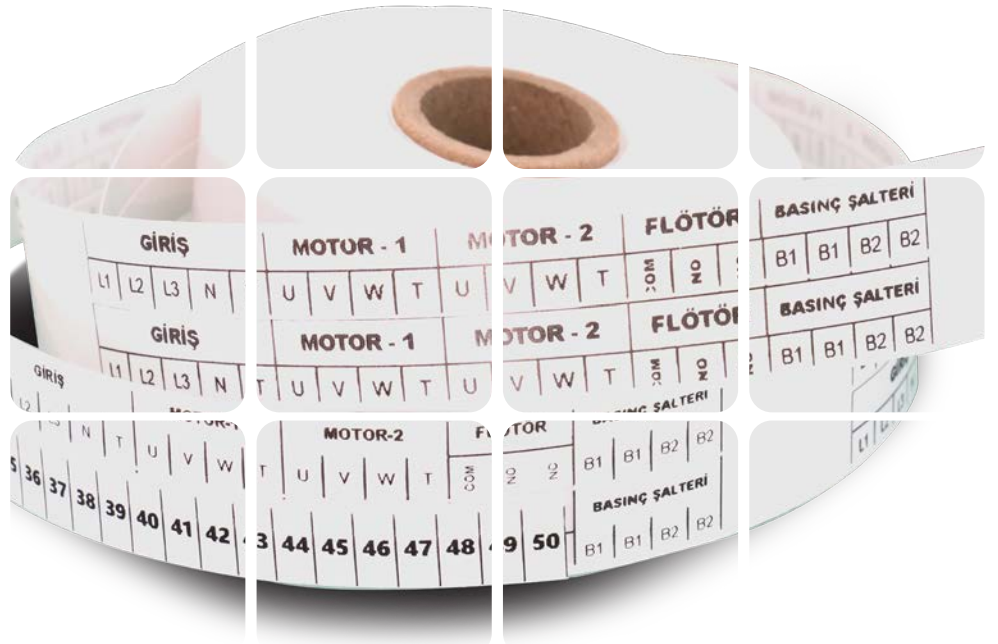

TBSL 22X20

Kablo İşaretleme Plakaları (Şeffaf Tüpler için)

Cable Marking Plates (for Transparent Sleeves)



TSL 10x4
ön yüz
front side

TSL 10x4
arka yüz
back side

Ürün Kodu Product Code	Ürün Adı Product Name	Yazım Alanı Print Area (mm)	Açıklama Explanation	Amb. Mik. Pack. Qty. (Ad./Pcs.)	Birim Fiyatı Unit Price (TL/Rulo)	Adet Fiyatı Pcs. Price (TL/Ad.)
8021340004	TSL 10x4 Sarı - Beyaz / Yellow - White	10 x 4	Katlamalı Folded	3.000	14.940,00	4,98
8021340104	TSL 12x4 Sarı - Beyaz / Yellow - White	12 x 4	Katlamalı Folded	3.000	15.780,00	5,27
8021340014	TSL 15x4 Sarı - Beyaz / Yellow - White	15 x 4	Katlamalı Folded	4.000	21.520,00	5,39
8021340024	TSL 20x4 Sarı - Beyaz / Yellow - White	20 x 4	Katlamalı Folded	3.000	18.450,00	6,16
8021340034	TSL 30x4 Sarı - Beyaz / Yellow - White	30 x 4	Katlamalı Folded	3.000	24.210,00	8,08

Şeffaf Tüpler

Transparent Sleeves - Closed / Insertion Type



TS 10 1,5-2,5



TS 10 2,5-4,0



TS 10 6,0-10



TS 10 16-25

Ürün Kodu Product Code	Ürün Adı Product Name	Uzunluk Length (mm)	Renk Color	İletken Kesit Cond. Cross Sec. (mm ²)	Amb. Mik. Pack. Qty. (Ad./Pcs.)	Birim Fiyatı Unit Price (TL/Kutu)	Adet Fiyatı Pcs. Price (TL/Ad.)
8021343019	TS 10 1,5-2,5	10	Şeffaf / Transparent	1,5 - 2,5	500	1.445,00	2,89
8021343029	TS 12 1,5-2,5	12	Şeffaf / Transparent	1,5 - 2,5	500	2.010,00	4,02
8021343039	TS 15 1,5-2,5	15	Şeffaf / Transparent	1,5 - 2,5	500	2.010,00	4,02
8021343049	TS 20 1,5-2,5	20	Şeffaf / Transparent	1,5 - 2,5	500	2.730,00	5,46
8021343059	TS 30 1,5-2,5	30	Şeffaf / Transparent	1,5 - 2,5	500	5.320,00	10,64
8021344019	TS 10 2,5-4,0	10	Şeffaf / Transparent	2,5 - 4	500	1.870,00	3,74
8021344029	TS 12 2,5-4,0	12	Şeffaf / Transparent	2,5 - 4	500	2.305,00	4,61
8021344039	TS 15 2,5-4,0	15	Şeffaf / Transparent	2,5 - 4	500	2.590,00	5,18
8021344049	TS 20 2,5-4,0	20	Şeffaf / Transparent	2,5 - 4	500	2.885,00	5,77
8021344059	TS 30 2,5-4,0	30	Şeffaf / Transparent	2,5 - 4	500	5.600,00	11,20
8021345019	TS 10 6,0-10	10	Şeffaf / Transparent	6 - 10	500	2.095,00	4,19
8021345029	TS 12 6,0-10	12	Şeffaf / Transparent	6 - 10	500	2.590,00	5,18
8021345039	TS 15 6,0-10	15	Şeffaf / Transparent	6 - 10	500	2.730,00	5,46
8021345049	TS 20 6,0-10	20	Şeffaf / Transparent	6 - 10	500	3.745,00	7,49
8021345059	TS 30 6,0-10	30	Şeffaf / Transparent	6 - 10	500	6.040,00	12,08
8021346019	TS 10 16-25	10	Şeffaf / Transparent	16 - 25	500	2.730,00	5,46
8021346029	TS 12 16-25	12	Şeffaf / Transparent	16 - 25	500	3.310,00	6,62
8021346039	TS 15 16-25	15	Şeffaf / Transparent	16 - 25	500	3.745,00	7,49
8021346049	TS 20 16-25	20	Şeffaf / Transparent	16 - 25	200	1.958,00	9,79
8021346059	TS 30 16-25	30	Şeffaf / Transparent	16 - 25	200	3.228,00	16,14

İnce Yapışkanlı Etiketler (Pano Yüzeyi, Kontaktör ve Pano İçi Diğer Cihazlar için)

Slim Adhesive Labels (For Panel Surface, Contactors and Other Devices Inside Panel)

Ürün Kodu Product Code	Ürün Adı Product Name	Yazım Alanı Print Area (mm)	Renk Color	Amb. Mik. Pack. Qty. (Ad./Pcs.)	Birim Fiyatı Unit Price (TL/Rulo)	Adet Fiyatı Pcs. Price (TL/Ad.)
8022120004	SPEL 12x9	12x9	Sarı / Yellow	2.500	3.050,00	1,22
8022120008	SPEL 12x9	12x9	Gümüş / Silver	2.500	3.050,00	1,22
8022120009	SPEL 12x9	12x9	Beyaz / White	2.500	3.050,00	1,22
8022120014	SPEL 15x6	15x6	Sarı / Yellow	2.500	3.175,00	1,27
8022120018	SPEL 15x6	15x6	Gümüş / Silver	2.500	3.175,00	1,27
8022120019	SPEL 15x6	15x6	Beyaz / White	2.500	3.175,00	1,27
8022120024	SPEL 15x9	15x9	Sarı / Yellow	2.500	4.775,00	1,91
8022120028	SPEL 15x9	15x9	Gümüş / Silver	2.500	4.775,00	1,91
8022120029	SPEL 15x9	15x9	Beyaz / White	2.500	4.775,00	1,91
8022120034	SPEL 17x10	17x10	Sarı / Yellow	2.500	4.775,00	1,91
8022120038	SPEL 17x10	17x10	Gümüş / Silver	2.500	4.775,00	1,91
8022120039	SPEL 17x10	17x10	Beyaz / White	2.500	4.775,00	1,91
8022120044	SPEL 18x8	18x8	Sarı / Yellow	2.500	4.925,00	1,97
8022120048	SPEL 18x8	18x8	Gümüş / Silver	2.500	4.925,00	1,97
8022120049	SPEL 18x8	18x8	Beyaz / White	2.500	4.925,00	1,97
8022120054	SPEL 27x12,5	27x12	Sarı / Yellow	2.500	9.800,00	3,92
8022120058	SPEL 27x12,5	27x12	Gümüş / Silver	2.500	9.800,00	3,92
8022120059	SPEL 27x12,5	27x12	Beyaz / White	2.500	9.800,00	3,92
8022120064	SPEL 27x15	27x15	Sarı / Yellow	2.500	10.375,00	4,15
8022120068	SPEL 27x15	27x15	Gümüş / Silver	2.500	10.375,00	4,15
8022120069	SPEL 27x15	27x15	Beyaz / White	2.500	10.375,00	4,15
8022120074	SPEL 27x18	27x18	Sarı / Yellow	2.500	11.250,00	4,50
8022120078	SPEL 27x18	27x18	Gümüş / Silver	2.500	11.250,00	4,50
8022120079	SPEL 27x18	27x18	Beyaz / White	2.500	11.250,00	4,50
8022120098	SPEL 35x18	35x18	Gümüş / Silver	1.500	6.480,00	5,18
8022120108	SPEL 45x15	45x15	Gümüş / Silver	2.000	8.900,00	5,34
8022120118	SPEL 70x30	70x30	Gümüş / Silver	250	8.900,00	21,90
8022120128	SPEL 90x40	90x40	Gümüş / Silver	250	8.900,00	23,96
8022120138	SPEL 100x50	100x50	Gümüş / Silver	250	8.900,00	25,61



SPEL 27x15



SPEL 35x15



SPEL 15x6

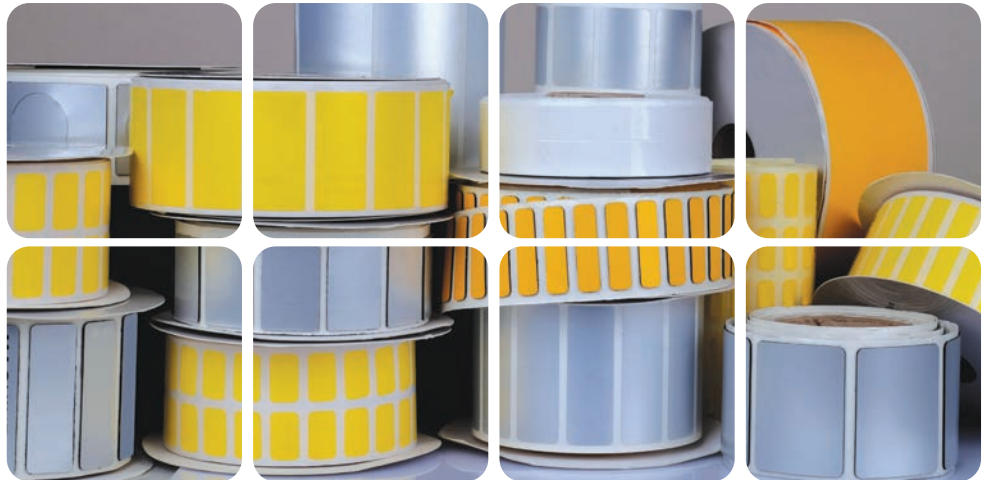

Kalın Yapışkanlı Etiketler (Pano Yüzeyi için)

Thick Adhesive Labels (For Panel Surface)



TPEL 40x30

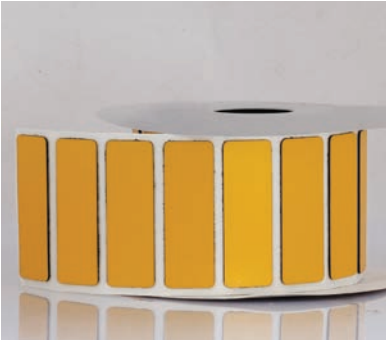

TPEL 60x15

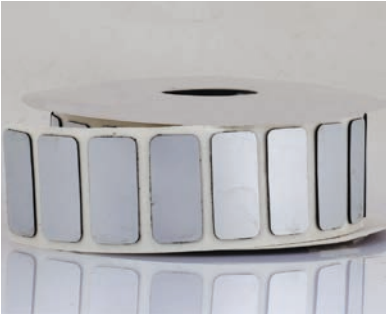

TPEL 45x15

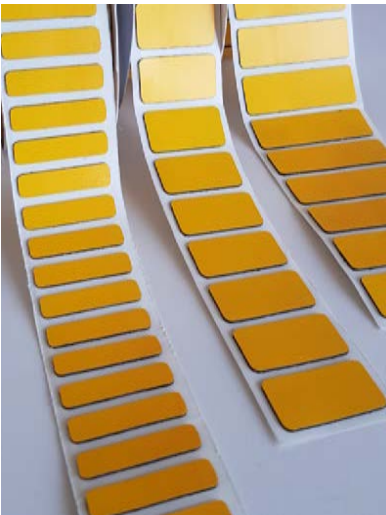

Ürün Kodu Product Code	Ürün Adı Product Name	Yazım Alanı Print Area (mm)	Renk Color	Amb. Mik. Pack. Qty. (Ad./Pcs.)	Birim Fiyatı Unit Price (TL/Rulo)	Adet Fiyatı Pcs. Price (TL/Ad.)
8022130014	TPEL 22x22	22x22	Sarı / Yellow	150	7.482,00	49,88
8022130018	TPEL 22x22	22x22	Gümüş / Silver	150	7.482,00	49,88
8022130019	TPEL 22x22	22x22	Beyaz / White	150	5.320,50	49,88
8022130004	TPEL 27x12,5	27x12	Sarı / Yellow	150	5.320,50	35,47
8022130008	TPEL 27x12,5	27x12	Gümüş / Silver	150	5.320,50	35,47
8022130009	TPEL 27x12,5	27x12	Beyaz / White	150	6.195,00	35,47
8022130024	TPEL 27x15	27x15	Sarı / Yellow	150	6.195,00	41,30
8022130028	TPEL 27x15	27x15	Gümüş / Silver	150	6.195,00	41,30
8022130029	TPEL 27x15	27x15	Beyaz / White	150	6.645,00	41,30
8022130109	TPEL 27x18	27x18	Beyaz / White	150	6.645,00	41,30
8022130108	TPEL 27x18	27x18	Gümüş / Silver	150	6.645,00	41,30
8022130104	TPEL 27x18	27x18	Sarı / Yellow	150	8.649,00	41,30
8022130034	TPEL 27x27	27x27	Sarı / Yellow	150	8.649,00	57,66
8022130038	TPEL 27x27	27x27	Gümüş / Silver	150	8.649,00	57,66
8022130039	TPEL 27x27	27x27	Beyaz / White	150	9.216,00	57,66
8022130044	TPEL 35x18	35x18	Sarı / Yellow	150	9.216,00	61,44
8022130048	TPEL 35x18	35x18	Gümüş / Silver	150	9.216,00	61,44
8022130049	TPEL 35x18	35x18	Beyaz / White	150	12.682,50	61,44
8022130054	TPEL 40x30	40x30	Sarı / Yellow	125	12.682,50	101,46
8022130058	TPEL 40x30	40x30	Gümüş / Silver	125	12.682,50	101,46
8022130059	TPEL 40x30	40x30	Beyaz / White	125	11.806,50	101,46
8022130064	TPEL 45x15	45x15	Sarı / Yellow	150	11.806,50	78,71
8022130068	TPEL 45x15	45x15	Gümüş / Silver	150	11.806,50	78,71
8022130069	TPEL 45x15	45x15	Beyaz / White	150	14.415,00	78,71
8022130074	TPEL 60x15	60x15	Sarı / Yellow	150	14.415,00	96,10
8022130078	TPEL 60x15	60x15	Gümüş / Silver	150	14.415,00	96,10
8022130079	TPEL 60x15	60x15	Beyaz / White	150	16.131,25	96,10
8022130084	TPEL 60x30	60x30	Sarı / Yellow	125	16.131,25	129,05
8022130088	TPEL 60x30	60x30	Gümüş / Silver	125	16.131,25	129,05
8022130089	TPEL 60x30	60x30	Beyaz / White	125	10.090,00	129,05
8022130094	TPEL 90x45	90x45	Sarı / Yellow	50	10.090,00	201,80
8022130098	TPEL 90x45	90x45	Gümüş / Silver	50	10.090,00	201,80
8022130099	TPEL 90x45	90x45	Beyaz / White	50	10.090,00	201,80



Buton Etiketleri (22 mm Çapa Uygun)

Push Button Labels (Suitable for 22 mm Diameter)



TPBL 30x40

Ürün Kodu Product Code	Ürün Adı Product Name	Yazım Alanı Print Area (mm)	Renk Color	Delik Çapı Hole Dia. (mm)	Amb. Mik. Pack. Qty. (Ad./Pcs.)	Birim Fiyatı Unit Price (TL/Rulo)	Adet Fiyatı Pcs. Price (TL/Ad.)
8022130114	TPBL 30x40	30 x 13	Sarı / Yellow	23,5	100	8.203,00	82,03
8022130118	TPBL 30x40	30 x 13	Gümüş / Silver	23,5	100	8.203,00	82,03
8022130119	TPBL 30x40	30 x 13	Beyaz / White	23,5	100	8.203,00	82,03



TPBL 30x40

Buton Etiket Tutucular (22 mm Çapa Uygun)

Push Button Labels (Suitable for 22 mm Diameter)



TBET 50X30 TBET 40X30

Ürün Kodu Product Code	Ürün Adı Product Name	Yazım Alanı Print Area (mm)	Renk Color	Amb. Mik. Pack. Qty. (Ad./Pcs.)	Birim Fiyatı Unit Price (TL/Amb.)	Adet Fiyatı Pcs. Price (TL/Ad.)
8022130330	TBET 40X30	25 x 8	Siyah / Black	60	1.802,40	30,04
8022130340	TBET 50X30	25 x 18	Siyah / Black	60	1.836,60	30,61

Buton Etiketi (22 mm Çapa Uygun)

Push Button Labels (Suitable for 22 mm Diameter)

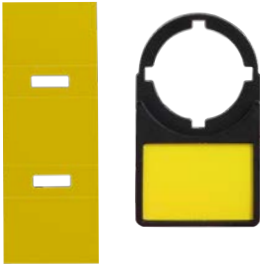

Ürün Kodu Product Code	Ürün Adı Product Name	Yazım Alanı Print Area (mm)	Renk Color	Amb. Mik. Pack. Qty. (Ad./Pcs.)	Birim Fiyatı Unit Price (TL/Amb.)	Adet Fiyatı Pcs. Price (TL/Ad.)
8022130214	TPBL 27x18	25 x 18	Sarı-Beyaz	1000	4.500,00	4,50

Etketin 2 tarafında termal yazıcıda yazıma uygundur. sarı ve beyaz olarak kullanılabilir.

Yapışkanlı Pano Etiket Tutucular

Self Adhesive Panel Labels Holders



TYPET 17x75



TYPET 17x50



TYPET 17x30

Ürün Kodu Product Code	Ürün Adı Product Name	Yazım Alanı Print Area (mm)	Renk Color	Amb. Mik. Pack. Qty. (Ad./Pcs.)	Birim Fiyatı Unit Price (TL/Amb.)	Adet Fiyatı Pcs. Price (TL/Ad.)
8022130300	TYPET 17x30	27 x 14	Siyah / Black	100	2.352,00	23,52
8022130310	TYPET 17x50	49 x 15	Siyah / Black	50	1.373,00	27,46
8022130320	TYPET 17x75	72 x 15	Siyah / Black	25	789,50	31,58

Boş yazım kağıtları paketin içerisinde.

Klemens Grup Etiketleri için Etiketler

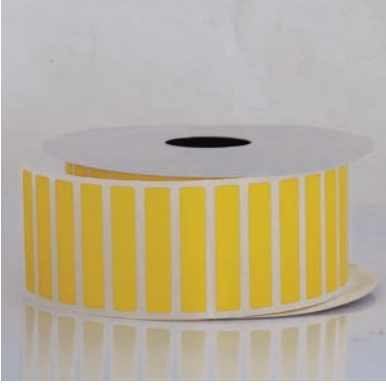

GML 2 36x7

Labels for Terminal Blocks Group Markers

Ürün Kodu Product Code	Ürün Adı Product Name	Yazım Alanı Print Area (mm)	Renk Color	Uyumlu Ürün Explanation	Amb. Mik. Pack. Qty. (Ad./Pcs.)	Birim Fiyatı Unit Price (TL/Rulo)	Adet Fiyatı Pcs. Price (TL/Ad.)
8022130124	GML 1 36x17	36 x 17	Sarı / Yellow	GM 1	2.000	7.780,00	4,46
8022130134	GML 2 36x7	36 x 7	Sarı / Yellow	GM 2	2.000	8.920,00	3,89



Yapışkanlı Bant Etiketler



SALT 5x20

Self Adhesive Endless Labels

Ürün Kodu Product Code	Ürün Adı Product Name	Ölçüler Dimensions (mxm)	Renk Color	Amb. Mik. Pack. Qty. (Ad./Pcs.)	Birim Fiyatı Unit Price (TL/Rulo)
8022130144	SALT 5x20	5 x 20	Sarı / Yellow	1	4804,80
8022130128	SALT 5x20	5 x 20	Gümüş / Silver	1	4804,80
8022130129	SALT 5x20	5 x 20	Beyaz / White	1	4804,80
8022130244	SALT 2x20	2 x 20	Sarı / Yellow	1	2955,00

Acil Stop Etiketleri (22mm Çapa Uygun)



Emergency Stop Labels (Suitable for 22mm Diameter)

Ürün Kodu Product Code	Ürün Adı Product Name	Etiket Çapı Label Dia. (mm)	Delik Çapı Hole Dia. (mm)	Renk Color	Amb. Mik. Pack. Qty. (Ad./Pcs.)	Birim Fiyatı Unit Price (TL/Adet)
8022130350	ASE60	60	23,5	Sarı / Yellow	1	139,43



RCTL 50x15



HCTL 25x10

Kablo Bağı ile Bağlanan Etiketler (Doğrudan Kablo Bağına Takılan)

Labels Assembled with Cable Ties (Directly Assembled to Cable Ties)

Ürün Kodu Product Code	Ürün Adı Product Name	Yazım Alanı Print Area (mm)	Renk Color	Açıklama Explanation	Amb. Mik. Pack. Qty. (Ad./Pcs.)	Birim Fiyatı Unit Price (TL/Rulo)	Adet Fiyatı Pcs. Price (TL/Ad.)
8021341019	HCTL 25x10	25 x 10	Beyaz / White	Altıgen / Hexagonal	250	10.470,00	41,88
8021342019	RCTL 25x10	25 x 10	Beyaz / White	Dikdörtgen / Rectangular	250	10.470,00	41,88
8021342029	RCTL 50x15	50 x 15	Beyaz / White	Dikdörtgen / Rectangular	250	17.590,00	70,36
8021342039	RCTL 60x30	60 x 30	Beyaz / White	Dikdörtgen / Rectangular	250	29.050,00	76,20



CM 1

Kablo Bağı ile Bağlanan Etiketler (Etiket Kılıfıyla Bağlananlar)

Labels Assembled with Cable Ties (Assembled with Label Holder)

Ürün Kodu Product Code	Ürün Adı Product Name	Yazım Alanı Print Area (mm)	Renk Color	Açıklama Explanation	Amb. Mik. Pack. Qty. (Ad./Pcs.)	Birim Fiyatı Unit Price (TL/Amb.)	Adet Fiyatı Pcs. Price (TL/Ad.)
8021334009	CM 1		Beyaz / White	Etiket Kılıfı 1 Label Holder 1	100	893,00	8,93
8021334019	CM 2		Beyaz / White	Etiket Kılıfı 2 Label Holder 2	100	1.300,40	13,04

Boş yazım kağıtları paketin içerisinde.

Ürün Kodu Product Code	Ürün Adı Product Name	Renk Color	Ölçüler Dimensions		
			L	W	T
8021334009	CM 1	Beyaz / White	35	10	8
8021334019	CM 2	Beyaz / White	45	20	8

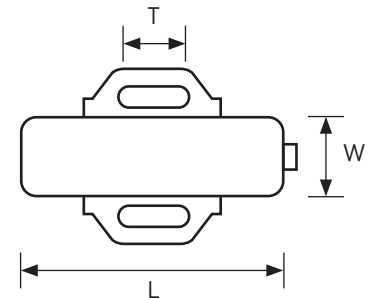

CM 1



tbloc





Plastik Kablo Bağları

Plastic Cable Ties

Ürün Kodu Product Code	Ürün Adı Product Name	Ölçüler (BoyxEn) Dimensions (LxW) (mm)	Maks. Sıkma Çapı Max. Bundle Dia. (mm)	Min. Açılma Mukavemeti Min. Loop Tensile Strenght (kg.)	Amb. Mik. Pack. Qty (Adet/Pcs.)	Koli Mik. Carton Qty. (Adet/Pcs.)	Birim Fiyatı Unit Price (TL/100 Ad.)
8016330109	PCT 100 x 2.5 Beyaz / White	100 x 2.5	22	8	100	26.000	0,66
8016330110	PCT 100 x 2.5 Siyah / Black	100 x 2.5	22	8	100	26.000	0,66
8016330209	PCT 150 x 2.5 Beyaz / White	150 x 2.5	35	8	100	20.000	0,95
8016330210	PCT 150 x 2.5 Siyah / Black	150 x 2.5	35	8	100	20.000	0,95
8016330309	PCT 200 x 2.5 Beyaz / White	200 x 2.5	55	8	100	18.000	1,40
8016330310	PCT 200 x 2.5 Siyah / Black	200 x 2.5	55	8	100	18.000	1,40
8016330409	PCT 140 x 3.6 Beyaz / White	140 x 3.6	36	18	100	12.000	1,53
8016330410	PCT 140 x 3.6 Siyah / Black	140 x 3.6	36	18	100	12.000	1,53
8016330509	PCT 200 x 3.6 Beyaz / White	200 x 3.6	52	18	100	10.000	2,29
8016330510	PCT 200 x 3.6 Siyah / Black	200 x 3.6	52	18	100	10.000	2,29
8016330609	PCT 250 x 3.6 Beyaz / White	250 x 3.6	68	18	100	8.000	2,80
8016330610	PCT 250 x 3.6 Siyah / Black	250 x 3.6	68	18	100	8.000	2,80
8016330709	PCT 280 x 3.6 Beyaz / White	280 x 3.6	82	18	100	8.000	3,35
8016330710	PCT 280 x 3.6 Siyah / Black	280 x 3.6	82	18	100	8.000	3,35
8016330809	PCT 370 x 3.6 Beyaz / White	370 x 3.6	105	18	100	6.000	4,28
8016330810	PCT 370 x 3.6 Siyah / Black	370 x 3.6	105	18	100	6.000	4,28
8016331009	PCT 200 x 4.8 Beyaz / White	200 x 4.8	49	22	100	7.000	3,20
8016331010	PCT 200 x 4.8 Siyah / Black	200 x 4.8	49	22	100	7.000	3,20
8016331209	PCT 250 x 4.8 Beyaz / White	250 x 4.8	68	22	100	6.000	3,91
8016331210	PCT 250 x 4.8 Siyah / Black	250 x 4.8	68	22	100	6.000	3,91
8016331309	PCT 300 x 4.8 Beyaz / White	300 x 4.8	83	22	100	5.000	4,65
8016331310	PCT 300 x 4.8 Siyah / Black	300 x 4.8	83	22	100	5.000	4,65
8016331509	PCT 370 x 4.8 Beyaz / White	370 x 4.8	105	22	100	4.000	5,58
8016331510	PCT 370 x 4.8 Siyah / Black	370 x 4.8	105	22	100	4.000	5,58
8016331709	PCT 430 x 4.8 Beyaz / White	430 x 4.8	125	22	100	3.000	6,89
8016331710	PCT 430 x 4.8 Siyah / Black	430 x 4.8	125	22	100	3.000	6,89
8016332009	PCT 300 x 7.6 Beyaz / White	300 x 7.6	80	55	100	3.000	9,30
8016332010	PCT 300 x 7.6 Siyah / Black	300 x 7.6	80	55	100	3.000	9,30
8016332209	PCT 370 x 7.6 Beyaz / White	370 x 7.6	101	55	100	2.500	10,97
8016332210	PCT 370 x 7.6 Siyah / Black	370 x 7.6	101	55	100	2.500	10,97
8016332309	PCT 450 x 7.6 Beyaz / White	450 x 7.6	128	55	100	2.500	12,83
8016332310	PCT 450 x 7.6 Siyah / Black	450 x 7.6	128	55	100	2.500	12,83
8016332329	PCT 550 x 7.6 Beyaz / White	550 x 7.6	155	55	100	1.500	17,02
8016332320	PCT 550 x 7.6 Siyah / Black	550 x 7.6	155	55	100	1.500	17,02
8016332339	PCT 750 x 7.6 Beyaz / White	750 x 7.6	220	55	100	1.200	23,71
8016332330	PCT 750 x 7.6 Siyah / Black	750 x 7.6	220	55	100	1.200	23,71
8016332409	PCT 600 x 9.0 Beyaz / White	600 x 9.0	160	80	100	1.200	26,14
8016332410	PCT 600 x 9.0 Siyah / Black	600 x 9.0	160	80	100	1.200	26,14
8016332609	PCT 760 x 9.0 Beyaz / White	760 x 9.0	227	80	100	1.200	31,60
8016332610	PCT 760 x 9.0 Siyah / Black	760 x 9.0	227	80	100	1.200	31,60
8016332709	PCT 900 x 9.0 Beyaz / White	900 x 9.0	275	80	100	1.200	37,41
8016332710	PCT 900 x 9.0 Siyah / Black	900 x 9.0	275	80	100	1.200	37,41

- Siyah renkli kablo bağları UV (Ultraviyole) ışınlarına karşı dayanımlıdır.
- Black colored cable ties are UV (Ultraviolet) resistant.



Paslanmaz elik Kablo Bařları - 304 Kalite

Stainless Steel Cable Ties - Grade 304

rn Kodu Product Code	rn Adı Product Name	ller (BoyxEen) Dimensions (LxW) (mm)	Maks. Sıkma apı Max. Bundle Dia. (mm)	Min. Aılma Mukavemeti Min. Loop Tensile Strenght (kg.)	Amb. Mik. Pack. Qty (Adet/Pcs.)	Koli Mik. Carton Qty. (Adet/Pcs.)	Birim Fiyatı Unit Price (TL/Ad.)
8016335010	SSCT 150x4.6	150x4.6	33	55	100	8.000	13,57
8016335020	SSCT 200x4.6	200x4.6	50	55	100	6.000	15,07
8016335030	SSCT 250x4.6	250x4.6	67	55	100	5.000	16,93
8016335040	SSCT 300x4.6	300x4.6	75	55	100	5.000	17,85
8016335050	SSCT 370x4.6	370x4.6	102	55	100	4.000	19,53
8016335060	SSCT 450x4.6	450x4.6	130	55	100	3.000	21,76
8016335070	SSCT 520x4.6	520x4.6	152	55	100	3.000	24,54
8016335080	SSCT 680x4.6	680x4.6	203	55	100	2.000	30,12
8016335090	SSCT 840x4.6	840x4.6	254	55	100	1.000	36,44
8016335100	SSCT 200x7.9	200x7.9	50	120	100	5.000	21,57
8016335110	SSCT 300x7.9	300x7.9	75	120	100	4.000	24,17
8016335120	SSCT 370x7.9	370x7.9	102	120	100	3.000	27,14
8016335130	SSCT 450x7.9	450x7.9	130	120	100	3.000	32,72
8016335140	SSCT 520x7.9	520x7.9	152	120	100	2.000	36,44
8016335150	SSCT 680x7.9	680x7.9	203	120	100	2.000	46,11
8016335160	SSCT 840x7.9	840x7.9	254	120	100	1.000	51,51
8016335170	SSCT 1000x7.9	1000x7.9	305	120	100	1.000	68,78



Teknik zellikler

Technical Futures

Malzeme / Material	304 kalite Paslanmaz elik / 304 grade Stainless Steel
Su Emilimi / Water Absorption	Yok / No
Alev Yrmeme / Flame Retardant	UL94V-2
UV Dayanıklılıęı / UV Resistance	Mkemmел / Excellent
Kimyasal Dayanım / Chemical Resistance	Mkemmел / Excellent
alıřma Sıcaklıęı / Operating Temperature	-80°C + 538°C

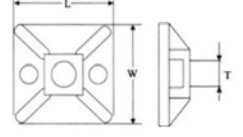

Yapışkan Kroşeler

Self Adhesive Tie Mounts

Ürün Kodu Product Code	Ürün Adı Product Name	Ölçüler Dimensions (mm)			Amb. Mik. Pack. Qty (Adet/Pcs.)	Birim Fiyatı Unit Price (TL/100 Adet)
		L	W	T		
8016333009	ATM 19 x 19 Beyaz / White	19	19	3,6	100	2,90
8016333010	ATM 19 x 19 Siyah / Black	19	19	3,6	100	2,90
8016333109	ATM 28 x 28 Beyaz / White	28	28	4,8	100	4,88
8016333110	ATM 28 x 28 Siyah / Black	28	28	4,8	100	4,88

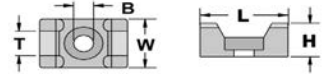

Vidalı Kroşeler

Screw Type Tie Mounts

Ürün Kodu Product Code	Ürün Adı Product Name	Ölçüler Dimensions					Amb. Mik. Pack. Qty (Adet/Pcs.)	Birim Fiyatı Unit Price (TL/100 Adet)
		L	W	H	T	B		
8016334009	STM 1 Beyaz / White	17,8	12,7	8,15	4,8	M3	250	2,11
8016334019	STM 2 Beyaz / White	25,4	16	10,8	9	M5	250	2,11
8016334010	STM 1 Siyah / Black	17,8	12,7	8,15	4,8	M3	250	2,83
8016334020	STM 2 Siyah / Black	25,4	16	10,8	9	M5	250	2,83



Kablo Bağı Aleti

Cable Tie Tool

Ürün Kodu Product Code	Ürün Adı Product Name	Özellik Function	Maks. Kablo Bağı Eni Max. Cable Tie Width (mm)	Amb. Mik. Pack. Qty (Adet/Pcs.)	Birim Fiyatı Unit Price (TL/Adet)
8016334200	CTT1	Sıkma + Kesme Tightening + Cutting	4,8	1	2059,20

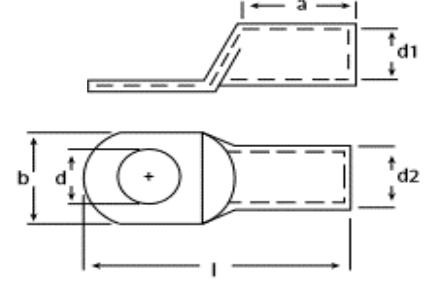

Eko Seri Sıkmalı Kablo Pabuçları

Economical Compression Cable Lugs

Ürün Kodu Product Code	Ürün Adı Product Name	Kesit Cross Sec. (mm ²)	Ölçüler / Dimensions (mm)						Delik Çapı Hole Dia.	Amb. Mik. Pack. Qty. (Adet/Pcs.)	Birim Fiyatı Unit Price (TL/Adet)
			d	d1	d2	l	a	b			
8029320500	CCL-E 16 mm² M6	16	6,5	5,5	7	32,5	11	10,5	M6	500	25,30
8029320510	CCL-E 16 mm² M8	16	8,5	5,5	7	32,5	11	13	M8	500	28,62
8029320520	CCL-E 25 mm² M8	25	8,5	7	9	38,5	16	13	M8	300	37,95
8029320530	CCL-E 35 mm² M8	35	8,5	8,5	10,5	43,5	19	15,5	M8	200	49,76
8029320540	CCL-E 50 mm² M10	50	10,5	10	12	51,5	21	17,6	M10	125	78,79
8029320550	CCL-E 70 mm² M10	70	10,5	11,5	14	55,5	23	20,7	M10	100	122,34
8029320560	CCL-E 95 mm² M12	95	13	13,5	16	58,5	26	23,5	M12	75	147,22
8029320570	CCL-E 120 mm² M12	120	13	15,5	18	71	29	26,7	M12	50	217,72
8029320580	CCL-E 150 mm² M12	150	13	16,5	20	76	30	29,2	M12	30	342,13
8029320590	CCL-E 185 mm² M16	185	17	18,5	22	82	33	32,3	M16	25	387,74
8029320600	CCL-E 240 mm² M16	240	17	21,5	25,5	91	38	37,6	M16	20	597,17

Malzeme : EN 13600 Standardında elektrolitik bakır
Kaplama : Minimum 3 mikron (µm) Kalay Kaplama

Material : EN 13600 Standarts Electrolytically Tin (E-Cu) Plated Copper
Plating : Minimum 3 microns (µm) Tin Plated



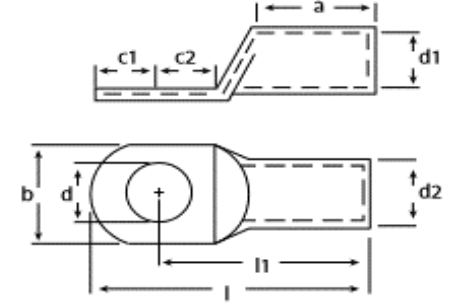

Standart Seri Sıkmalı Kablo Pabuçları

Standart Range Compression Lugs

Ürün Kodu Product Code	Ürün Adı Product Name	Kesit Cross Sec. (mm ²)	Ölçüler / Dimensions (mm)										Delik Çapı Hole Dia.	Amb. Mik. Pack. Qty. (Adet/Pcs.)	Birim Fiyatı Unit Price (TL/Adet)
			d	d1	d2	l	l1	a	b	c1	c2				
8029320610	CCL 10mm² M6	10	6,5	4,4	6	27,5	21,7	10	10,4	6	6	M6	500	23,03	
8029320620	CCL 10mm² M8	10	8,5	4,4	6	27,5	21,7	10	13,7	6	6	M8	500	23,85	
8029320630	CCL 16mm² M6	16	6,5	5,5	8	32,6	24,9	12	11,4	7	8	M6	300	42,51	
8029320640	CCL 16mm² M8	16	8,5	5,5	8	32,6	24,9	12	13,9	7	8	M8	300	39,61	
8029320641	CCL 16mm ² M10	16	10,5	5,5	8	32,6	24,9	12	16,1	7	8	M10	300	40,44	
8029320649	CCL 25mm ² M6	25	6,5	6,8	9	39	32,3	16	13,6	6,8	9,2	M6	200	64,90	
8029320650	CCL 25mm² M8	25	8,5	6,8	9	39	32,3	16	13,7	6,8	9,2	M8	200	63,45	
8029320651	CCL 25mm ² M10	25	10,5	7	9,5	42	34,1	16	16,1	6,8	11	M10	200	62,21	
8029320659	CCL 35mm ² M6	35	6,5	8,2	11	44	35,6	19	15,9	8,3	9,7	M6	150	86,06	
8029320660	CCL 35mm² M8	35	8,5	8,2	11	44	35,6	19	15,9	8,3	9,7	M8	150	86,06	
8029320661	CCL 35mm ² M10	35	10,5	8,2	11	48	37,9	19	15,8	10	12	M10	150	82,94	
8029320669	CCL 50mm ² M8	50	8,5	9,5	12	47,5	39,3	21	17,8	8,3	9,7	M8	100	139,35	
8029320670	CCL 50mm² M10	50	10,5	9,5	12	51,5	41,6	21	17,9	10	12	M10	100	143,07	
8029320671	CCL 50mm ² M12	50	13	10,1	13	51,5	41,6	21	19,2	10	12	M12	100	143,07	
8029320672	CCL 50mm ² M14	50	15	10,1	13	56,5	44,6	21	20,7	12	15	M14	100	170,87	
8029320679	CCL 70mm ² M8	70	8,5	11,2	14,5	54,6	44,5	23	21,2	10	12	M8	75	203,20	
8029320680	CCL 70mm² M10	70	10,5	11,2	14,5	54,6	44,5	23	21,2	10	12	M10	75	192,84	
8029320681	CCL 70mm ² M12	70	13	11,2	14,5	54,6	44,5	23	21,3	10	12	M12	75	184,54	
8029320682	CCL 70mm ² M14	70	15	11,2	14,5	62,6	47,5	23	21,5	15	15	M14	75	232,23	
8029320689	CCL 95mm ² M8	95	8,5	13,4	17	58,8	48,9	26	24,7	10	12	M8	50	245,72	
8029320690	CCL 95mm² M10	95	10,5	13,4	17	58,8	48,9	26	24,7	10	12	M10	50	240,53	
8029320700	CCL 95mm² M12	95	13	13,4	17	58,8	48,9	26	24,6	10	12	M12	50	233,28	
8029320709	CCL 120mm ² M10	120	10,5	15,5	19	69	55,9	29	28,1	13	14,5	M10	40	360,79	
8029320710	CCL 120mm² M12	120	13	15,5	19	69	55,9	29	28,2	13	14,5	M12	40	326,58	
8029320711	CCL 120mm ² M16	120	17	15,5	19	69	55,9	29	28,2	13	14,5	M16	40	326,58	
8029320719	CCL 150mm ² M10	150	10,5	16,5	16,5	76,5	59,9	30	30,2	16,5	16,5	M10	30	508,01	
8029320720	CCL 150mm² M12	150	13	16,5	21	76,5	59,9	30	30,1	16,5	16,5	M12	30	501,79	
8029320721	CCL 150mm ² M16	150	17	16,5	21	76,5	59,9	30	30,1	16,5	16,5	M16	30	497,64	
8029320729	CCL 185mm ² M12	185	13	18,5	23	82,5	65,6	33	34,2	17	18	M12	25	590,95	
8029320730	CCL 185mm² M16	185	17	18,5	23	82,5	65,6	33	34,1	17	18	M16	25	563,99	
8029320739	CCL 240mm ² M12	240	13	21	26	89	72,1	38	38,2	17	18	M12	20	798,30	
8029320740	CCL 240mm² M16	240	17	21	26	89	72,1	38	38,2	17	18	M16	20	787,93	

Malzeme : EN 13600 Standardında elektrolitik bakır
Kaplama : Minimum 3 mikron (µm) Kalay Kaplama

Material : EN 13600 Standarts Electrolytically Tin (E-Cu) Plated Copper
Plating : Minimum 3 microns (µm) Tin Plated

** Koyu renk ile işaretlenmiş kablo pabuçları standart ürünlerimiz olup, diğer kalemler için lütfen stok durumunu sorunuz.

** **Bold colored Lugs items are our standart sizes, pls advise for other items stocks availability**

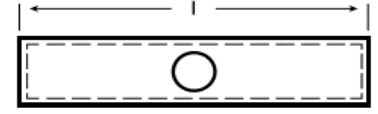

Eko Seri Ek Muflar

Economical Range Compression Butt Terminals

Ürün Kodu Product Code	Ürün Adı Product Name	Kesit Cross Sec. (mm ²)	Uzunluk Length (l) mm	Amb. Mik. Pack. Qty. (Adet/Pcs.)	Birim Fiyatı Unit Price (TL/Adet)
8029320750	CBT-E 16 mm ²	16	32	300	27,58
8029320760	CBT-E 25 mm ²	25	41	200	45,01
8029320770	CBT-E 35 mm ²	35	46	150	58,68
8029320780	CBT-E 50 mm ²	50	54	125	82,94
8029320790	CBT-E 70 mm ²	70	58	100	131,47
8029320800	CBT-E 95 mm ²	95	62	60	156,98
8029320810	CBT-E 120 mm ²	120	74	40	226,43
8029320820	CBT-E 150 mm ²	150	80	30	357,69
8029320830	CBT-E 185 mm ²	185	86	22	415,54
8029320840	CBT-E 240 mm ²	240	95	15	600,29

Malzeme : EN 13600 Standardında elektrolitik bakır
Kaplama : Minimum 3 mikron (µm) Kalay Kaplama

Material : EN 13600 Standarts Electrolytically Tin (E-Cu) Plated Copper
Plating : Minimum 3 microns (µm) Tin Plated

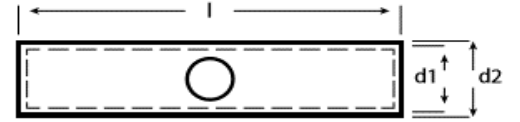

Standart Seri Ek Muflar

Standard Range Compression Butt Terminals

Ürün Kodu Product Code	Ürün Adı Product Name	Kesit Cross Sec. (mm ²)	Ölçüler / Dimensions (mm)			Amb. Mik. Pack. Qty. (Adet/Pcs.)	Birim Fiyatı Unit Price (TL/Adet)
			d1	d2	l		
8029320845	CBT 10 mm ²	10	4,4	6	27	400	27,58
8029320850	CBT 16 mm ²	16	5,5	8	32	250	46,86
8029320860	CBT 25 mm ²	25	7	9	40,5	200	69,47
8029320870	CBT 35 mm ²	35	8,2	11	45,5	150	124,41
8029320880	CBT 50 mm ²	50	9,5	13	53,5	80	165,88
8029320890	CBT 70 mm ²	70	11,2	14,5	57,5	60	234,31
8029320900	CBT 95 mm ²	95	13,4	17	61,5	40	302,73
8029320910	CBT 120 mm ²	120	15	19,5	74	30	414,70
8029320920	CBT 150 mm ²	150	16,5	21	79	25	646,93
8029320930	CBT 185 mm ²	185	19	24	85	18	704,99
8029320940	CBT 240 mm ²	240	21	26	95	13	933,08

Malzeme : EN 13600 Standardında elektrolitik bakır
Kaplama : Minimum 3 mikron (µm) Kalay Kaplama

Material : EN 13600 Standarts Electrolytically Tin (E-Cu) Plated Copper
Plating : Minimum 3 microns (µm) Tin Plated



Malzeme: Bakır, Kalay Kaplı
Material: Copper, Tin Plated
İzolasyon / Isolation PA66

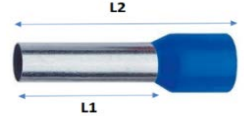

İzoleli Kablo Yüksükleri

Insulated End Sleeves

Ürün Kodu Product Code	Ürün Adı Product Name	Ölçüler Dimensions (mm)		Kesit Cross Sect. (mm ²)	AWG	Norm	Amb. Mik. Pack. Qty (Adet/Pcs.)	Birim Fiyatı Unit Price (TL/Adet)
		L1	L2					
8017335000	IES 0,50/8 Turuncu / Orange	8	12	0,5	20	Alman / German	1.000	0,90
8017335010	IES 0,75/8 Beyaz / White	8	14	0,75	18	Alman / German	1.000	0,90
8017335020	IES 1,0/8 Sarı / Yellow	8	14	1	17	Alman / German	1.000	0,95
8017335030	IES 1,5/8 Kırmızı / Red	8	14	1,5	16	Alman / German	1.000	1,02
8017335040	IES 2,5/8 Mavi / Blue	8	14	2,5	14	Alman / German	500	1,29
8017335050	IES 4,0/10 Gri / Grey	10	17	4	12	Alman / German	500	2,15
8017335060	IES 6,0/12 Siyah / Black	12	20	6	10	Alman / German	250	2,87
8017335070	IES 10,0/12 Fildişi / Ivory	12	22	10	8	Alman / German	100	4,00
8017335080	IES 16,0/12 Yeşil / Green	12	24	16	6	Alman / German	100	5,10
8017335090	IES 25,0/16 Kahve / Brown	16	28	25	4	Alman / German	50	9,53
8017335100	IES 35,0/16 Bej / Beige	16	30	35	2	Alman / German	50	11,08
8017335110	IES 50,0/20 Zeytin Yeşili / Olive Green	20	36	50	1	Alman / German	25	22,13

Ürün Kodu Product Code	Ürün Adı Product Name	Ölçüler Dimensions (mm)		Kesit Cross Sect. (mm ²)	AWG	Norm	Amb. Mik. Pack. Qty (Adet/Pcs.)	Birim Fiyatı Unit Price (TL/Adet)
		L1	L2					
8017335005	IES 0,50/8 Beyaz / White	8	12	0,5	20	Fransız / French	1.000	0,90
8017335015	IES 0,75/8 Mavi / Blue	8	14	0,75	18	Fransız / French	1.000	0,90
8017335025	IES 1,0/8 Kırmızı / Red	8	14	1	17	Fransız / French	1.000	0,95
8017335035	IES 1,5/8 Siyah / Black	8	14	1,5	16	Fransız / French	1.000	1,02
8017335045	IES 2,5/8 Gri / Grey	8	14	2,5	14	Fransız / French	500	1,29
8017335055	IES 4,0/10 Turuncu / Orange	10	17	4	12	Fransız / French	500	2,15
8017335065	IES 6,0/12 Yeşil / Green	12	20	6	10	Fransız / French	250	2,87
8017335075	IES 10,0/12 Kahve / Brown	12	22	10	8	Fransız / French	100	4,00
8017335085	IES 16,0/12 Bej / Beige	12	24	16	6	Fransız / French	100	5,10
8017335095	IES 25,0/16 Siyah / Black	16	28	25	4	Fransız / French	50	9,53
8017335105	IES 35,0/16 Kırmızı / Red	16	30	35	2	Fransız / French	50	11,08
8017335115	IES 50,0/20 Mavi / Blue	20	36	50	1	Fransız / French	25	22,13





Malzeme: Bakır, Kalay Kaplı
Material: Copper, Tin Plated
İzolasyon / Isolation PA66

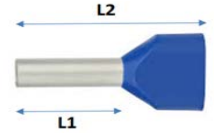

Çift Girişli Kablo Yüksükleri

Twin Cord End Sleeves

Ürün Kodu Product Code	Ürün Adı Product Name	Ölçüler Dimensions (mm)		Kesit Cross Sect. (mm ²)	Norm	Amb. Mik. Pack. Qty (Adet/Pcs.)	Birim Fiyatı Unit Price (TL/Adet)
		L1	L2				
8017335400	IES 2x0,50/8 Turuncu / Orange	8	14	2 x 0,5	Alman / German	1.000	1,64
8017335410	IES 2x0,75/8 Beyaz / White	8	14	2 x 0,75	Alman / German	500	1,69
8017335420	IES 2x1,0/8 Sarı / Yellow	8	14	2 x 1,0	Alman / German	500	1,80
8017335430	IES 2x1,5/8 Kırmızı / Red	8	14	2 x 1,5	Alman / German	500	2,20
8017335440	IES 2x2,5/10 Mavi / Blue	10	14	2 x 2,5	Alman / German	250	3,58
8017335450	IES 2x4,0/12 Gri / Grey	12	17	2 x 4,0	Alman / German	200	4,17
8017335460	IES 2x6,0/14 Siyah / Black	14	20	2 x 6,0	Alman / German	100	5,39
8017335470	IES 2x10,0/14 Fildişi / Ivory	14	27	2 x 10	Alman / German	50	8,25
8017335480	IES 2x16,0/14 Yeşil / Green	14	31	2 x 16	Alman / German	50	11,41

Ürün Kodu Product Code	Ürün Adı Product Name	Ölçüler Dimensions (mm)		Kesit Cross Sect. (mm ²)	Norm	Amb. Mik. Pack. Qty (Adet/Pcs.)	Birim Fiyatı Unit Price (TL/Adet)
		L1	L2				
8017335405	IES 2x0,50/8 Beyaz / White	8	14	2 x 0,5	Fransız / French	1.000	1,64
8017335415	IES 2x0,75/8 Mavi / Blue	8	14	2 x 0,75	Fransız / French	500	1,69
8017335425	IES 2x1,0/8 Kırmızı / Red	8	14	2 x 1,0	Fransız / French	500	1,80
8017335435	IES 2x1,5/8 Siyah / Black	8	14	2 x 1,5	Fransız / French	500	2,20
8017335445	IES 2x2,5/10 Gri / Grey	10	14	2 x 2,5	Fransız / French	250	3,58
8017335455	IES 2x4,0/12 Turuncu / Orange	12	17	2 x 4,0	Fransız / French	200	4,17
8017335465	IES 2x6,0/14 Yeşil / Green	14	20	2 x 6,0	Fransız / French	100	5,39
8017335475	IES 2x10,0/14 Kahve / Brown	14	27	2 x 10	Fransız / French	50	8,25
8017335485	IES 2x16,0/14 Bej / Beige	14	31	2 x 16	Fransız / French	50	11,41



Malzeme: Bakır, Kalay Kaplı
Material: Copper, Tin Plated

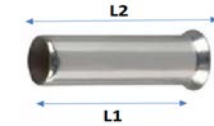

İzolesiz Kablo Yüksükleri

Non-insulated End Sleeves

Ürün Kodu Product Code	Ürün Adı Product Name	Ölçüler Dimensions (mm)		Kesit Cross Sect. (mm ²)	AWG	Amb. Mik. Pack. Qty (Adet/Pcs.)	Birim Fiyatı Unit Price (TL/Adet)
		L1	L2				
8017335220	ES 0,50/10	8	10	0,50	20	2.000	0,95
8017335230	ES 0,75/10	8	10	0,75	18	2.000	0,95
8017335240	ES 1,0/10	8	10	1,00	17	2.000	1,53
8017335250	ES 1,5/10	8	10	1,50	15	2.000	1,02
8017335260	ES 2,5/12	8	12	2,50	13	2.000	2,05
8017335270	ES 4,0/12	10	12	4,00	11	1.000	1,88
8017335280	ES 6,0/12	10	12	6,00	9	500	2,56
8017335290	ES 10,0/15	12	15	10,00	7	200	4,20
8017335300	ES 16,0/15	12	15	16,00	5	200	5,29
8017335310	ES 25,0/16	16	16	25,00	4	100	8,09
8017335320	ES 35,0/16	16	16	35,00	2	100	9,10
8017335330	ES 50,0/20	20	20	50,00	1	50	18,74



Malzeme: Bakır, Nikel Kaplı
Material: Copper, Nickel Plated
İzolasyon / Isolation PVC

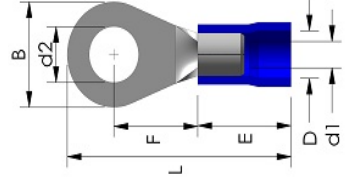

Yuvarlak Pabuçlar

Insulated Ring Terminals

Ürün Kodu Product Code	Ürün Adı Product Name	Kesit Cross Sect. (mm ²)	Ölçüler Dimensions (mm)							Renk Color	Amb. Mik. Pack. Qty (Adet/Pcs.)	Birim Fiyatı Unit Price (TL/Adet)
			d2	B	F	L	E	D	d1			
8018335500	IRT 301	0,5 - 1,5	3,2	5,5	4	16,7	10	4,1	1,7	Kırmızı / Red	200	2,88
8018335510	IRT 351	0,5 - 1,5	3,7	5,5	4	16,7	10	4,1	1,7	Kırmızı / Red	200	3,66
8018335520	IRT 401	0,5 - 1,5	4,3	6,6	6,3	19,6	10	4,1	1,7	Kırmızı / Red	200	4,31
8018335530	IRT 501	0,5 - 1,5	5,3	8	7	21	10	4,1	1,7	Kırmızı / Red	200	4,37
8018335540	IRT 601	0,5 - 1,5	6,5	11,6	11,1	26,8	10	4,1	1,7	Kırmızı / Red	200	6,88
8018335550	IRT 801	0,5 - 1,5	8,4	11,6	11,1	26,8	10	4,1	1,7	Kırmızı / Red	200	6,98
8018335560	IRT 302	1,5 - 2,5	3,2	6,4	4,3	17,5	10	4,5	2,3	Mavi / Blue	200	5,44
8018335570	IRT 402	1,5 - 2,5	4,3	6,6	6,3	19,5	10	4,5	2,3	Mavi / Blue	200	5,55
8018335580	IRT 502	1,5 - 2,5	5,3	8,5	7,8	22	10	4,5	2,3	Mavi / Blue	200	5,55
8018335590	IRT 602	1,5 - 2,5	6,5	12	11	27	10	4,5	2,3	Mavi / Blue	200	7,87
8018335600	IRT 802	1,5 - 2,5	8,4	12	11	27	10	4,5	2,3	Mavi / Blue	200	7,94
8018335610	IRT 1002	1,5 - 2,5	10,5	13,6	13,9	30,7	10	4,5	2,3	Mavi / Blue	100	8,06
8018335620	IRT 406	4,0 - 6,0	4,3	7,2	5,9	22	12,5	6,5	3,4	Sarı / Yellow	75	11,47
8018335630	IRT 506	4,0 - 6,0	5,3	9,5	8,3	25,5	12,5	6,5	3,4	Sarı / Yellow	75	11,52
8018335640	IRT 606	4,0 - 6,0	6,5	12	10,5	29	12,5	6,5	3,4	Sarı / Yellow	75	12,83
8018335650	IRT 806	4,0 - 6,0	8,4	15	13,7	33,7	12,5	6,5	3,4	Sarı / Yellow	75	16,59
8018335660	IRT 1006	4,0 - 6,0	10,5	15	13,7	33,7	12,5	6,5	3,4	Sarı / Yellow	75	16,46
8018335670	IRT 1206	4,0 - 6,0	13	19,2	16	38,1	12,5	6,5	3,4	Sarı / Yellow	75	16,83
8018335680	IRT 510	8,0 - 10,0	5,3	12	9,7	32,5	17	8	4,5	Kırmızı / Red	50	20,38
8018335690	IRT 610	8,0 - 10,0	6,7	12	9,7	32,5	17	8	4,5	Kırmızı / Red	50	22,13



Malzeme: Bakır, Nikel Kaplı
Material: Copper, Nickel Plated
İzolasyon / Isolation PVC

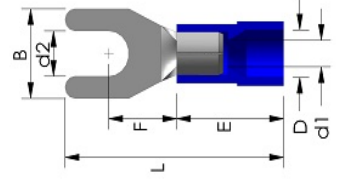

Çatal Pabuçlar

Insulated Fork Terminals

Ürün Kodu Product Code	Ürün Adı Product Name	Kesit Cross Sect. (mm ²)	Ölçüler Dimensions (mm)							Renk Color	Amb. Mik. Pack. Qty (Adet/Pcs.)	Birim Fiyatı Unit Price (TL/Adet)
			d2	B	F	L	E	D	d1			
8018335700	IFT 301	0,5 - 1,5	3,2	5,8	6,3	21	10	4,1	1,7	Kırmızı / Red	200	3,86
8018335720	IFT 401	0,5 - 1,5	4,3	6,4	6,3	20,6	10	4,1	1,7	Kırmızı / Red	200	4,01
8018335730	IFT 501	0,5 - 1,5	5,3	8	7	21	10	4,1	1,7	Kırmızı / Red	200	4,17
8018335740	IFT 601	0,5 - 1,5	6,5	12	11	27,2	10	4,1	1,7	Kırmızı / Red	200	4,71
8018335750	IFT 302	1,5 - 2,5	3,2	5,8	6,3	21	10	4,2	2,3	Mavi / Blue	200	4,26
8018335760	IFT 402	1,5 - 2,5	4,3	6,4	6,3	21	10	4,2	2,3	Mavi / Blue	200	4,42
8018335770	IFT 502	1,5 - 2,5	5,3	9,5	7,2	22	10	4,2	2,3	Mavi / Blue	200	4,42
8018335780	IFT 602	1,5 - 2,5	6,5	12	11	27,2	10	4,2	2,3	Mavi / Blue	200	5,95
8018335790	IFT 406	4,0 - 6,0	4,3	8,5	7,5	25,2	12,5	6,5	3,4	Sarı / Yellow	75	9,81
8018335800	IFT 506	4,0 - 6,0	5,3	9,5	7,5	25,2	12,5	6,5	3,4	Sarı / Yellow	75	10,00
8018335810	IFT 606	4,0 - 6,0	6,5	9,5	7,5	25,2	12,5	6,5	3,4	Sarı / Yellow	75	13,53
8018335820	IFT 806	4,0 - 6,0	8,4	13,5	10,5	30	12,5	6,5	3,4	Sarı / Yellow	75	15,25



Malzeme: Bakır, Pirinç Kaplı
Material: Copper, Brass Plated
İzolasyon / Isolation PVC

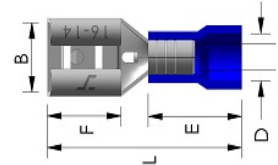

Faston Dişi Pabuçlar

Fast-on Female Terminals

Ürün Kodu Product Code	Ürün Adı Product Name	Kesit Cross Sect. (mm ²)	Ölçüler Dimensions (mm)					Renk Color	Amb. Mik. Pack. Qty (Adet/Pcs.)	Birim Fiyatı Unit Price (TL/Adet)
			B	F	L	E	D			
8018336030	FFT 1288	0,5 - 1,5	3,2	6,4	18,8	10	3,5	Kırmızı / Red	200	3,02
8018336100	FFT 1488	0,5 - 1,5	5	6,4	19,2	10	3,5	Kırmızı / Red	200	3,78
8018336110	FFT 1638	0,5 - 1,5	6,6	7,2	20,8	10	3,5	Kırmızı / Red	200	4,88
8018336115	FFT 2288	1,5 - 2,5	5	6,4	19,2	10	4,2	Mavi / Blue	150	3,78
8018336120	FFT 2488	1,5 - 2,5	6,6	6,4	19,2	10	4,2	Mavi / Blue	150	4,32
8018336130	FFT 2638	1,5 - 2,5	6,6	7,2	20,8	10	4,2	Mavi / Blue	150	4,99
8018336140	FFT 5638	4,0 - 6,0	6,6	7,2	23,3	13	5,6	Sarı / Yellow	100	6,00



Malzeme: Bakır, Pirinç Kaplı
Material: Copper, Brass Plated
İzolasyon / Isolation PVC

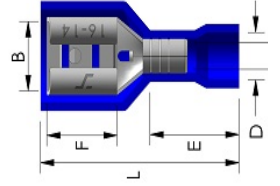

İzoleli Faston Dişi Pabuçlar

Insulated Fast-on Female Terminals

Ürün Kodu Product Code	Ürün Adı Product Name	Kesit Cross Sect. (mm ²)	Ölçüler Dimensions (mm)					Renk Color	Amb. Mik. Pack. Qty (Adet/Pcs.)	Birim Fiyatı Unit Price (TL/Adet)
			B	F	L	E	D			
8018336300	IFFT 1288	0,5 - 1,5	3,2	6,4	18,8	10	3,5	Kırmızı / Red	200	4,56
8018336310	IFFT 1488	0,5 - 1,5	5	6,4	19,2	10	3,5	Kırmızı / Red	200	4,99
8018336320	IFFT 1638	0,5 - 1,5	6,6	7,2	20,8	10	3,5	Kırmızı / Red	100	6,54
8018336325	IFFT 2288	1,5 - 2,5	3,2	6,4	20,0	10	4,2	Mavi / Blue	100	4,91
8018336330	IFFT 2488	1,5 - 2,5	5	6,4	19,2	10	4,2	Mavi / Blue	100	4,99
8018336340	IFFT 2638	1,5 - 2,5	6,6	7,2	20,8	10	4,2	Mavi / Blue	100	6,54
8018336350	IFFT 5638	4,0 - 6,0	6,6	7,2	23,8	13	5,6	Sarı / Yellow	75	7,21



Malzeme: Bakır, Pirinç Kaplı
Material: Copper, Brass Plated
İzolasyon / Isolation PVC

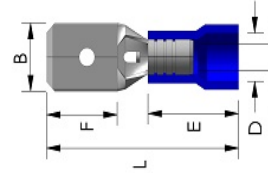

Faston Erkek Pabuçlar

Fast-on Male Terminals

Ürün Kodu Product Code	Ürün Adı Product Name	Kesit Cross Sect. (mm ²)	Ölçüler Dimensions (mm)					Renk Color	Amb. Mik. Pack. Qty (Adet/Pcs.)	Birim Fiyatı Unit Price (TL/Adet)
			B	F	L	E	D			
8018336150	FMT 1288	0,5 - 1,5	2,8	6,5	18,7	10	3,5	Kırmızı / Red	200	3,44
8018336160	FMT 1488	0,5 - 1,5	4,8	6,7	19,3	10	3,5	Kırmızı / Red	200	3,47
8018336170	FMT 1638	0,5 - 1,5	6,3	7,7	20,8	10	3,5	Kırmızı / Red	1200	4,11
8018336175	FMT 2288	1,5 - 2,5	2,8	6,7	19,3	10	4,2	Mavi / Blue	200	3,49
8018336180	FMT 2488	1,5 - 2,5	4,8	6,7	19,3	10	4,2	Mavi / Blue	200	3,49
8018336190	FMT 2638	1,5 - 2,5	6,3	7,7	20,8	10	4,2	Mavi / Blue	200	4,43
8018336200	FMT 5638	4,0 - 6,0	6,3	7,7	24	13	5,6	Sarı / Yellow	100	5,55



Malzeme: Bakır, Kalay Kaplı
Material: Copper, Tin Plated
İzolasyon / Isolation PVC

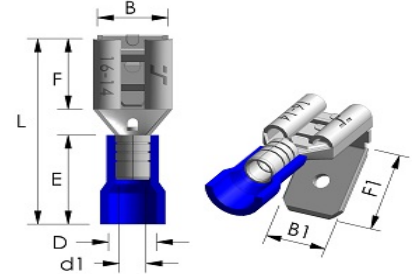

Geri Dönüştü Pabuçlar

Piggy Back Terminals

Ürün Kodu Product Code	Ürün Adı Product Name	Kesit Cross Sect. (mm ²)	Ölçüler Dimensions (mm)								Renk Color	Amb. Mik. Pack. Qty (Adet/Pcs.)	Birim Fiyatı Unit Price (TL/Adet)
			B	B1	F	F1	L	E	D	d1			
8018336460	PBT 1638	0,5 - 1,5	6,6	6,3	8	8,2	22	10	3,5	1,7	Kırmızı / Red	100	8,43
8018336470	PBT 2638	1,5 - 2,5	6,6	6,3	8	8,2	22	10	4,2	2,3	Mavi / Blue	100	8,65
8018336480	PBT 5638	4,0 - 6,0	6,6	6,3	8	8,2	25	13	5,6	3,4	Sarı / Yellow	100	9,53



Malzeme: Bakır, Kalay Kaplı
Material: Copper, Tin Plated
İzolasyon / Isolation PVC

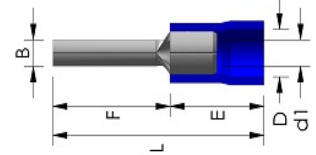

İğne Tip Pabuçlar

Insulated Pin Terminals

Ürün Kodu Product Code	Ürün Adı Product Name	Kesit Cross Sect. (mm ²)	Ölçüler Dimensions (mm)						Renk Color	Amb. Mik. Pack. Qty (Adet/Pcs.)	Birim Fiyatı Unit Price (TL/Adet)
			B	F	L	E	D	d1			
8018335900	IPT 1/1,5	0,5 - 1,5	1,9	12	22	10	4,3	1,7	Kırmızı / Red	200	4,56
8018335910	IPT 1/2,5	1,5 - 2,5	1,9	12	22	10	4,8	2,3	Mavi / Blue	200	5,44
8018335920	IPT 1/6	4,0 - 6,0	2,8	14	28	13	6,2	3,4	Sarı / Yellow	100	12,76



Malzeme: Bakır, Pirinç Kaplı
Material: Copper, Brass Plated
İzolasyon / Isolation PVC

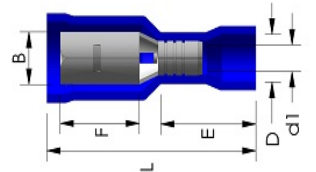

Dişi Pabuçlar

Bullet Female Terminals

Ürün Kodu Product Code	Ürün Adı Product Name	Kesit Cross Sect. (mm ²)	Ölçüler Dimensions (mm)						Renk Color	Amb. Mik. Pack. Qty (Adet/Pcs.)	Birim Fiyatı Unit Price (TL/Adet)
			B	F	L	E	D	d1			
8018336600	BFT 1040	0,5 - 1,5	3,9	7,3	23,5	10	3,5	1,7	Kırmızı / Red	100	11,87
8018336610	BFT 2050	1,5 - 2,5	4,9	8,5	25	10	4,2	2,3	Mavi / Blue	100	13,08
8018336620	BFT 5050	4,0 - 6,0	4,9	8,5	28	13	5,6	3,4	Sarı / Yellow	50	16,63



Malzeme: Bakır, Pirinç Kaplı
Material: Copper, Brass Plated
İzolasyon / Isolation PVC

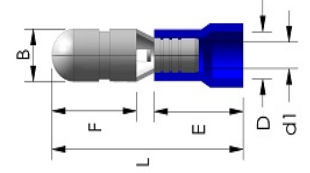

Erkek Pabuçlar

Bullet Male Terminals

Ürün Kodu Product Code	Ürün Adı Product Name	Kesit Cross Sect. (mm ²)	Ölçüler Dimensions (mm)						Renk Color	Amb. Mik. Pack. Qty (Adet/Pcs.)	Birim Fiyatı Unit Price (TL/Adet)
			B	F	L	E	D	d1			
8018336700	BMT 1040	0,5 - 1,5	4	8,5	21	10	3,5	1,7	Kırmızı / Red	100	9,98
8018336710	BMT 2050	1,5 - 2,5	5	9	21,5	10	4,2	2,3	Mavi / Blue	100	11,08
8018336720	BMT 5050	4,0 - 6,0	5	9	24,5	13	5,6	3,4	Sarı / Yellow	100	15,08



Malzeme: Bakır, Kalay Kaplı
Material: Copper, Tin Plated
İzolasyon / Isolation PVC

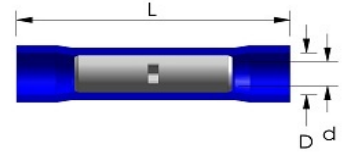

Ek Muflar

Insulated Butt Terminals

Ürün Kodu Product Code	Ürün Adı Product Name	Kesit Cross Sect. (mm ²)	Ölçüler Dimensions (mm)			Renk Color	Amb. Mik. Pack. Qty (Adet/Pcs.)	Birim Fiyatı Unit Price (TL/Adet)
			L	D	d			
8018336500	IBT 251	0,5 - 1,5	24,5	4,3	1,7	Kırmızı / Red	100	6,54
8018336510	IBT 252	1,5 - 2,5	24,5	4,8	2,3	Mavi / Blue	100	6,77
8018336520	IBT 256	4,0 - 6,0	27	6,2	3,4	Sarı / Yellow	100	10,97

Ledli Sinyal Lambaları - Ø22 mm

LED Indicators - Ø22 mm



Ürün Kodu Product Code	Ürün Adı Product Name		Nominal Gerilim Nominal Voltage (V)	Renk Color	Amb. Mik. Pack. Qty (Adet/Pcs.)	Birim Fiyatı Unit Price (TL/Adet)
8026088912	SIL-X22-220 AC Kırmızı	SIL22-220 Red Signal Lamp with LED	220V AC	●	25	97,81
8026088914	SIL-X22-220 AC Sarı	SIL22-220 Green Signal Lamp with LED	220V AC	●	25	97,81
8026088915	SIL-X22-220 AC Yeşil	SIL22-220 Yellow Signal Lamp with LED	220V AC	●	25	97,81
8026088916	SIL-X22-220 AC Mavi	SIL22-220 Blue Signal Lamp with LED	220V AC	●	25	97,81
8026088919	SIL-X22-220 AC Beyaz	SIL22-220 White Signal Lamp with LED	220V AC	○	25	97,81
8026088922	SIL-X22-220 AC/DC Kırmızı	SIL22-220DC Red Signal Lamp with LED	220V DC	●	25	97,81
8026088924	SIL-X22-220 AC/DC Sarı	SIL22-220DC Green Signal Lamp with LED	220V DC	●	25	97,81
8026088925	SIL-X22-220 AC/DC Yeşil	SIL22-220DC Yellow Signal Lamp with LED	220V DC	●	25	97,81
8026088926	SIL-X22-220 AC/DC Mavi	SIL22-220DC Blue Signal Lamp with LED	220V DC	●	25	97,81
8026088929	SIL-X22-220 AC/DC Beyaz	SIL22-220DC White Signal Lamp with LED	220V DC	○	25	97,81

Ledli Sinyal Lambaları - Ø22 mm

LED Indicators - Ø22 mm

Ürün Kodu Product Code	Ürün Adı Product Name	Nominal Gerilim Nominal Voltage (V)	Renk Color	Amb. Mik. Pack. Qty (Adet/Pcs.)	Birim Fiyatı Unit Price (TL/Adet)
8026088912	SIL-X22-220 AC	220V AC	●	25	97,81
8026088914	SIL-X22-220 AC	220V AC	●	25	97,81
8026088915	SIL-X22-220 AC	220V AC	●	25	97,81
8026088916	SIL-X22-220 AC	220V AC	●	25	97,81
8026088919	SIL-X22-220 AC	220V AC	○	25	97,81
8026088922	SIL-X22-220 AC/DC	220V DC	●	25	97,81
8026088924	SIL-X22-220 AC/DC	220V DC	●	25	97,81
8026088925	SIL-X22-220 AC/DC	220V DC	●	25	97,81
8026088926	SIL-X22-220 AC/DC	220V DC	●	25	97,81
8026088929	SIL-X22-220 AC/DC	220V DC	○	25	97,81

Sinyal Lambası
Ledli
Signal Lamp
with LED

YENİ ÜRÜN
NEW PRODUCT

8026078912	SIL22-220 Kırmızı Sinyal Lambası Ledli	SIL22-220 Red Signal Lamp with LED	220V AC	●	25	97,81
8026078915	SIL22-220 Yeşil Sinyal Lambası Ledli	SIL22-220 Green Signal Lamp with LED	220V AC	●	25	97,81
8026078914	SIL22-220 Sarı Sinyal Lambası Ledli	SIL22-220 Yellow Signal Lamp with LED	220V AC	●	25	97,81
8026078916	SIL22-220 Mavi Sinyal Lambası Ledli	SIL22-220 Blue Signal Lamp with LED	220V AC	●	25	100,39
8026078919	SIL22-220 Beyaz Sinyal Lambası Ledli	SIL22-220 White Signal Lamp with LED	220V AC	○	25	100,39
8026078922	SIL22-220DC Kırmızı Sinyal Lambası Ledli	SIL22-220DC Red Signal Lamp with LED	220V DC	●	25	97,81
8026078925	SIL22-220DC Yeşil Sinyal Lambası Ledli	SIL22-220DC Green Signal Lamp with LED	220V DC	●	25	97,81
8026078924	SIL22-220DC Sarı Sinyal Lambası Ledli	SIL22-220DC Yellow Signal Lamp with LED	220V DC	●	25	97,81
8026078926	SIL22-220DC Mavi Sinyal Lambası Ledli	SIL22-220DC Blue Signal Lamp with LED	220V DC	●	25	100,39
8026078929	SIL22-220DC Beyaz Sinyal Lambası Ledli	SIL22-220DC White Signal Lamp with LED	220V DC	○	25	100,39
8026078932	SIL22-110 Kırmızı Sinyal Lambası Ledli	SIL22-110 Red Signal Lamp with LED	110V AC/DC	●	25	97,81
8026078935	SIL22-110 Yeşil Sinyal Lambası Ledli	SIL22-110 Green Signal Lamp with LED	110V AC/DC	●	25	97,81
8026078934	SIL22-110 Sarı Sinyal Lambası Ledli	SIL22-110 Yellow Signal Lamp with LED	110V AC/DC	●	25	97,81
8026078936	SIL22-110 Mavi Sinyal Lambası Ledli	SIL22-110 Blue Signal Lamp with LED	110V AC/DC	●	25	100,39
8026078939	SIL22-110 Beyaz Sinyal Lambası Ledli	SIL22-110 White Signal Lamp with LED	110V AC/DC	○	25	100,39
8026078942	SIL22-24 Kırmızı Sinyal Lambası Ledli	SIL22-24 Red Signal Lamp with LED	24V AC/DC	●	25	97,81
8026078945	SIL22-24 Yeşil Sinyal Lambası Ledli	SIL22-24 Green Signal Lamp with LED	24V AC/DC	●	25	97,81
8026078944	SIL22-24 Sarı Sinyal Lambası Ledli	SIL22-24 Yellow Signal Lamp with LED	24V AC/DC	●	25	97,81
8026078946	SIL22-24 Mavi Sinyal Lambası Ledli	SIL22-24 Blue Signal Lamp with LED	24V AC/DC	●	25	100,39
8026078949	SIL22-24 Beyaz Sinyal Lambası Ledli	SIL22-24 White Signal Lamp with LED	24V AC/DC	○	25	100,39

Yaylı Kumanda Butonları - Ø22 mm

Push Buttons Spring Return - Ø22 mm

Ürün Kodu Product Code	Ürün Adı Product Name	Kontakt Contact	Renk Color	Amb. Mik. Pack. Qty (Adet/Pcs.)	Birim Fiyatı Unit Price (TL/Adet)
8025078002	PSR-1C Kırmızı Düz Yaylı Tip 1 NK	PSR-1C Red Spring Return 1 NK	1 NK	15	159,59
8025078075	PSR-10 Yeşil Düz Yaylı Tip 1 NA	PSR-10 Green Spring Return 1 NO	1 NA	15	159,59
8025078104	PSR-10 Sarı Düz Yaylı Tip 1 NA	PSR-10 Yellow Spring Return 1 NO	1 NA	15	159,59
8025078106	PSR-10 Mavi Düz Yaylı Tip 1 NA	PSR-10 Blue Spring Return 1 NO	1 NA	15	159,59
8025078109	PSR-10 Beyaz Düz Yaylı Tip 1 NA	PSR-10 White Spring Return 1 NO	1 NA	15	159,59
8025078100	PSR-10 Siyah Düz Yaylı Tip 1 NA	PSR-10 Black Spring Return 1 NO	1 NA	15	159,59

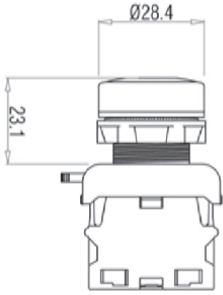

PSR-10 Sarı/Yellow



PSR-1C Kırmızı/Red



PSR-1C Yeşil/Green

Silikon Buton Koruma Kılıfı - Ø22 mm

Button Protection Cover - Ø22 mm

Ürün Kodu Product Code	Ürün Adı Product Name	Amb. Mik. Pack. Qty (Adet/Pcs.)	Birim Fiyatı Unit Price (TL/Adet)	
8025078000	PSR-IP Şeffaf Silikon Buton Koruma Kılıfı	PSR-IP Transparent Button Protection Cover	15	96,10



LED'li Yaylı Kumanda Butonları - Ø 22 mm

Push Buttons Spring Return LED - Ø 22 mm

Ürün Kodu Product Code	Ürün Adı Product Name	Nominal Gerilim (V) Nominal Voltage (V)	Renk Color	Amb. Mik. Pack. Qty (Adet/Pcs.)	Birim Fiyatı Unit Price (TL/Adet)
8025078022	PSRL-1C 220 Kırmızı Düz Yaylı Tip 1 NK Ledli	220 V AC/DC	Red	15	300,30
8025078085	PSRL-1O 220 Yeşil Düz Yaylı Tip 1 NA Ledli	220 V AC/DC	Green	15	300,30
8025078224	PSRL-1O 220 Sarı Düz Yaylı Tip 1 NA Ledli	220 V AC/DC	Yellow	15	300,30
8025078226	PSRL-1O 220 Mavi Düz Yaylı Tip 1 NA Ledli	220 V AC/DC	Blue	15	300,30
8025078229	PSRL-1O 220 Beyaz Düz Yaylı Tip 1 NA Ledli	220 V AC/DC	White	15	300,30
8025078032	PSRL-1C 110 Kırmızı Düz Yaylı Tip 1 NK Ledli	110 V AC/DC	Red	15	300,30
8025078095	PSRL-1O 110 Yeşil Düz Yaylı Tip 1 NA Ledli	110 V AC/DC	Green	15	300,30
8025078234	PSRL-1O 110 Sarı Düz Yaylı Tip 1 NA Ledli	110 V AC/DC	Yellow	15	300,30
8025078236	PSRL-1O 110 Mavi Düz Yaylı Tip 1 NA Ledli	110 V AC/DC	Blue	15	300,30
8025078239	PSRL-1O 110 Beyaz Düz Yaylı Tip 1 NA Ledli	110 V AC/DC	White	15	300,30
8025078042	PSRL-1C 48 Kırmızı Düz Yaylı Tip 1 NK Ledli	48 V AC/DC	Red	15	300,30
8025078205	PSRL-1O 48 Yeşil Düz Yaylı Tip 1 NA Ledli	48 V AC/DC	Green	15	300,30
8025078204	PSRL-1O 48 Sarı Düz Yaylı Tip 1 NA Ledli	48 V AC/DC	Yellow	15	300,30
8025078206	PSRL-1O 48 Mavi Düz Yaylı Tip 1 NA Ledli	48 V AC/DC	Blue	15	300,30
8025078209	PSRL-1O 48 Beyaz Düz Yaylı Tip 1 NA Ledli	48 V AC/DC	White	15	300,30
8025078052	PSRL-1C 24 Kırmızı Düz Yaylı Tip 1 NK Ledli	24 V AC/DC	Red	15	300,30
8025078215	PSRL-1O 24 Yeşil Düz Yaylı Tip 1 NA Ledli	24 V AC/DC	Green	15	300,30
8025078214	PSRL-1O 24 Sarı Düz Yaylı Tip 1 NA Ledli	24 V AC/DC	Yellow	15	300,30
8025078216	PSRL-1O 24 Mavi Düz Yaylı Tip 1 NA Ledli	24 V AC/DC	Blue	15	300,30
8025078219	PSRL-1O 24 Beyaz Düz Yaylı Tip 1 NA Ledli	24 V AC/DC	White	15	300,30

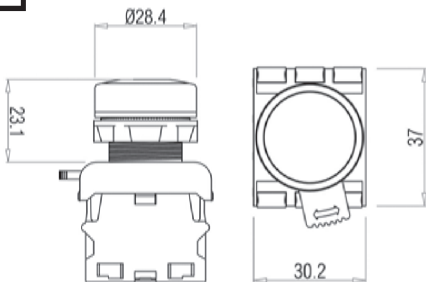

PSRL-1C Kırmızı/Red



PSRL-1O Yeşil/Green



PSRL-1O Mavi/Blue

Çiftli, Yaylı Kumanda Butonları - Ø 22 mm

Double Spring Push Button - Ø22 mm

Ürün Kodu Product Code	Ürün Adı Product Name	Kontakt Contact	Renk Color	Amb. Mik. Pack. Qty (Adet/Pcs.)	Birim Fiyatı Unit Price (TL/Adet)
8025078302	DSR-1C10 Çiftli Yaylı Tip 1NA+1NK	1 NA + 1 NK		10	248,82
8025078312	DSRL-1C10 220 Çiftli Yaylı Tip 1NA+1NK Ledli	1 NA + 1 NK		10	466,54
8025078362	DSRL-1C10 110 Çiftli Yaylı Tip 1NA+1NK Ledli	1 NA + 1 NK		10	386,10
8025078372	DSRL-1C10 24 Çiftli Yaylı Tip 1NA+1NK Ledli	1 NA + 1 NK		10	386,10

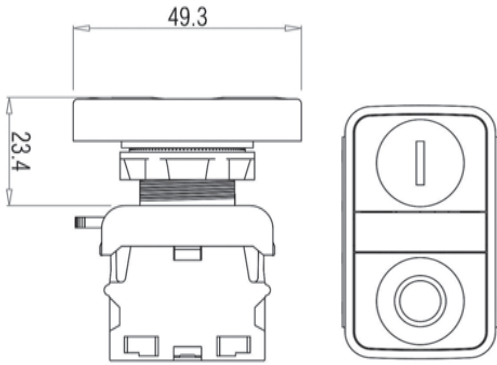

DSR-1C10

Acil Stop Kumanda Butonları - Ø 22 mm

Emergency Stop - Ø 22 mm

Ürün Kodu Product Code	Ürün Adı Product Name	Kontakt Contact	Renk Color	Amb. Mik. Pack. Qty (Adet/Pcs.)	Birim Fiyatı Unit Price (TL/Adet)
8025078012	EPB-1C Acil Stop 1 NK	1NK		10	238,45

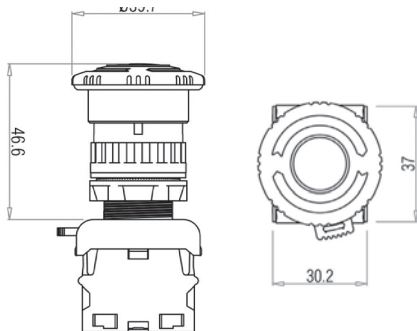

EPB-1C

Kalıcı Tip Seçici Butonlar - Ø 22 mm

Selector Switches Maintained - Ø22 mm

Ürün Kodu Product Code	Ürün Adı Product Name	Kontakt Contac	Renk Color	Pozisyon Position	Amb. Mik. Pack. Qty (Adet/Pcs.)	Birim Fiyatı Unit Price (TL/Adet)
8025078500	SSP-10 Kalıcı 0-1 Seçici Buton	1 NA	●	0 1	12	171,60
8025078510	SSP-20 Kalıcı 1-0-2 Seçici Buton	2 NA	●	1 0 2	12	275,78

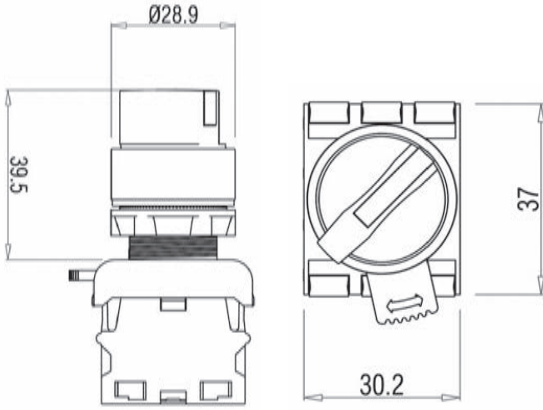

SSP-20

Yay Dönüslü Seçici Butonlar - Ø 22 mm

Selector Switch Momentary - Ø22 mm

Ürün Kodu Product Code	Ürün Adı Product Name	Kontakt Contact	Renk Color	Pozisyon Position	Amb. Mik. Pack. Qty (Adet/Pcs.)	Birim Fiyatı Unit Price (TL/Adet)
8025078320	SSM-10 Yay Dönüslü 0-1 Seçici Buton	1 NA	●	0 1	12	188,76
8025078330	SSM-20 Yay Dönüslü 1-0-2 Seçici Buton	2 NA	●	1 0 2	12	257,40

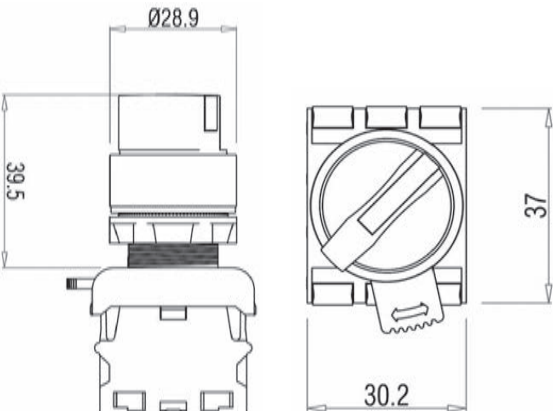

SSM-10

LED'li Kalıcı Tip Seçici Butonlar - Ø 22 mm

Selector Switches Maintained with LED - Ø22 mm

Ürün Kodu Product Code	Ürün Adı Product Name	Nominal Gerilim (V) Nominal Voltage (V)	Renk Color	Pozisyon Position	Amb. Mik. Pack. Qty (Adet/Pcs.)	Birim Fiyatı Unit Price (TL/Adet)
8025078602	SSP-10 220 L Kırmızı Kalıcı Işıklı 0-1 Seçici Buton	220 V AC/DC	Red	0 1	12	326,04
8025078605	SSP-10 220 L Yeşil Kalıcı Işıklı 0-1 Seçici Buton	220 V AC/DC	Green	0 1	12	326,04
8025078604	SSP-10 220 L Sarı Kalıcı Işıklı 0-1 Seçici Buton	220 V AC/DC	Yellow	0 1	12	326,04
8025078622	SSP-20 220 L Kırmızı Kalıcı Işıklı 1-0-2 Seçici Buton	220 V AC/DC	Red	1 0 2	12	386,10
8025078615	SSP-20 220 L Yeşil Kalıcı Işıklı 1-0-2 Seçici Buton	220 V AC/DC	Green	1 0 2	12	386,10
8025078614	SSP-20 220 L Sarı Kalıcı Işıklı 1-0-2 Seçici Buton	220 V AC/DC	Yellow	1 0 2	12	386,10

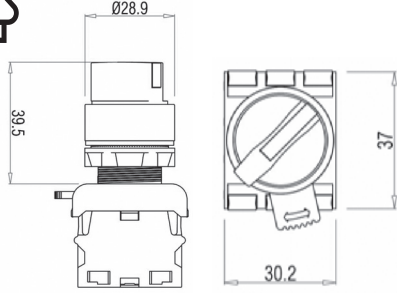

SSP-10 220 L Yeşil/Green



SSP-10 220 L Kırmızı/Red

LED'li Tip Yay Dönüslü Seçici Butonlar - Ø 22 mm

Selector Switch Momentary with LED - Ø22 mm

Ürün Kodu Product Code	Ürün Adı Product Name	Nominal Gerilim (V) Nominal Voltage (V)	Renk Color	Pozisyon Position	Amb. Mik. Pack. Qty (Adet/Pcs.)	Birim Fiyatı Unit Price (TL/Adet)
8025078402	SSM-10 220 L Kırmızı Yay Dönüslü Işıklı 0-1 Seçici Buton	220 V AC/DC	Red	0 1	12	305,45
8025078405	SSM-10 220 L Yeşil Yay Dönüslü Işıklı 0-1 Seçici Buton	220 V AC/DC	Green	0 1	12	305,45
8025078404	SSM-10 220 L Sarı Yay Dönüslü Işıklı 0-1 Seçici Buton	220 V AC/DC	Yellow	0 1	12	305,45
8025078422	SSM-20 220 L Kırmızı Yay Dönüslü Işıklı 1-0-2 Seçici Buton	220 V AC/DC	Red	1 0 2	12	389,53
8025078415	SSM-20 220 L Yeşil Yay Dönüslü Işıklı 1-0-2 Seçici Buton	220 V AC/DC	Green	1 0 2	12	389,53
8025078424	SSM-20 220 L Sarı Yay Dönüslü Işıklı 1-0-2 Seçici Buton	220 V AC/DC	Yellow	1 0 2	12	389,53

LED li Kalıcı ve Yaylı Tip Seçici Butonların 110V AC/DC ve 24V AC/DC Nominal Gerilimleri için lütfen satış temsilcinizle irtibata geçiniz.

Kontakt Blok Tipleri

Contact Block Types

Ürün Kodu Product Code	Ürün Adı Product Name	Kontakt Contact	Amb. Mik. Pack. Qty (Adet/Pcs.)	Birim Fiyatı Unit Price (TL/Adet)	
8025078800	CNT-O NA Kontakt	CNT-O NO Contact	1 NA	50	68,64
8025078810	CNT-C NK Kontakt	CNT-C NC Contact	1 NK	50	68,64
8025078820	CNT-S Işık Kontakt Blok	CNT-S Signal Contact	50		77,22



CNT-O / CNT-C

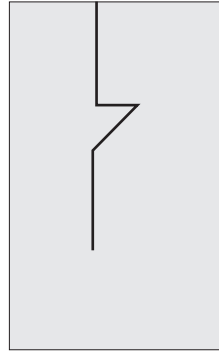

NK/NC
Kontakt/Contact

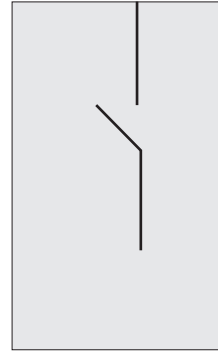

NA/NO
Kontakt/Contact

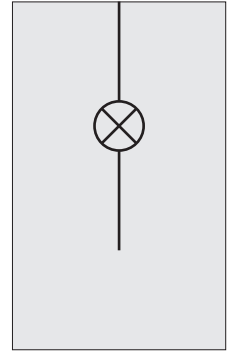

Sinyal Kontakt
Signal Contact



CNT-S



Teknik Bilgiler / Technical Information

Standart / Standard	IEC 60947-5-1
Çalışma Sıcaklığı min/maks. / Operating Temperature min/max (°C)	-5 / +40
Kirlilik Derecesi / Pollution Severity	3
Yalıtım Gerilimi / Rated insulation voltage (V)	400
Darbe Beyan Gerilimi / Rated impulse withstand voltage (kV)	4
Klasik Açık hava Termal Akım / Conventional Thermal Current (A)	10
Kullanım Sınıfı / Utilization Category	AC 15

Nominal Çalışma Gerilimi / Rated Operational Voltage (V)	Nominal Çalışma Akımı / Rated Operational Current (A)
380	1,9
240	3
120	6

ENDÜSTRİYEL ve PLC RÖLELER

İnce Tip Endüstriyel Röle
Kalın Tip Endüstriyel Röle
Vida Bağlantılı PLC Röle

Röle Soketi (Vidalı ve Push-in)
Röle Tutucu, Ekstra Klipsler
Harici Led Modülleri
Markalama

INDUSTRIAL and INTERFACE RELAYS

Compact Industrial Relays
Plug-In Industrial Relays
Screw Type Interface Relay

Relay Socket (Screw and Push-In)
Relay Holder, Support Clips
External Led Modul
Marking

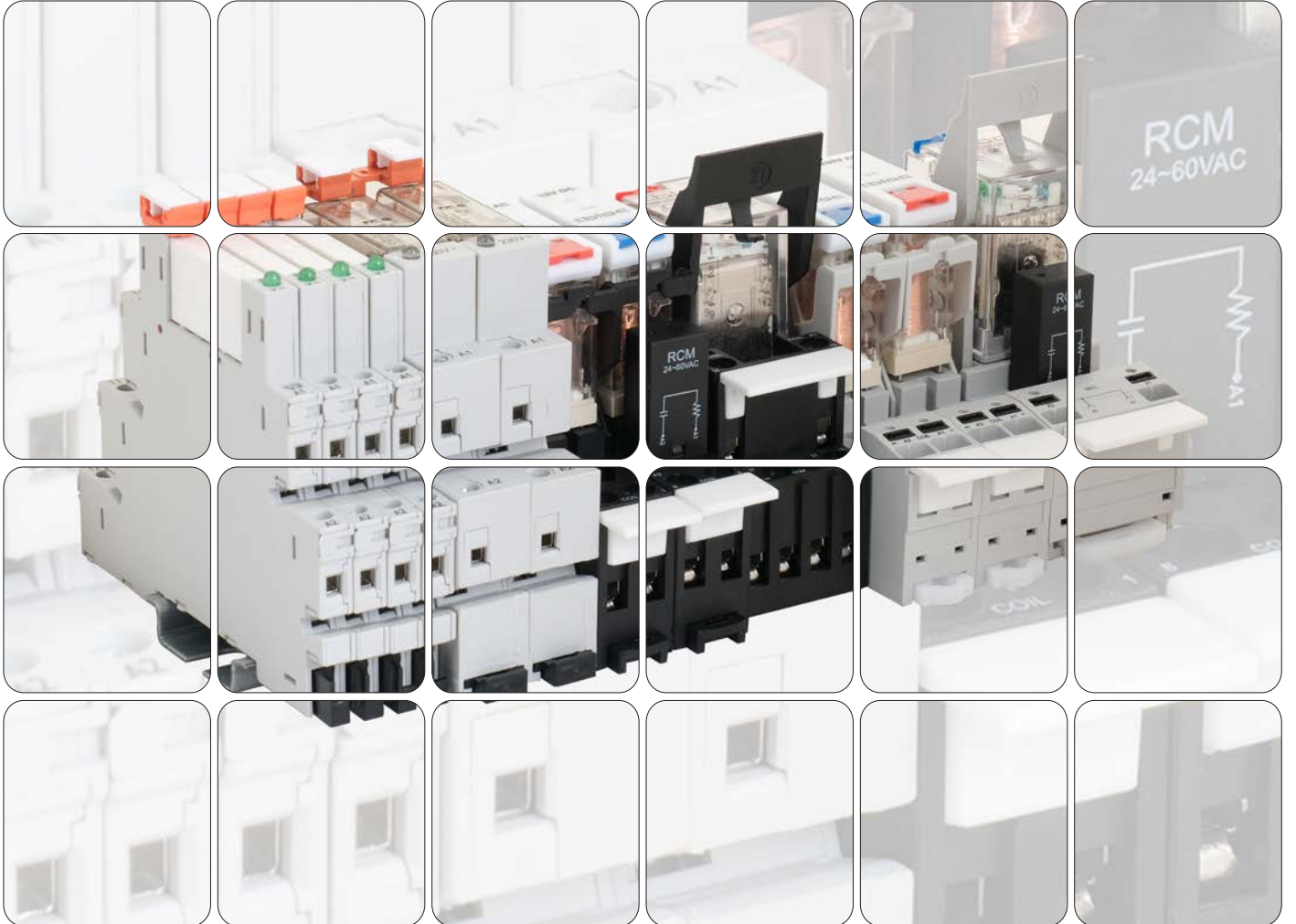

1CO 12A İnce Tip Endüstriyel Röle

Compact Industrial Relay



Ürün Kodu Product Code	Ürün Adı Product Name	Açıklama Explanation	Amb. Mik. Pack. Qty (Adet/Pcs.)	Birim Fiyatı Unit Price (USD/Adet)
8036311200	TRS LT-1C-12A-12 V DC	1CO, 12A, 12V DC, LED+Test Butonlu Kompakt Röle / Test Button Compact Relay	20	7,15
8036311210	TRS LT-1C-12A-24 V DC	1CO, 12A, 24V DC, LED+Test Butonlu Kompakt Röle / Test Button Compact Relay	20	7,15
8036311220	TRS LT-1C-12A-48 V DC	1CO, 12A, 48V DC, LED+Test Butonlu Kompakt Röle / Test Button Compact Relay	20	7,80
8036311230	TRS LT-1C-12A-110 V DC	1CO, 12A, 110V DC, LED+Test Butonlu Kompakt Röle / Test Button Compact Relay	20	9,10
8036311240	TRS LT-1C-12A-24 V AC	1CO, 12A, 24V AC, LED+Test Butonlu Kompakt Röle / Test Button Compact Relay	20	8,45
8036311270	TRS LT-1C-12A-230 V AC	1CO, 12A, 230V AC, LED+Test Butonlu Kompakt Röle / Test Button Compact Relay	20	9,10

2CO 8A İnce Tip Endüstriyel Röle

Compact Industrial Relay



Ürün Kodu Product Code	Ürün Adı Product Name	Açıklama Explanation	Amb. Mik. Pack. Qty (Adet/Pcs.)	Birim Fiyatı Unit Price (USD/Adet)
8036312800	TRS LT-2C-8A-12 V DC	2CO, 8A, 12V DC, LED+Test Butonlu Kompakt Röle / Test Button Compact Relay	20	8,45
8036312810	TRS LT-2C-8A-24 V DC	2CO, 8A, 24V DC, LED+Test Butonlu Kompakt Röle / Test Button Compact Relay	20	7,15
8036312820	TRS LT-2C-8A-48 V DC	2CO, 8A, 48V DC, LED+Test Butonlu Kompakt Röle / Test Button Compact Relay	20	9,10
8036312830	TRS LT-2C-8A-110 V DC	2CO, 8A, 110V DC, LED+Test Butonlu Kompakt Röle / Test Button Compact Relay	20	9,10
8036312840	TRS LT-2C-8A-24 V AC	2CO, 8A, 24V AC, LED+Test Butonlu Kompakt Röle / Test Button Compact Relay	20	8,45
8036312860	TRS LT-2C-8A-115 V AC	2CO, 8A, 115V AC, LED+Test Butonlu Kompakt Röle / Test Button Compact Relay	20	8,45
8036312870	TRS LT-2C-8A-230 V AC	2CO, 8A, 230V AC, LED+Test Butonlu Kompakt Röle / Test Button Compact Relay	20	9,10

Aksesuarlar

Accessories

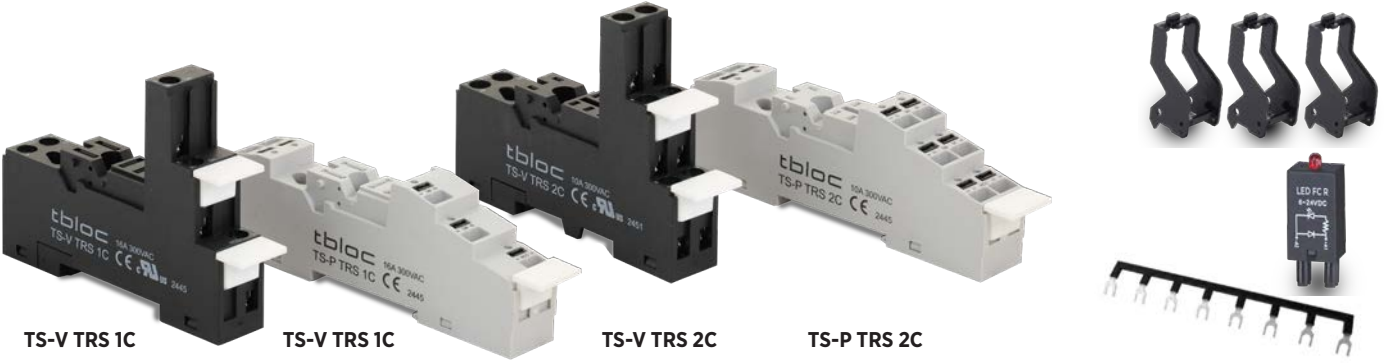

Ürün Kodu Product Code	Ürün Adı Product Name	Açıklama Explanation	Amb. Mik. Pack. Qty (Adet/Pcs.)	Birim Fiyatı Unit Price (USD/Adet)
8036012000	TS-V TRS 1C	1 Kontaklı Vidalı Röle Soketi / 1 Screw Relay Socket	20	5,20
8036012001	TS-V TRS 2C	2 Kontaklı Vidalı Röle Soketi / 2 Screw Relay Socket	20	5,20
8036212000	TS-P TRS 1C	1 Kontaklı Push-In Röle Soketi / 1C Push-In Relay Socket	20	7,80
8036212001	TS-P TRS 2C	2 Kontaklı Push-In Röle Soketi / 2C Push-In Relay Socket	20	7,80
8036330100	MARK- TRS	Etiket (Röle ile birlikte set olarak verilmektedir) / Marking Tag (Arriving as set with relay)	20	0,13
8036330060	LED FC R 6-24 VAC/DC	Harici Led Modülü / External Led Modul	5	2,60
8036330000	CP- TRS	Plastik Röle Tutucu / Plastic Relay Holder	20	0,65
8036331003	JP TS-P-2C-8	TRS Serisi için 8 Kutuplu Köprü / 8 pole jumper for TRS Series	5	6,50

2CO 10A Kalın Tip Endüstriyel Röle

Plug-In Industrial Relay



Ürün Kodu Product Code	Ürün Adı Product Name	Açıklama Explanation	Amb. Mik. Pack. Qty (Adet/Pcs.)	Birim Fiyatı Unit Price (USD/Adet)
8036322010	TRB LT-2C-10A-24 V DC	2CO, 10A, 24V DC, LED+Test Butonlu Röle / Test Button Plug-In Industrial Relay	20	7,54
8036322020	TRB LT-2C-10A-48 V DC	2CO, 10A, 48V DC, LED+Test Butonlu Röle / Test Button Plug-In Industrial Relay	20	8,58
8036322030	TRB LT-2C-10A-110 V DC	2CO, 10A, 110V DC, LED+Test Butonlu Röle / Test Button Plug-In Industrial Relay	20	8,58
8036322040	TRB LT-2C-10A-24 V AC	2CO, 10A, 24V AC, LED+Test Butonlu Röle / Test Button Plug-In Industrial Relay	20	8,58
8036322050	TRB LT-2C-10A-48 V AC	2CO, 10A, 48V AC, LED+Test Butonlu Röle / Test Button Plug-In Industrial Relay	20	8,58
8036322060	TRB LT-2C-10A-115 V AC	2CO, 10A, 115V AC, LED+Test Butonlu Röle / Test Button Plug-In Industrial Relay	20	8,58
8036322070	TRB LT-2C-10A-230 V AC	2CO, 10A, 230V AC, LED+Test Butonlu Röle / Test Button Plug-In Industrial Relay	20	8,58

4CO 5A Kalın Tip Endüstriyel Röle

Plug-In Industrial Relay



Ürün Kodu Product Code	Ürün Adı Product Name	Açıklama Explanation	Amb. Mik. Pack. Qty (Adet/Pcs.)	Birim Fiyatı Unit Price (USD/Adet)
8036324500	TRB LT-4C-5A-12 V DC	4CO, 5A, 12V DC, LED+Test Butonlu Röle / Test Button Plug-In Industrial Relay	20	7,67
8036324510	TRB LT-4C-5A-24 V DC	4CO, 5A, 24V DC, LED+Test Butonlu Röle / Test Button Plug-In Industrial Relay	20	7,67
8036324520	TRB LT-4C-5A-48 V DC	4CO, 5A, 48V DC, LED+Test Butonlu Röle / Test Button Plug-In Industrial Relay	20	7,67
8036324530	TRB LT-4C-5A-110 V DC	4CO, 5A, 110V DC, LED+Test Butonlu Röle / Test Button Plug-In Industrial Relay	20	9,10
8036324540	TRB LT-4C-5A-24 V AC	4CO, 5A, 24V AC, LED+Test Butonlu Röle / Test Button Plug-In Industrial Relay	20	8,65
8036324550	TRB LT-4C-5A-48 V AC	4CO, 5A, 48V AC, LED+Test Butonlu Röle / Test Button Plug-In Industrial Relay	20	9,10
8036324560	TRB LT-4C-5A-115 V AC	4CO, 5A, 110V AC, LED+Test Butonlu Röle / Test Button Plug-In Industrial Relay	20	9,10
8036324570	TRB LT-4C-5A-230 V AC	4CO, 5A, 220V AC, LED+Test Butonlu Röle / Test Button Plug-In Industrial Relay	20	8,65

Aksesuarlar

Accessories



Ürün Kodu Product Code	Ürün Adı Product Name	Açıklama Explanation	Amb. Mik. Pack. Qty (Adet/Pcs.)	Birim Fiyatı Unit Price (USD/Adet)
8036024002	TS-V TRB 4C	2 & 4 Kontaklı Vidalı Röle Soketi / 2C & 4C Screw Relay Socket	10	5,85
8036224000	TS-P TRB 2C	2 Kontaklı Push-In Röle Soketi / 2C Push-In Relay Socket	10	7,80
8036224002	TS-P TRB 4C	4 Kontaklı Push-In Röle Soketi / 4C Push-In Relay Socket	10	10,73
8036330101	MARK- TRB	Etiket (Röle ile birlikte set olarak verilmektedir) / Marking Tag(Arriving as set with relay)	20	0,17
8036330060	LED FC R 6-24 VAC/DC	Harici Led Modülü / External Led Modul	5	2,60
8036330001	CP- TRB	Plastik Röle Tutucu / Plastic Relay Holder	20	0,65
8036331005	JP TS-P-4C-5	TRB Serisi için 5 Kutuplu Köprü / 5 pole jumper for TRS Series	5	6,50

Vida Bağlantılı 1CO PLC Röleler

Screw Type 1CO PLC Relays

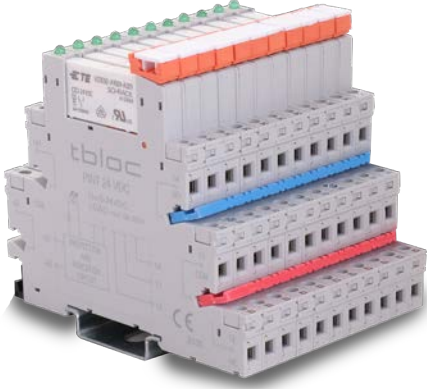

Ürün Kodu Product Code	Ürün Adı Product Name	Açıklama Explanation	Amb. Mik. Pack. Qty (Adet/Pcs.)	Birim Fiyatı Unit Price (USD/Adet)
8031241500	PINT-1C 24 V DC - 6A	1CO, 24V DC Röle + Soket / Relay and Socket	20	15,60
8031241510	PINT-1C 24 VAC/DC - 6A	1CO, 12-24V AC/DC Röle + Soket / Relay and Socket	20	15,60
8031241511	PINT-1C 60 VAC/DC - 6A	1CO, 48-60V AC/DC Röle + Soket / Relay and Socket	20	20,80
8031241512	PINT-1C 110 VAC/DC - 6A	1CO, 110-125V AC/DC Röle + Soket / Relay and Socket	20	20,80
8031241513	PINT-1C 230 VAC/DC - 6A	1CO, 220-240V AC/DC Röle + Soket / Relay and Socket	20	20,80

Vida Bağlantılı 2CO PLC Röleler

Screw Type 2CO PLC Relays



Ürün Kodu Product Code	Ürün Adı Product Name	Açıklama Explanation	Amb. Mik. Pack. Qty (Adet/Pcs.)	Birim Fiyatı Unit Price (USD/Adet)
8031241540	PINT-2C 24 V DC - 8A	2CO, 24V DC PLC Röle + Soket / Relay and Socket	20	31,20
8031241541	PINT-2C 12-24 VAC/DC - 8A	2CO, 12-24V AC/DC Röle + Soket / Relay and Socket	20	31,20
8031241542	PINT-2C 48-60 VAC/DC - 8A	2CO, 48-60V AC/DC Röle + Soket / Relay and Socket	20	36,40
8031241543	PINT-2C 110-125 VAC/DC - 8A	2CO, 110-125V AC/DC Röle + Soket / Relay and Socket	20	36,40
8031241544	PINT-2C 220-240 VAC/DC - 8A	2CO, 220-240V AC/DC Röle + Soket / Relay and Socket	20	36,40

Aksesuarlar

Accessories



Ürün Kodu Product Code	Ürün Adı Product Name	Açıklama Explanation	Amb. Mik. Pack. Qty (Adet/Pcs.)	Birim Fiyatı Unit Price (USD/Adet)
8031241533	PINT GİRİŞ ADAPTÖRÜ	PINT 1C Serisi PLC Röle Adaptör / Adaptor for PINT 1C PLC Relays	20	31,20

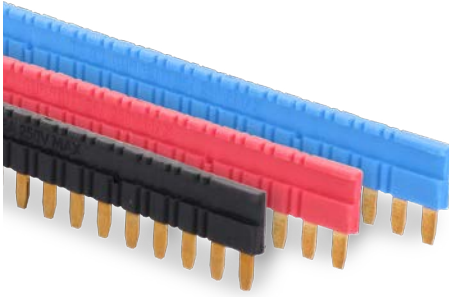

Ürün Kodu Product Code	Ürün Adı Product Name	Açıklama Explanation	Amb. Mik. Pack. Qty (Adet/Pcs.)	Birim Fiyatı Unit Price (USD/Adet)
8036331000	JP PINT-20-MAVİ	PINT 1C Serisi için 20 Kutuplu Köprü / 20 Pole jumper for PINT 1C (Blue)	5	6,50
8036331001	JP PINT-20-SİYAH	PINT 1C Serisi için 20 Kutuplu Köprü / 20 Pole jumper for PINT 1C (Black)	5	6,50
8036331002	JP PINT-20-KIRMIZI	PINT 1C Serisi için 20 Kutuplu Köprü / 20 Pole jumper for PINT 1C (Red)	5	6,50

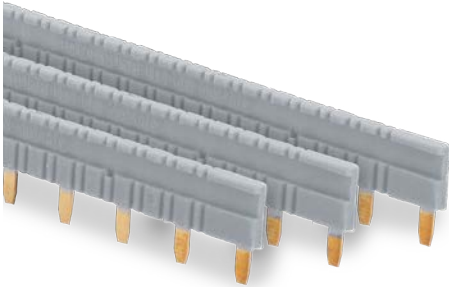

Ürün Kodu Product Code	Ürün Adı Product Name	Açıklama Explanation	Amb. Mik. Pack. Qty (Adet/Pcs.)	Birim Fiyatı Unit Price (USD/Adet)
8036331007	JP PINT-8-GRİ	PINT 2C Serisi için 8 Kutuplu Köprü / 8 Pole jumper for PINT 2C (Gray)	5	7,80

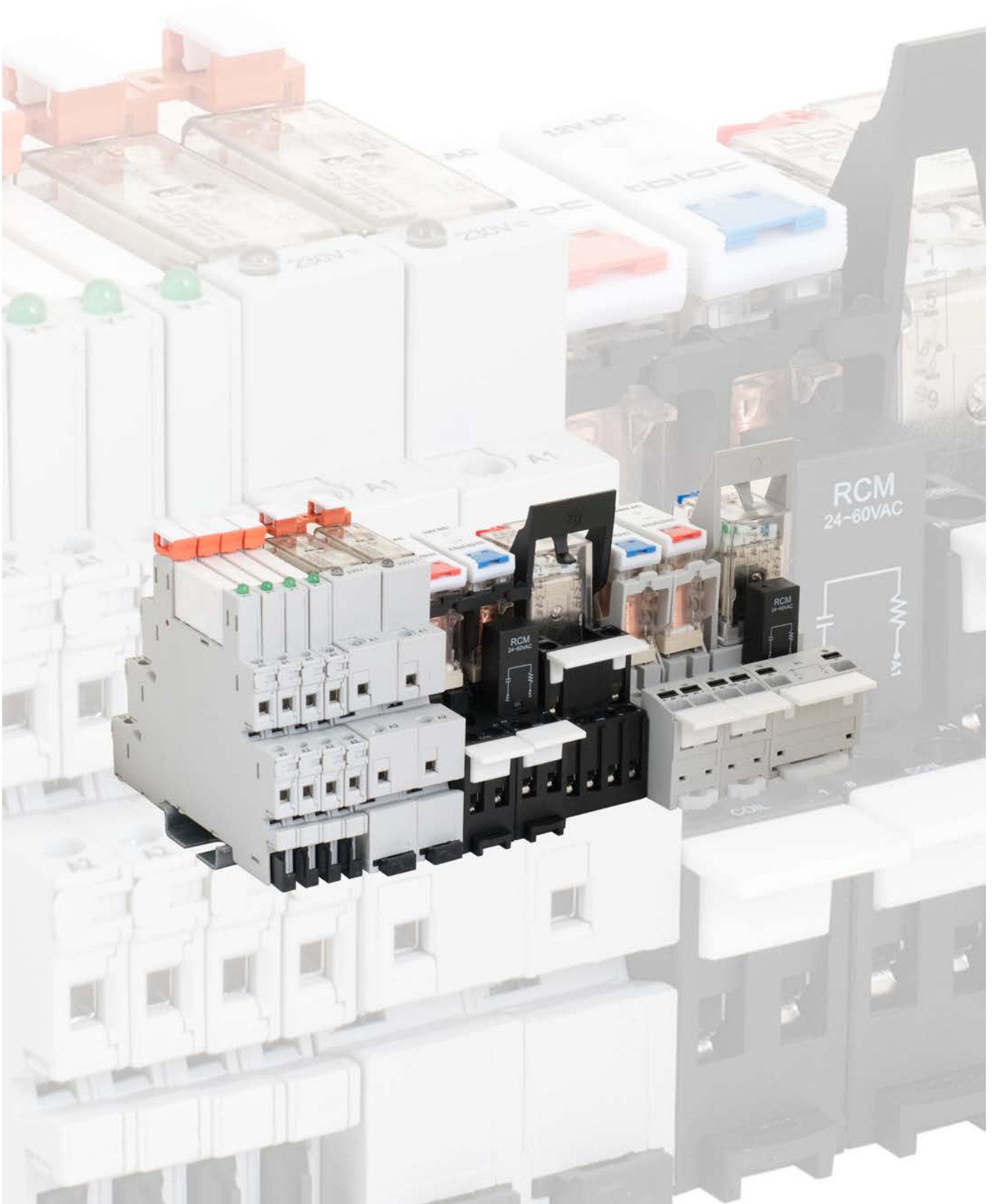



MERKEZ

Tbloc Elektrik Elektronik San. ve Tic. A.Ş.

29 Ekim Mahallesi 10001 Sokak No: 50/4

35663 Menemen İzmir Turkey

Tel: +90 232 833 26 96

Fax: +90 232 833 26 97

İSTANBUL AVRUPA BÖLGE

Gsm: +90 539 599 20 45

E-mail: istanbulavrupa@tbloc.com.tr

İSTANBUL ANADOLU BÖLGE

Gsm: +90 539 599 20 45

E-mail: istanbulanadolu@tbloc.com.tr

EGE ve AKDENİZ BÖLGESİ

Gsm: +90 539 776 08 15

E-mail: egebolge@tbloc.com.tr

İÇ ANADOLU BÖLGE

Gsm: +90 539 599 18 02

E-mail: icanadolubolge@tbloc.com.tr

GÜNEY ANADOLU BÖLGE

Gsm: +90 539 334 94 48

E-mail: guneyanadolubolge@tbloc.com.tr

info@tbloc.com.tr

www.tbloc.com.tr

YETKİLİ SATICI

--