

tbloc
Electrical & Electronic Manufacturing

ÜRÜN KATALOĞU
PRODUCT CATALOG
2026

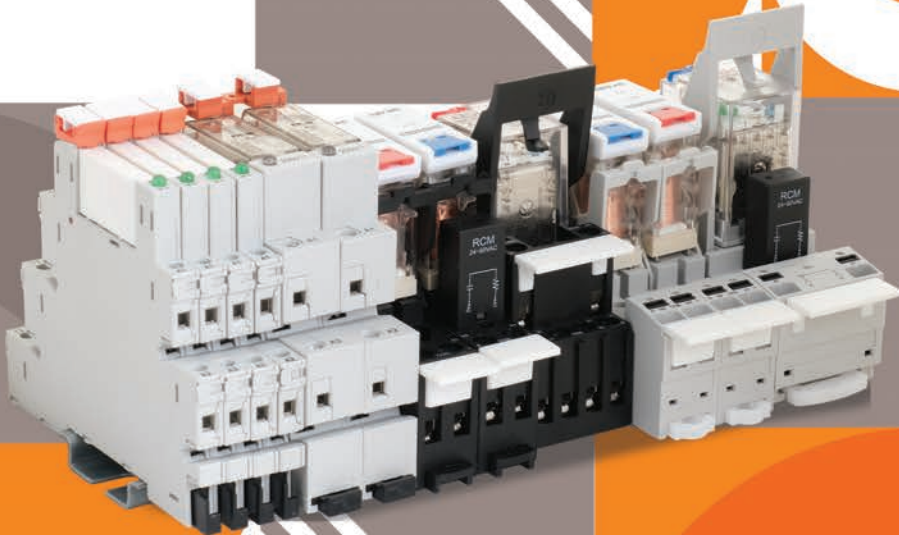
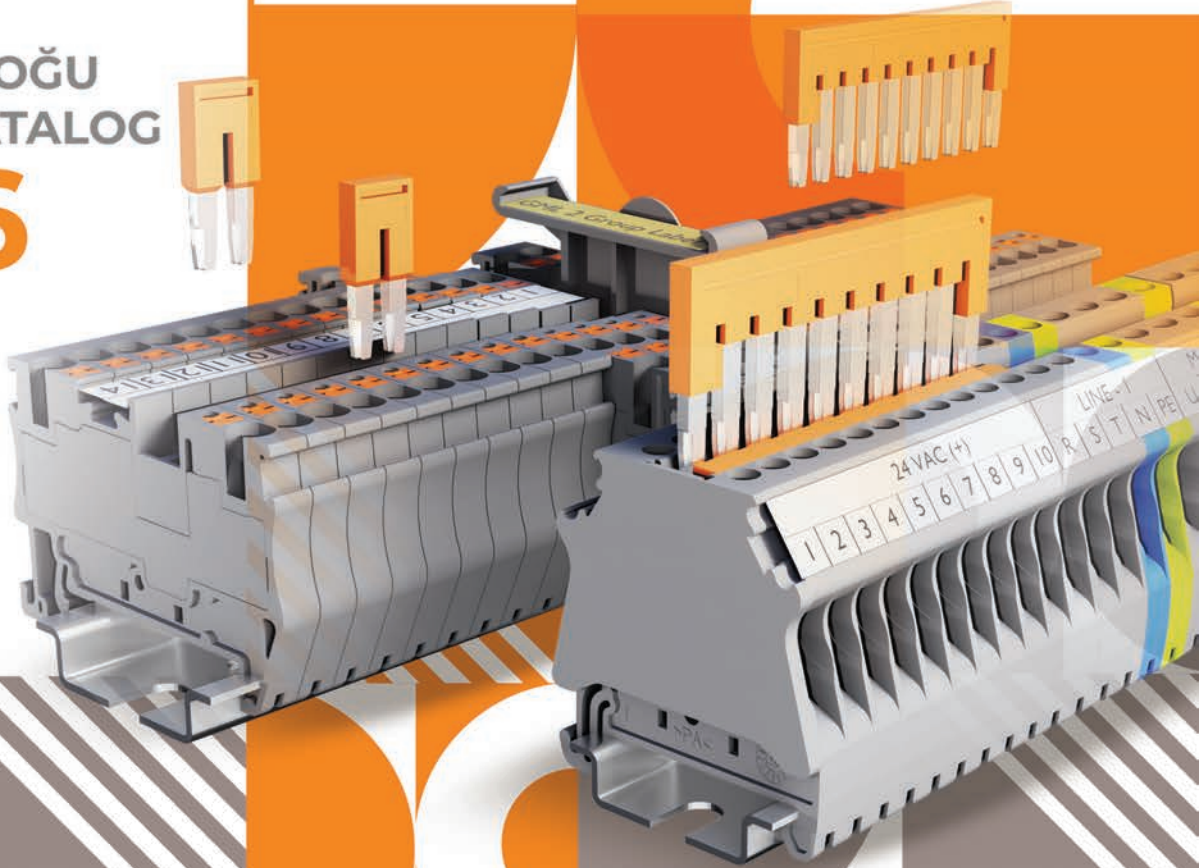

İçindekiler

Index

NTB Kompakt Vida Bağlantılı Ray Klemensleri	NTB Compact Screw Type Terminal Blocks	06 - 13
Vida Bağlantılı Ray Klemensleri	Screw Type Terminal Blocks	14 - 39
Push-in Klemensleri	Push-in Terminal Blocks	40 - 59
Sıra Klemensleri v e Durdurucular	Terminal Strips and End Bracket	60
Grup Etiketleri ve Etiket Şemsiyesi	Group Marker and Marker Holder	61
Nihayet Plakaları ve Ayırma Plakaları	End Plates and Partition Plates	62 - 63
Üst Köprüler	Cross Connections	64 - 65
Tarak Köprüler, Kayar Köprüler ve Test Fişleri	Comb Connector, Sliding Connector and Test Sockets	66
Klemens Etiketleri	Marking Tags	67 - 70
Montaj Rayları	Mounting Rails	71
Kanal ve Ray Kesme Makası	Wiring Duct and Din Rail Cutter	72
Dağıtım Blokları	Distribution Blocks	73 - 85
Pano Tipi Delikli Kablo Kanalları	Panel Type Slotted Wiring Ducts	86 - 87
Markalama Sistemleri	Marking Systems	88 - 102
Müşterek w otomat baraları	Pin mcb busbars	103
Paslanmaz Çelik Kablo Bağları - 304 Kalite	Stainless Steel Cable Ties - Grade 304	104
Plastik Kablo Bağları	Plastic Cable Ties	105
Kroşeler ve Kablo Bağı Sıkma ve Kesme Aleti	Tie Mounts and Cable Tie Tightening and Cutting Tool	106
Plastik Kablo Etiketleri	Plastic Cable Label	107 - 109
Kablo Pabuçları ve Ek Muflar	Cable Lugs and Butt Terminals	110 - 111
Kablo Yüksükleri	End Sleeves	112 - 120
Sinyal Lambaları ve Butonlar	Led Indicators and Buttons	121 - 127
Endüstriyel ve PLC Röleler	Industrial and Interface Relays	128 - 134

TBLOC 2020 yılının Ocak ayında İzmir’de kurulmuş bir endüstri firmasıdır. Yeni bir firma olmasına rağmen kökleri uzun yıllara dayanan tecrübe ve birikimler nedeniyle çok derindedir. TBLOC, Türkiye’nin yeni bağlantı elemanları markası olarak Ar-Ge, Üretim ve Satış faaliyetlerini tek çatı altında yürütmekte ve bir Türk markası olarak uluslararası standartlarda ürettiği ürünleri tüm dünyaya ihraç etmektedir.

TBLOC markası, klemensin İngilizce karşılığı olan Terminal Block kelimelerinin bir kısaltması olarak görünse de “t” harfi teknolojinin kısaltması olarak markamızın başında, şirketimizin uzun vadeli planlarının göstergesi olarak yerini almıştır.

Tbloc Kurumsal



TBLOC is an industrial company established in January 2020 in İzmir/Turkey. Even though TBLOC is a new company, it has deep roots backed up with long years experience and knowledge. TBLOC, as a new brand in connectivity industry, is gathering all R&D, production and sales & marketing functions under one roof with the aim of becoming a global brand and supplying to international markets.

Despite TBLOC brand is being perceived as an abbreviation of Terminal Block definition, first letter "t" stands for technology and indicates our company's long term vision.

Tbloc Corporate

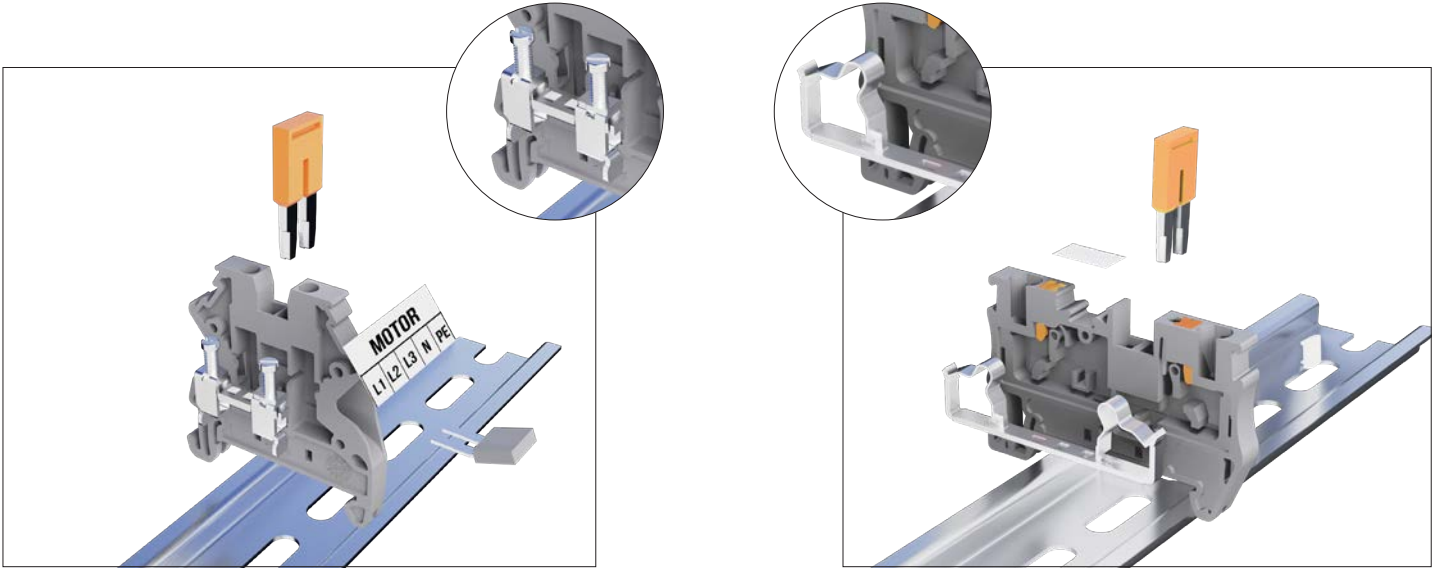

Vida Bağlantısı

Vidalı bağlantı bilinen en klasik bağlantı yöntemidir. Isıl işlem ile güçlendirilmiş sac ayaklar sayesinde uzun dönemde güvenli ve dayanıklı saha kullanımı mümkündür.

Güvenilir Bağlantı Ünitesi

Vidalı klemenslerde yer alan bağlantı ünitesi de (klemens ayağı), vidalarda olduğu gibi güçlendirilmiş çelikten üretilmektedir. Vida sıkıldığında bağlantı ünitesinde meydana gelen kuvvet bir kilitleme mekanizması oluşturur. Bu sistem sayesinde, uzun ömürlü ve güvenli bağlantı elde edilmektedir.

Push-in Bağlantı

Tbloc push-in klemensler, herhangi bir alet kullanmaksızın kolay ve hızlı montaj avantajı sağlamaktadır. Bu bağlantı teknolojisi sayesinde; tek damarlı kablolar ön hazırlığa gerek duymaksızın, çok damarlı kablolar da yükseklik olarak kolayca montajlanabilir. Ayrıca klemens üzerinde yer alan kırmızı butonlar, kullanıcıya klemensin iletken kısımlarına temas etmeden demontaj avantajı sağlamaktadır. Push-in bağlantılı klemensler titreşime karşı dayanıklıdır.

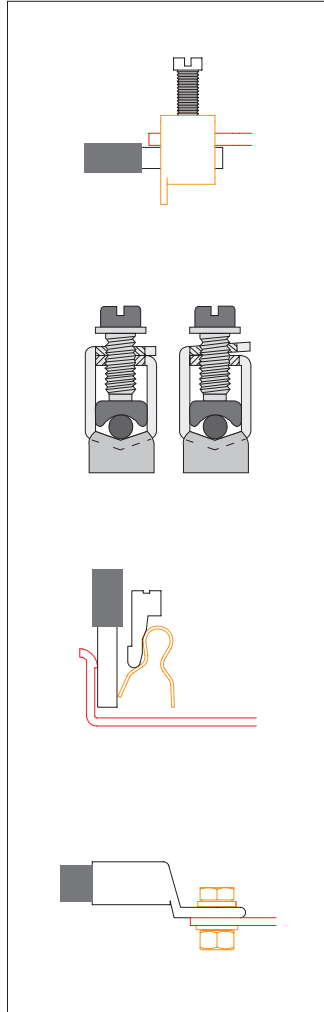

Screw Connection

Screw type connection is the classical method for terminal blocks. Reinforced clamps ensures the safe and durable connection for long time of usage.

Reliable Clamping

The connection unit (yokes) in the terminal block is made of reinforced steel, as in the screw. When the screw is tightened, the force that occurs in the connection unit creates a locking mechanism. Thanks to that, durable and safe connection is obtained.

Push-in Connection

Tbloc push-in terminal blocks provide fast assembly of cables without using a tool. With this technology, solid conductors (just stripping is enough) and flexible conductors (with end ferrules) can be assembled easily. Red buttons on top of the terminal blocks provide easy disassembly without touching conductive parts of the terminal blocks. Push-in connection is resistant to vibration hence can be used safely in many areas.

NTB

Geçiş Klemensleri
Çok Katlı Klemensler
Sigortalı ve Ayırmalı Klemensler
Topraklama Klemensleri

Kompakt Tasarım
11.4 mm Şerit Etiket
Pratik Üst Köprü

NTB

Feed Through Terminal Blocks
Multi Level Terminal Blocks
Fuse and Disconnect Terminal Blocks
Earth Terminal Blocks

Compact Desing
11.4 mm Strip Label
Plug -In Cross Connection

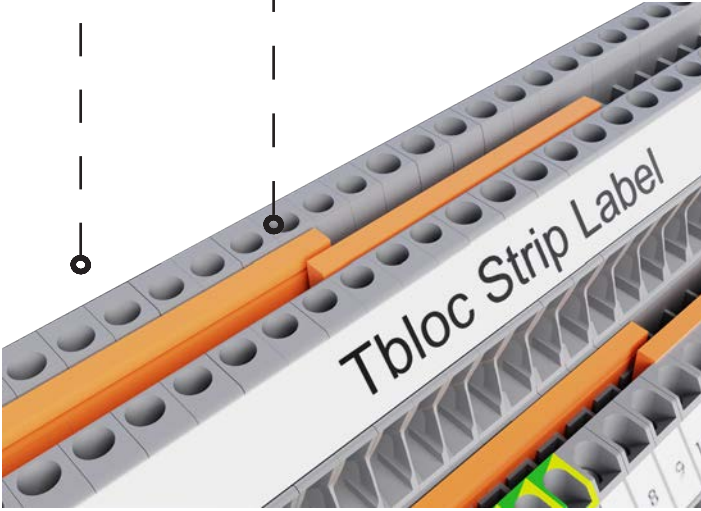

- Kompakt Tasarım
- **Compact Desing**

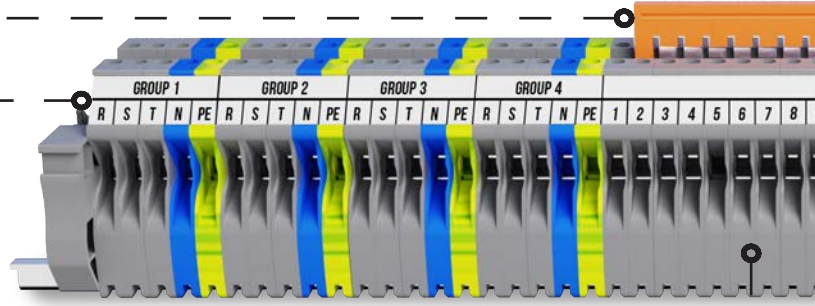

- Pratik Üst Köprü
- 11.4 mm Şerit Etiket
- **Plug -In Cross Connection**
- **11.4 mm Strip Label**

Genişlik / Width : 5,2 mm

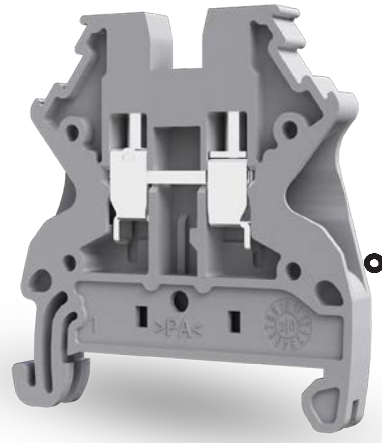



EAC

YENİ ÜRÜN
NEW PRODUCT

2024

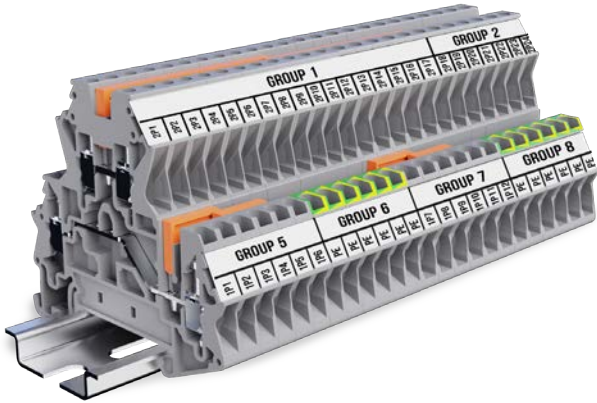
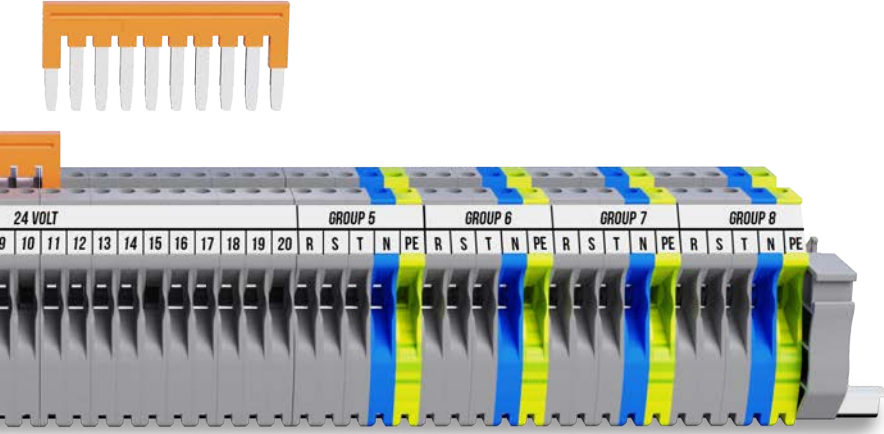

- Çok Katlı Klemensler
- Multi Level Terminal Blocks

- Sigortalı ve Ayırmalı Klemensler
- Fuse and Disconnect Terminal Blocks

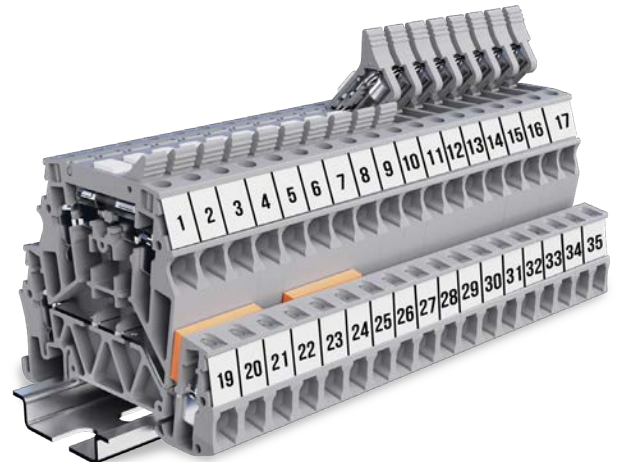

Vida Bağlantılı Ray Klemensleri Screw Type Terminal Blocks

NTB Serisi Geçiş Klemensleri

NTB Series Feed Through Terminal Block



NTB 2,5

YENİ
NEW

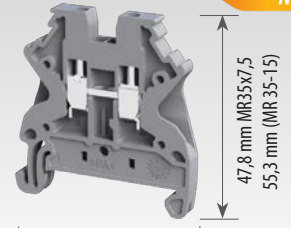

45,2 mm

Genişlik / Width : 5,2 mm



Ürün Adı / Product Name

NTB 2,5

Sipariş No / Order No.

8000099208

Paket Adeti / Packing Qty.

100

Anma Değerleri / Rated Values

IEC 60947-7-1

800 V / 24 A

Bağlantı Bilgileri / Connection Information

Kesit / Cross-Section (mm²)

2,5

Tek Damarlı Kablo / Solid Conductor Cross-Section min-max mm²

0,5 - 4

Çok Damarlı Kablo / Stranded Conductor Cross-Section min-max mm²

0,5 - 4

Çok Tellî Kablo / Flexible Conductor Cross-Section min-max mm²

0,5 - 2,5

AWG

20-12 AWG

Açıklamalar / Descriptions

Kablo Soyma Uzunluğu / Insulation Stripping Length (mm)

10

Max. Sıkma Torku (N.m) / Max. Tightening Torque

0,6

Bağlantı Vidası / Screw Diameter

M2,5

Darbe Gerilimi / Rated Impulse Voltage (Kv)

6

Kirlilik Derecesi / Gerilim Kategorisi / Malzeme Grubu / Pollution Degree / Voltage Category / Material Group

3 / III / I

Aksesuarlar / Accessories

Montaj Rayı / Din Rail

Ürün Adı Product Name	Sipariş No Order No.	Adet Qty.
DR 35-7,5 S 2M	8015393407	40
DR 35-15 S 2M	8015393427	20
SS 1	8010097308	50
SS 2	8010097318	50
PS 1	8010197328	50
PS 2	8010197420	50
PCC 2,5/2	8013294523	100
PCC 2,5/3	8013294533	100
PCC 2,5/10	8013294503	10
TCC 2,5/2	8013094223	50
TCC 2,5/3	8013094203	50
TCC 2,5/10	8013094233	10
EPL NTB 2,5-10	8012396288	50
MTG 5	8020389009	500
TBSL 22x20	8020384009	1
GM1	8014393008	50
GM2	8014393018	50
TM1	8014393020	50
0,5x3,0		

Durdurucu / End Stopper

Üst Köprü / Cross Connection

Tarak Köprü / Comb Connector

Nihayet Plakası / End Plate

Klemens Etiketi / Marking Tags

Şerit Etiket / Strip Label

Grup Etiketi / Group Label

Tornavida / Screwdriver

* TM1 Sadece PS2 ürünü ile Uyumludur.

* TM1 is only suitable for PS2

Renk Kodları / Color Codes

800009900....

...0

...1

...2

...3

...4

...5

...6

...9

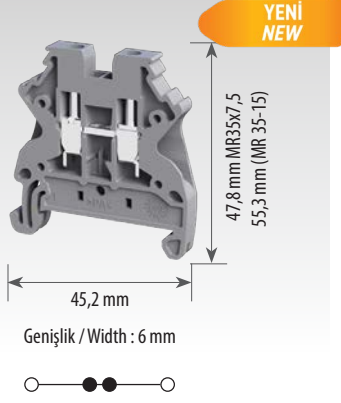
NTB 4**NTB 4**

8000099308

85

800 V / 32 A

4

0,5 - 6

0,5 - 6

0,5 - 4

20-10 AWG

10

0,8

M3

6

3 / III / I

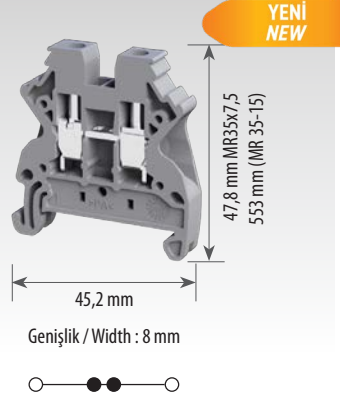
NTB 6**NTB 6**

8000099408

65

800 V / 41 A

6

0,5 - 10

0,5 - 10

0,5 - 6

20-8 AWG

10

1,2

M3,5

8

3 / III / I

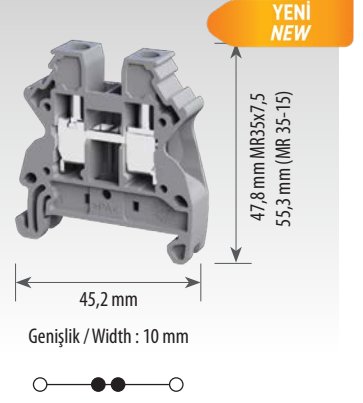
NTB 10**NTB 10**

8000099508

50

800 V / 57 A

10

1,5 - 16

1,5 - 16

1,5 - 10

20-6 AWG

10

1,5

M4

8

3 / III / I

Ürün Adı Product Name	Sipariş No Order No.	Adet Qty.
DR 35-7,5 S 2M	8015393407	40
DR 35-15 S 2M	8015393427	20
SS 1	8010097308	50
SS 2	8010097318	50
PS 1	8010197328	50
PS 2	8010197420	50
PCC 4/2	8013294623	100
PCC 4/3	8013294633	100
PCC 4/10	8013294603	10
TCC 4/2	8013094323	50
TCC 4/3	8013094333	50
TCC 4/10	8013094303	10
EPL NTB 2,5-10	8012396288	50
MTG 6	8020388009	500
TBSL 22x20	8020384009	1
GM1	8014393008	50
GM2	8014393018	50
TM1	8014393020	50
0,5x3,0		

Ürün Adı Product Name	Sipariş No Order No.	Adet Qty.
DR 35-7,5 S 2M	8015393407	40
DR 35-15 S 2M	8015393427	20
SS 1	8010097308	50
SS 2	8010097318	50
PS 1	8010197328	50
PS 2	8010197420	50
PCC 6/2-T	8013295723	50
PCC 6/3-T	8013295733	50
PCC 6/10-T	8013295703	10
EPL NTB 2,5-10	8012396288	50
MTG 8	8020386009	500
TBSL 22x20	8020384009	1
GM1	8014393008	50
GM2	8014393018	50
TM1	8014393020	50
0,6x3,5		

Ürün Adı Product Name	Sipariş No Order No.	Adet Qty.
DR 35-7,5 S 2M	8015393407	40
DR 35-15 S 2M	8015393427	20
SS 1	8010097308	50
SS 2	8010097318	50
PS 1	8010197328	50
PS 2	8010197420	50
PCC 10/2	8013294823	10
PCC 10/3	8013294833	10
EPL NTB 2,5-10	8012396288	50
MTG 10	8020385009	250
TBSL 22x20	8020384009	1
GM1	8014393008	50
GM2	8014393018	50
TM1	8014393020	50
0,6x3,5		

* TM1 Sadece PS2 ürünü ile Uyumludur.

* TM1 is only suitable for PS2

Vida Bağlantılı Ray Klemensleri Screw Type Terminal Blocks

NTB Serisi Çok Katlı Klemensler NTB Series Multi Levels Terminal Blocks

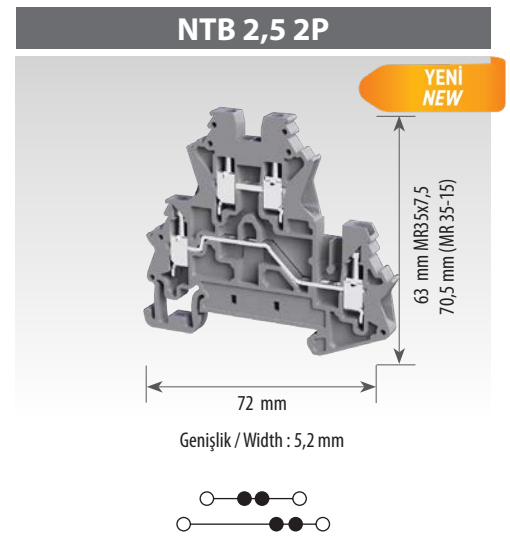

Ürün Adı / Product Name	NTB 2,5 2P		
Sipariş No / Order No.	8002099558		
Paket Adeti / Packing Qty.	30		
Anma Değerleri / Rated Values	500 V / 24 A		
Bağlantı Bilgileri / Connection Information			
Kesit / Cross-Section (mm²)	2,5		
Tek Damarlı Kablo / Solid Conductor Cross-Section min-max mm²	0,5 - 4		
Çok Damarlı Kablo / Stranded Conductor Cross-Section min-max mm²	0,5 - 4		
Çok Tellî Kablo / Flexible Conductor Cross-Section min-max mm²	0,5 - 2,5		
AWG	20-12 AWG		
Açıklamalar / Descriptions			
Kablo Soyma Uzunluğu / Insulation Stripping Length (mm)	10		
Max. Sıkma Torku (N.m) / Max. Tightening Torque	0,6		
Bağlantı Vidası / Screw Diameter	M2,5		
Darbe Gerilimi / Rated Impulse Voltage (Kv)	6		
Kirlilik Derecesi / Gerilim Kategorisi / Malzeme Grubu / Pollution Degree / Voltage Category / Material Group	3 / III / I		
Aksesuarlar / Accessories	Ürün Adı / Product Name	Sipariş No / Order No.	Adet / Qty.
Montaj Rayı / Din Rail	DR 35-7,5 S 2M	8015393407	40
	DR 35-15 S 2M	8015393427	20
Durdurucu / End Stopper	SS 1	8010097308	50
	SS 2	8010097318	50
	PS 1	8010197328	50
	PS 2	8010197420	50
Üst Köprü / Cross Connection	PCC 2,5/2	8013294523	100
	PCC 2,5/3	8013294533	100
	PCC 2,5/10	8013294503	10
Nihayet Plakası / End Plate	EPL NTB 2,5-4 2P	8012396388	20
Şerit Etiket / Strip Label	TBSL 22x20	8020384009	1
Klemens Etiketi / Marking Tags	MTG 5	8020389009	500
	GM1	8014393008	50
	GM2	8014393018	50
	TM1	8014393020	50
Grup Etiketi / Group Label	0,5x3,0		
Tornavida / Screwdriver			

* TM1 Sadece PS2 ürünü ile Uyumludur.

* TM1 is only suitable for PS2

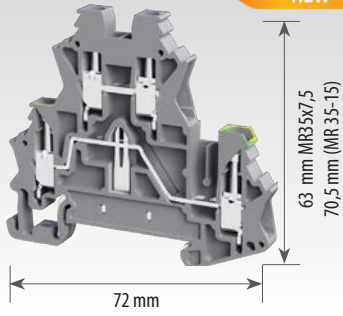
NTB 2,5 P + E**YENİ
NEW**

Genişlik / Width : 5,2 mm

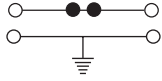
**NTB 2,5 P + E**

8002099568

30

500 V / 24 A

2,5

0,5 - 4

0,5 - 4

0,5 - 2,5

20-12 AWG

12

0,8

M3

6

3 / III / I

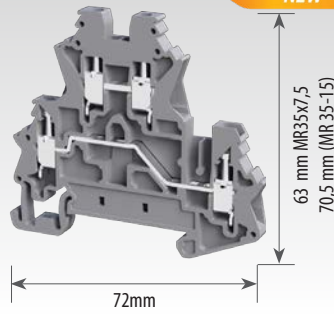
NTB 4 2P**YENİ
NEW**

Genişlik / Width : 6 mm

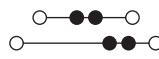
**NTB 4 2P**

8002099658

30

500 V / 32 A

4

0,5 - 6

0,5 - 6

0,5 - 4

20-10 AWG

12

0,8

M3

6

3 / III / I

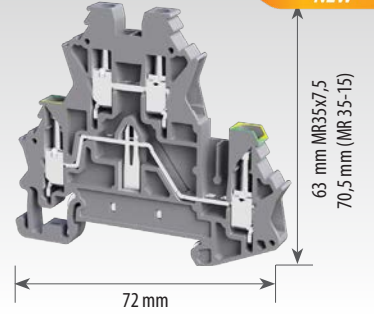
NTB 4 P + E**YENİ
NEW**

Genişlik / Width : 6 mm

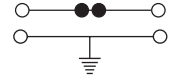
**NTB 4 P + E**

8002099668

30

500 V / 32 A

4

0,5 - 6

0,5 - 6

0,5 - 4

20-10 AWG

12

0,8

M3

6

3 / III / I

Ürün Adı Product Name	Sipariş No Order No.	Adet Qty.
DR 35-7,5 S 2M	8015393407	40
DR 35-15 S 2M	8015393427	20
SS 1	8010097308	50
SS 2	8010097318	50
PS 1	8010197328	50
PS 2	8010197420	50
PCC 2,5/2	8013294523	100
PCC 2,5/3	8013294533	100
PCC 2,5/10	8013294503	10
EPL NTB 2,5-4 2P	8012396388	20
TBSL 22x20	8020384009	1
MTG 5	8020389009	500
GM1	8014393008	50
GM2	8014393018	50
TM1	8014393020	50
0,5x3,0		

Ürün Adı Product Name	Sipariş No Order No.	Adet Qty.
DR 35-7,5 S 2M	8015393407	40
DR 35-15 S 2M	8015393427	20
SS 1	8010097308	50
SS 2	8010097318	50
PS 1	8010197328	50
PS 2	8010197420	50
PCC 4/2	8013294623	100
PCC 4/3	8013294633	100
PCC 4/10	8013294603	10
EPL NTB 2,5-4 2P	8012396388	20
TBSL 22x20	8020384009	1
MTG 6	8020388009	500
GM1	8014393008	50
GM2	8014393018	50
TM1	8014393020	50
0,6x3,5		

Ürün Adı Product Name	Sipariş No Order No.	Adet Qty.
DR 35-7,5 S 2M	8015393407	40
DR 35-15 S 2M	8015393427	20
SS 1	8010097308	50
SS 2	8010097318	50
PS 1	8010197328	50
PS 2	8010197420	50
PCC 4/2	8013294623	100
PCC 4/3	8013294633	100
PCC 4/10	8013294603	10
EPL NTB 2,5-4 2P	8012396388	20
TBSL 22x20	8020384009	1
MTG 6	8020388009	500
GM1	8014393008	50
GM2	8014393018	50
TM1	8014393020	50
0,6x3,5		

*** TM1 Sadece PS2 ürünü ile Uyumludur.**

* TM1 is only suitable for PS2

Vida Bağlantılı Ray Klemensleri Screw Type Terminal Blocks

NTB Serisi Topraklama Klemensleri NTB Series Earth Terminal Blocks



NTB 2,5 E

YENİ
NEW

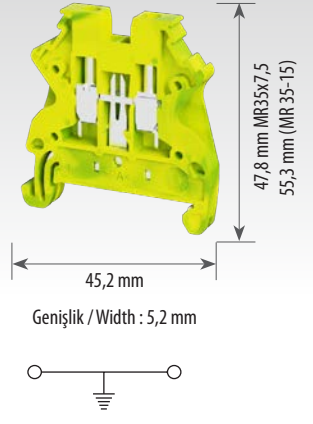

Ürün Adı / Product Name

Sipariş No / Order No.

Paket Adeti / Packing Qty.

Anma Değerleri / Rated Values

IEC 60947-7-1

Bağlantı Bilgileri / Connection Information

Kesit / Cross-Section (mm²)

Tek Damarlı Kablo / Solid Conductor Cross-Section min-max mm²

Çok Damarlı Kablo / Stranded Conductor Cross-Section min-max mm²

Çok Tellî Kablo / Flexible Conductor Cross-Section min-max mm²

AWG

Açıklamalar / Descriptions

Kablo Soyma Uzunluğu / Insulation Stripping Length (mm)

Max. Sıkma Torku (N.m) / Max. Tightening Torque

Bağlantı Vidası / Screw Diameter

Darbe Gerilimi / Rated Impulse Voltage (Kv)

Kirlilik Derecesi / Gerilim Kategorisi / Malzeme Grubu / Pollution Degree / Voltage Category / Material Group

Aksesuarlar / Accessories

Montaj Rayı / Din Rail

Durdurucu / End Stopper

Nihayet Plakası / End Plate

Şerit Etiket / Strip Label

Klemens Etiketi / Marking Tags

Grup Etiketi / Group Label

Tornavida / Screwdriver

NTB 2,5 E

8001099304

70

-

2,5

0,5 - 4

0,5 - 4

0,5 - 2,5

20-12 AWG

12

0,6

M2,5

6

3 / III / I

Ürün Adı Product Name	Sipariş No Order No.	Adet Qty.
DR 35-7,5 S 2M	8015393407	40
DR 35-15 S 2M	8015393427	20
SS 1	8010097308	50
SS 2	8010097318	50
PS 1	8010197328	50
PS 2	8010197420	50
EPL NTB 2,5-10 E	8012396284	50
TBSL 22x20	8020384009	1
MTG 5	8020389009	500
GM1	8014393008	50
GM2	8014393018	50
TM1	8014393020	50
0,5x3,0		

* TM1 Sadece PS2 ürünü ile uyumludur.

* TM1 is only suitable for PS2

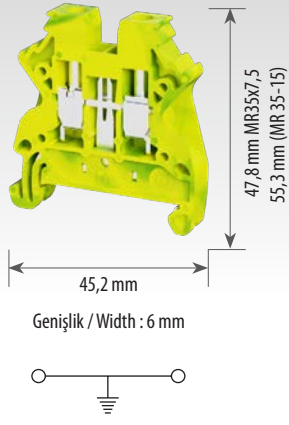
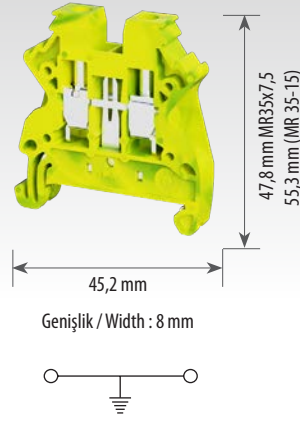
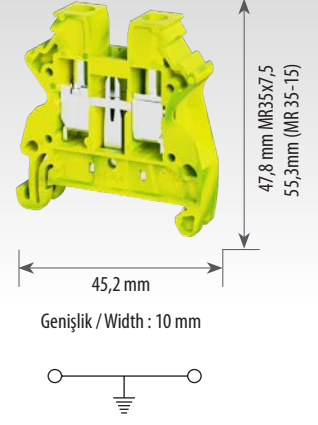
NTB 4 E**YENİ
NEW****NTB 6 E****YENİ
NEW****NTB 10 E****YENİ
NEW****NTB 4 E**

8001099314

60

4

0,5 - 6

0,5 - 6

0,5 - 4

20-10 AWG

12

0,8

M3

6

3 / III / I

NTB 6 E

8001099324

45

6

1,5 - 6

1,5 - 6

1,5 - 6

20-8 AWG

12

1,2

M3,5

8

3 / III / I

NTB 10 E

8001099334

35

10

1,5 - 10

1,5 - 10

1,5 - 10

20-6 AWG

12

1,5

M4

8

3 / III / I

Ürün Adı Product Name	Sipariş No Order No.	Adet Qty.
DR 35-7,5 S 2M	8015393407	40
DR 35-15 S 2M	8015393427	20
SS 1	8010097308	50
SS 2	8010097318	50
PS 1	8010197328	50
PS 2	8010197420	50
EPL NTB 2,5-10 E	8012396284	50
TBSL 22x20	8020384009	1
MTG 6	8020388009	500
GM1	8014393008	50
GM2	8014393018	50
TM1	8014393020	50
0,5x3,0		

Ürün Adı Product Name	Sipariş No Order No.	Adet Qty.
DR 35-7,5 S 2M	8015393407	40
DR 35-15 S 2M	8015393427	20
SS 1	8010097308	50
SS 2	8010097318	50
PS 1	8010197328	50
PS 2	8010197420	50
EPL NTB 2,5-10 E	8012396284	50
TBSL 22x20	8020384009	1
MTG 8	8020386009	500
GM1	8014393008	50
GM2	8014393018	50
TM1	8014393020	50
0,6x3,5	8014393018	50

Ürün Adı Product Name	Sipariş No Order No.	Adet Qty.
DR 35-7,5 S 2M	8015393407	40
DR 35-15 S 2M	8015393427	20
SS 1	8010097308	50
SS 2	8010097318	50
PS 1	8010197328	50
PS 2	8010197420	50
EPL NTB 2,5-10 E	8012396284	50
TBSL 22x20	8020384009	1
MTG 10	8020385009	250
GM1	8014393008	50
GM2	8014393018	50
TM1	8014393020	50
0,6x3,5	8014393018	50

* TM1 Sadece PS2 ürünü ile Uyumludur.

* TM1 is only suitable for PS2

Vida Bağlantılı Ray Klemensleri Screw Type Terminal Blocks

NTB Serisi Çok Katlı Topraklamalı Klemensler NTB Series Multi Levels Earth Terminal Blocks



NTB 2,5 2P E

YENİ
NEW

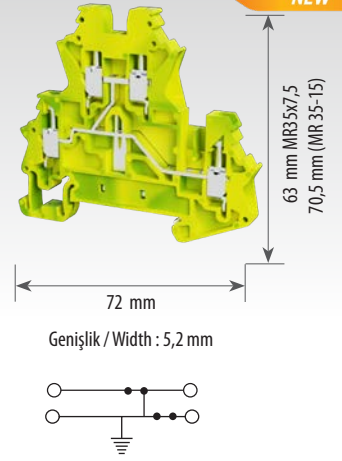

Genişlik / Width : 5,2 mm

Ürün Adı / Product Name

Sipariş No / Order No.

Paket Adeti / Packing Qty.

Anma Değerleri / Rated Values

IEC 60947-7-2

Bağlantı Bilgileri / Connection Information

Kesit / Cross-Section (mm²)

Tek Damarlı Kablo / Solid Conductor Cross-Section min-max mm²

Çok Damarlı Kablo / Stranded Conductor Cross-Section min-max mm²

Çok Telli Kablo / Flexible Conductor Cross-Section min-max mm²

AWG

Açıklamalar / Descriptions

Kablo Soyma Uzunluğu / Insulation Stripping Length (mm)

Max. Sıkma Torku (N.m) / Max. Tightening Torque

Bağlantı Vidası / Screw Diameter

Darbe Gerilimi / Rated Impulse Voltage (Kv)

Kirlilik Derecesi / Gerilim Kategorisi / Malzeme Grubu / Pollution Degree / Voltage Category / Material Group

Aksesuarlar / Accessories

Montaj Rayı / Din Rail

Durdurucu / End Stopper

Nihayet Plakası / End Plate

Şerit Etiket / Strip Label

Klemens Etiketi / Marking Tags

Grup Etiketi / Group Label

Tornavida / Screwdriver

NTB 2,5 2P E

8002099574

2,5

0,5 - 4

0,5 - 4

0,5 - 2,5

20-12 AWG

10

0,6

M2,5

6

3 / III / I

Ürün Adı Product Name	Sipariş No Order No.	Adet Qty.
DR 35-7,5 S 2M	8015393407	40
DR 35-15 S 2M	8015393427	20
SS 1	8010097308	50
SS 2	8010097318	50
PS 1	8010197328	50
PS 2	8010197420	50
EPL NTB 2,5-4 2P E	8012396384	20
TBSL 22x20	8020384009	1
MTG 5	8020389009	500
GM1	8014393008	50
GM2	8014393018	50
TM1	8014393020	50
0,5x3,0		

* TM1 Sadece PS2 ürünü ile Uyumludur.

* TM1 is only suitable for PS2

NTB 4 2P E

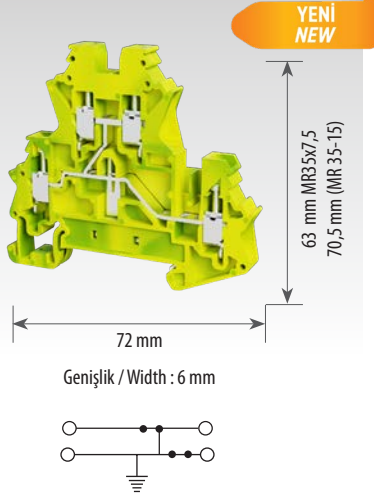

Genişlik / Width : 6 mm

NTB 4 2P E

8002099674

4

0,5 - 6

0,5 - 6

0,5 - 4

20-10 AWG

10

0,8

M4

6

3 / III / I

Ürün Adı Product Name	Sipariş No Order No.	Adet Qty.
DR 35-7,5 S 2M	8015393407	40
DR 35-15 S 2M	8015393427	20
SS 1	8010097308	50
SS 2	8010097318	50
PS 1	8010197328	50
PS 2	8010197420	50
EPL NTB 2,5-4 2P E	8012396384	20
TBSL 22x20	8020384009	1
MTG 6	8020388009	500
GM1	8014393008	50
GM2	8014393018	50
TM1	8014393020	50
0,5x3,0		

* TM1 Sadece PS2 ürünü ile Uyumludur.

* TM1 is only suitable for PS2

Vida Bağlantılı Ray Klemensleri Screw Type Terminal Blocks

TBL Serisi Geçiş Klemensleri

TBL Series Feed Through Terminal Block



Ürün Adı / Product Name

Sipariş No / Order No.

Paket Adeti / Packing Qty.

Anma Değerleri / Rated Values

IEC 60947-7-1

Bağlantı Bilgileri / Connection Information

Kesit / Cross-Section (mm²)

Tek Damarlı Kablo / Solid Conductor Cross-Section min mm²: (mm²)-(min-max)

Çok Damarlı Kablo / Stranded Conductor Cross-Section (mm²)-(min-max)

Çok Telli Kablo / Flexible Conductor Cross-Section (mm²)-(min-max)

AWG

Açıklamalar / Descriptions

Kablo Soyma Uzunluğu / Insulation Stripping Length (mm)

Max. Sıkma Torku (N.m) / Max. Tightening Torque

Bağlantı Vidası / Screw Diameter

Darbe Gerilimi / Rated Impulse Voltage (Kv)

Kirlilik Derecesi / Gerilim Kategorisi / Malzeme Grubu / Pollution Degree / Voltage Category / Material Group

Aksesuarlar / Accessories

Montaj Rayı / Din Rail

Durdurucu / End Stopper

Nihayet Plakası / End Plate

Ayırma Plakası / Partition Plate

Mini Ayırma Dili / Small Partition Plate

Üst Köprü / Cross Connection

Tarak Köprü / Comb Connector

Test Fişi / Test Plug

Klemens Etiketi / Marking Tags

Şerit Etiket / Strip Label

Grup Etiketi / Group Label

Tornavida / Screwdriver

Renk Kodları / Color Codes

800009900....

...0

...1

...2

...3

...4

...5

...6

...9

TBL 2,5

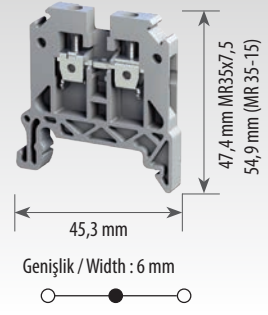

TBL 2,5

8000099008

100

500 V / 24 A

2,5

0,5 -4

0,5 -4

0,5 -2,5

20-12 AWG

10

0,6

M2,5

6

3 / III / I

Ürün Adı Product Name	Sipariş No Order No.	Adet Qty.
DR 35-7,5 S 2M	8015393407	40
DR 35-15 S 2M	8015393427	20
SS 1	8010097308	50
SS 2	8010097318	50
PS 1	8010197328	50
PS 2	8010197420	50
EPL TBL 2,5-10	8012396118	50
PR TBL 2,5-10	8012396408	100
SPR 2,5-10	8012396528	100
SCC 2,5/2	8013095023	50
SCC 2,5/3	8013095033	50
SCC 2,5/10	8013095003	10
TCC 2,5/2	8013094223	50
TCC 2,5/3	8013094203	50
TCC 2,5/10	8013094233	10
TST 1	8014393227	50
MTG 6	8020388009	500
TBSL 5,15x5	8020384011	1
GM1	8014393008	50
GM2	8014393018	50
TM1	8014393020	50
0,5x3,0		

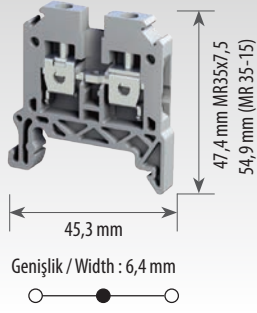
TBL 4**TBL 4**

8000099028

100

800 V / 32 A

4

0,5 - 6

0,5 - 6

0,5 - 4

20-10 AWG

12

0,8

M3

6

3 / III / I

Ürün Adı Product Name	Sipariş No Order No.	Adet Qty.
DR 35-7,5 S 2M	8015393407	40
DR 35-15 S 2M	8015393427	20
SS 1	8010097308	50
SS 2	8010097318	50
PS 1	8010197328	50
PS 2	8010197420	50
EPL TBL 2,5-10	8012396118	50
PR TBL 2,5 - 10	8012396408	50
SPR 2,5-10	8012396528	100
SCC 4/2	8013095123	50
SCC 4/3	8013095133	50
SCC 4/10	8013095103	10
TCC 4/2	8013094323	50
TCC 4/3	8013094333	50
TCC 4/10	8013094303	10
TST 1	8014393227	50
MTG 6,4	8020387009	500
TBSL 5,15x5	8020384011	1
GM1	8014393008	50
GM2	8014393018	50
TM1	8014393020	50
0,5x3,0		

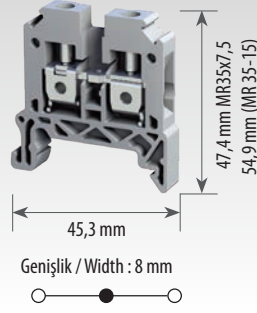
TBL 6**TBL 6**

8000099038

80

800 V / 41 A

6

0,5 - 10

0,5 - 10

0,5 - 6

20-8 AWG

12

1,2

M3,5

8

3 / III / I

Ürün Adı Product Name	Sipariş No Order No.	Adet Qty.
DR 35-7,5 S 2M	8015393407	40
DR 35-15 S 2M	8015393427	20
SS 1	8010097308	50
SS 2	8010097318	50
PS 1	8010197328	50
PS 2	8010197420	50
EPL TBL 2,5-10	8012396118	50
PR TBL 2,5 - 10	8012396408	50
SPR 2,5-10	8012396528	100
SCC 6/2	8013095223	50
SCC 6/3	8013095233	50
SCC 6/10	8013095203	10
TST-I 1	8014393108	50
MTG 8	8020386009	500
TBSL 5,15x5	8020384011	1
GM1	8014393008	50
GM2	8014393018	50
TM1	8014393020	50
0,6x3,5		

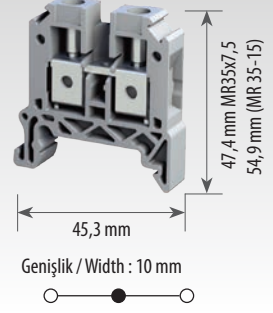
TBL 10**TBL 10**

8000099048

60

800 V / 57 A

10

0,5 - 16

0,5 - 16

0,5 - 10

20-6 AWG

12

1,5

M4

8

3 / III / I

Ürün Adı Product Name	Sipariş No Order No.	Adet Qty.
DR 35-7,5 S 2M	8015393407	40
DR 35-15 S 2M	8015393427	20
SS 1	8010097308	50
SS 2	8010097318	50
PS 1	8010197328	50
PS 2	8010197420	50
EPL TBL 2,5-10	8012396118	50
PR TBL 2,5 - 10	8012396408	50
SPR 2,5-10	8012396528	100
SCC 10/2	8013095323	50
SCC 10/3	8013095333	50
SCC 10/10	8013095303	10
TST-I 1	8014393108	50
MTG 10	8020385009	250
TBSL 5,15x5	8020384011	1
GM1	8014393008	50
GM2	8014393018	50
TM1	8014393020	50
0,6x3,5		

* TM1 Sadece PS2 ürünü ile Uyumludur.

* TM1 is only suitable for PS2

Vida Bağlantılı Ray Klemensleri Screw Type Terminal Blocks

TBL Serisi Geçiş Klemensleri

TBL Series Feed Through Terminal Block



Ürün Adı / Product Name

Sipariş No / Order No.

Paket Adeti / Packing Qty.

Anma Değerleri / Rated Values

IEC 60947-7-1

Bağlantı Bilgileri / Connection Information

Kesit / Cross-Section (mm²)

Tek Damarlı Kablo / Solid Conductor Cross-Section min mm²: (mm²)-(min-max)

Çok Damarlı Kablo / Stranded Conductor Cross-Section (mm²)-(min-max)

Çok Tellili Kablo / Flexible Conductor Cross-Section (mm²)-(min-max)

AWG

Açıklamalar / Descriptions

Kablo Soyma Uzunluğu / Insulation Stripping Length (mm)

Max. Sıkma Torku (N.m) / Max. Tightening Torque

Bağlantı Vidası / Screw Diameter

Darbe Gerilimi / Rated Impulse Voltage (Kv)

Kirlilik Derecesi / Gerilim Kategorisi / Malzeme Grubu / Pollution Degree / Voltage Category / Material Group

Aksesuarlar / Accessories

Montaj Rayı / Din Rail

Durdurucu / End Stopper

Ayırma Plakası / Partition Plate

Üst Köprü / Cross Connection

Test Fişi / Test Plug

Klemens Etiketi / Marking Tags

Grup Etiketi / Group Label

Tornavida / Screwdriver

* TM1 Sadece PS2 ürünü ile Uyumludur.

* TM1 is only suitable for PS2

Renk Kodları / Color Codes

800009900....

...0

...1

...2

...3

...4

...5

...6

...9

TBL 16

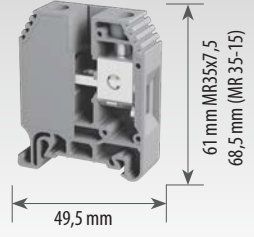

Genişlik / Width : 12,5 mm



TBL 16

8000099058

50

1000 V / 76 A

16

0,5 - 16

0,5 - 16

0,5 - 16

20-6 AWG

12,3

2,5

M5

8

3 / III / I

Ürün Adı Product Name	Sipariş No Order No.	Adet Qty.
DR 35-7,5 S 2M	8015393407	40
DR 35-15 S 2M	8015393427	20
SS 1	8010097308	50
SS 2	8010097318	50
PS 1	8010197328	50
PS 2	8010197420	50
GPR	8012396568	20
SCC 16/2	8013095423	20
SCC 16/3	8013095433	20
SCC 16/10	8013095403	10
TST-1 1	8014393108	50
TST 2	8014393237	10
MTG 10	8020385009	250
GM1	8014393008	50
GM2	8014393018	50
TM1	8014393020	50
1,0x5,5		

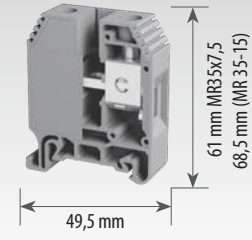
TBL 25

Genişlik / Width : 13,6 mm

**TBL 25**

8000099068

50

1000 V / 101 A

25

0,5 - 25

0,5 - 25

0,5 - 25

20-4 AWG

12,3

2,5

M5

8

3 / III / I

Ürün Adı Product Name	Sipariş No Order No.	Adet Qty.
DR 35-7,5 S 2M	8015393407	40
DR 35-15 S 2M	8015393427	20
SS 1	8010097308	50
SS 2	8010097318	50
PS 1	8010197328	50
PS 2	8010197420	50
GPR	8012396568	20
SCC 25/2	8013095523	20
SCC 25/3	8013095533	20
SCC 25/10	8013095503	10
TST-I 1	8014393108	10
TST 2	8014393237	10
MTG 10	8020385009	250
GM1	8014393008	50
GM2	8014393018	50
TM1	8014393020	50
1,0x5,5		

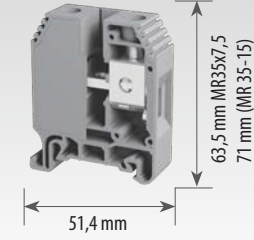
TBL 35

Genişlik / Width : 16,5 mm

**TBL 35**

8000099078

20

1000 V / 125 A

35

1,5 - 35

1,5 - 35

1,5 - 35

16-2 AWG

14,9

3,5

M6

8

3 / III / I

Ürün Adı Product Name	Sipariş No Order No.	Adet Qty.
DR 35-7,5 S 2M	8015393407	40
DR 35-15 S 2M	8015393427	20
SS 1	8010097308	50
SS 2	8010097318	50
PS 1	8010197328	50
PS 2	8010197420	50
GPR	8012396568	20
SCC 35/2	8013095623	20
SCC 35/3	8013095633	20
SCC 35/10	8013095603	10
TST 4	8014393257	50
MTG 10	8020385009	250
GM1	8014393008	50
GM2	8014393018	50
TM1	8014393020	50
1,2x6,5		

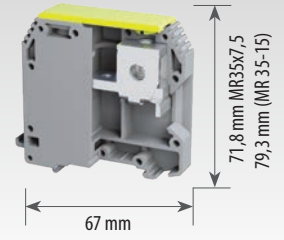
TBL 50

Genişlik / Width : 20,1 mm

**TBL 50**

8000099088

20

1000 V / 150 A

50

6 - 50

6 - 50

10 - 50

10-0 AWG

19

8

M8

8

3 / III / I

Ürün Adı Product Name	Sipariş No Order No.	Adet Qty.
DR 35-7,5 S 2M	8015393407	40
DR 35-15 S 2M	8015393427	20
SS 1	8010097308	50
SS 2	8010097318	50
PS 1	8010197328	50
PS 2	8010197420	50
GPR	8012396568	20
SCC 50/2	8013095723	10
SCC 50/3	8013095733	10
MTG 10	8020385009	250
GM1	8014393008	50
GM2	8014393018	50
TM1	8014393020	50
Alyen / Allen Wrench 4		

* TM1 Sadece PS2 ürünü ile Uyumludur.

* TM1 is only suitable for PS2

Vida Bağlantılı Ray Klemensleri Screw Type Terminal Blocks

TBL Serisi Geçiş Klemensleri

TBL Series Feed Through Terminal Block



Ürün Adı / Product Name

Sipariş No / Order No.

Paket Adeti / Packing Qty.

Anma Değerleri / Rated Values

IEC 60947-7-1

Bağlantı Bilgileri / Connection Information

Kesit / Cross-Section (mm²)

Tek Damarlı Kablo / Solid Conductor Cross-Section min mm²: (mm²)-(min-max)

Çok Damarlı Kablo / Stranded Conductor Cross-Section (mm²)-(min-max)

Çok Tellî Kablo / Flexible Conductor Cross-Section (mm²)-(min-max)

AWG

Açıklamalar / Descriptions

Kablo Soyma Uzunluğu / Insulation Stripping Length (mm)

Max. Sıkma Torku (N.m) / Max. Tightening Torque

Bağlantı Vidası / Screw Diameter

Darbe Gerilimi / Rated Impulse Voltage (Kv)

Kirlilik Derecesi / Gerilim Kategorisi / Malzeme Grubu / Pollution Degree / Voltage Category / Material Group

Aksesuarlar / Accessories

Montaj Rayı / Din Rail

Durdurucu / End Stopper

Üst Köprü / Cross Connection

Klemens Etiketleri / Marking Tags

Grup Etiketleri / Group Label

Alyen / Allen Wrench

* **TM1 Sadece PS2 ürünü ile Uyumludur.**

* TM1 is only suitable for PS2

TBL 70

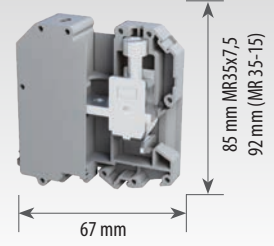

Genişlik / Width : 22 mm



TBL 70

8000099098

10

1000 V / 192 A

70

6 - 70

6 - 70

10 - 70

8-0 AWG

19

10

M8

8

3 / III / I

Ürün Adı Product Name	Sipariş No Order No.	Adet Qty.
DR 35-7,5 S 2M	8015393407	40
DR 35-15 S 2M	8015393427	20
SS 1	8010097308	50
SS 2	8010097318	50
PS 1	8010197328	50
PS 2	8010197420	50
SCC 70/2	8013095823	10
SCC 70 /3	8013095833	10
MTG 10	8020385009	250
GM1	8014393008	50
GM2	8014393018	50
TM1	8014393020	50
6		

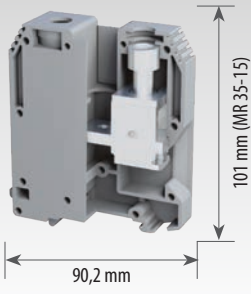
TBL 95

Genişlik / Width : 25,3 mm

**TBL 95**

8000099108

5

1000 V / 232 A

95

6 - 95

6 - 95

10 - 95

10-3/0 AWG

24.5

14

M8

8

3 / III / I

Ürün Adı Product Name	Sipariş No Order No.	Adet Qty.
DR 35-7,5 S 2M	8015393407	40
DR 35-15 S 2M	8015393427	20
SS 1	8010097308	50
SS 2	8010097318	50
PS 1	8010197328	50
PS 2	8010197420	50
SCC 95/2	8013095923	10
SCC 95/3	8013095933	10
MTG 10	8020385009	250
GM1	8014393008	50
GM2	8014393018	50
TM1	8014393020	50
6		

* TM1 Sadece PS2 ürünü ile Uyumludur.

* TM1 is only suitable for PS2

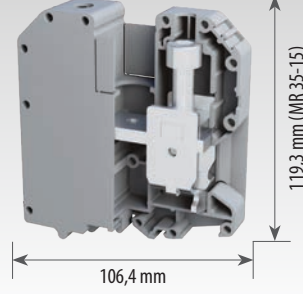
TBL 150

Genişlik / Width : 31 mm

**TBL 150**

8000099118

5

1000 V / 309 A

150

6 - 150

6 - 150

10 - 150

10-300 kcmil

27

22

M10

8

3 / III / I

Ürün Adı Product Name	Sipariş No Order No.	Adet Qty.
DR 35-7,5 S 2M	8015393407	40
DR 35-15 S 2M	8015393427	20
SS 1	8010097308	50
SS 2	8010097318	50
PS 1	8010197328	50
PS 2	8010197420	50
SCC 150/2	8013094023	10
MTG 10	8020385009	250
GM1	8014393008	50
GM2	8014393018	50
TM1	8014393020	50
8		

Vida Bağlantılı Ray Klemensleri Screw Type Terminal Blocks

Yüksek Akım Klemensi High Current Terminal Blocks



Ürün Adı / Product Name

Sipariş No / Order No.

Paket Adeti / Packing Qty.

Anma Değerleri / Rated Values

IEC 60947-7-1

Bağlantı Bilgileri / Connection Information

Kesit / Cross-Section (mm²)

Delik Çapı ve Bara Ölçüsü (mm) / Hole Diameter & Power Rail

DIN 46234 Norm Pabuç (min-max) (mm²) / Cable Lugs DIN 46234

DIN 46235 Norm Pabuç (min-max) (mm²) / Cable Lugs DIN 46235

AWG Kesit Aralığı DIN 46234 / AWG

AWG Kesit Aralığı DIN 46235 / AWG

Açıklamalar / Descriptions

Max. Sıkma Torku (N.m) / Max. Tightening Torque

Bağlantı Vidası / Screw Diameter

Darbe Gerilimi / Rated Impulse Voltage (kV)

Kirlilik Derecesi / Gerilim Kategorisi / Malzeme Grubu / Pollution Degree / Voltage Category / Material Group

Aksesuarlar / Accessories

Montaj Rayı / Din Rail

Koruma Kapağı / Isolation Cover

Durdurucu / End Stopper

Klemens Etiketleri / Marking Tags

Grup Etiketleri / Group Label

* **TM1 Sadece PS2 ürünü ile Uyumludur.**

* TM1 is only suitable for PS2

** **Koruma kapakları ayrı satılmaktadır. (C-TBB)**

** Isolation covers are sold separately. (C-TBB)

TBB 70

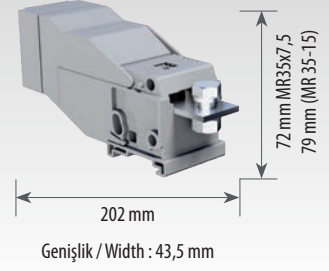

TBB 70

8000099128

5

1000 V / 192 A

70

9/25x3

2,5 - 70

16 - 70

14-2/0

6-2/0

15-20

M8

8

3 / III / I

Ürün Adı Product Name	Sipariş No Order No.	Adet Qty.
DR 35-7,5 S 2M	8015393407	40
DR 35-15 S 2M	8015393427	20
C-TBB 70-95-150	8012396608	10
SS 1	8010097308	50
SS 2	8010097318	50
PS 1	8010197328	50
PS 2	8010197420	50
MTG 5	8020389009	500
GM1	8014393008	50
GM2	8014393018	50
TM1	8014393020	50

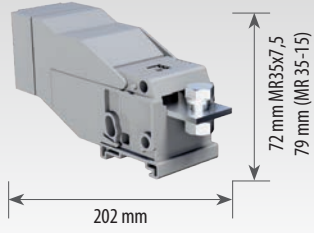
TBB 95

Genişlik / Width : 43,5 mm

**TBB 95**

8000099138

5

1000 V / 232 A

95

11/25x5

6 - 95

16 - 95

10-3/0

6-3/0

25-30

M10

8

3 / III / I

Ürün Adı Product Name	Sipariş No Order No.	Adet Qty.
DR 35-7,5 S 2M	8015393407	40
DR 35-15 S 2M	8015393427	20
C-TBB 70-95-150	8012396608	10
SS 1	8010097308	50
SS 2	8010097318	50
PS 1	8010197328	50
PS 2	8010197420	50
MTG 5	8020389009	500
GM1	8014393008	50
GM2	8014393018	50
TM1	8014393020	50

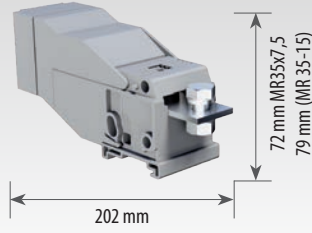
TBB 150

Genişlik / Width : 43,5 mm

**TBB 150**

8000099148

5

1000 V / 309 A

150

13/30x5

10 - 150

25 - 150

8-300 Kcmil

4-300 Kcmil

25-30

M12

8

3 / III / I

Ürün Adı Product Name	Sipariş No Order No.	Adet Qty.
DR 35-7,5 S 2M	8015393407	40
DR 35-15 S 2M	8015393427	20
C-TBB 70-95-150	8012396608	10
SS 1	8010097308	50
SS 2	8010097318	50
PS 1	8010197328	50
PS 2	8010197420	50
MTG 5	8020389009	500
GM1	8014393008	50
GM2	8014393018	50
TM1	8014393020	50

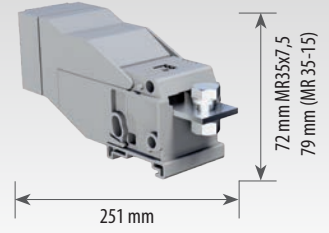
TBB 240

Genişlik / Width : 46,0 mm

**TBB 240**

8000099158

4

1000 V / 415 A

240

17/29,7x9,7

25 - 240

50 - 185

4-500 Kcmil

0-350 Kcmil

30-35

M16

8

3 / III / I

Ürün Adı Product Name	Sipariş No Order No.	Adet Qty.
DR 35-7,5 S 2M	8015393407	40
DR 35-15 S 2M	8015393427	20
C-TBB 240	8012396618	8
SS 1	8010097308	50
SS 2	8010097318	50
PS 1	8010197328	50
PS 2	8010197420	50
MTG 5	8020389009	500
GM1	8014393008	50
GM2	8014393018	50
TM1	8014393020	50

* TM1 Sadece PS2 ürünü ile Uyumludur.

* TM1 is only suitable for PS2

Vida Bağlantılı Ray Klemensleri Screw Type Terminal Blocks

Topraklama Klemensleri Earth Terminal Blocks



Ürün Adı / Product Name

Sipariş No / Order No.

Paket Adeti / Packing Qty.

Anma Değerleri / Rated Values

IEC 60947-7-1

Bağlantı Bilgileri / Connection Information

Kesit / Cross-Section (mm²)

Tek Damarlı Kablo / Solid Conductor Cross-Section min mm²: (mm²)-(min-max)

Çok Damarlı Kablo / Stranded Conductor Cross-Section (mm²)-(min-max)

Çok Tellî Kablo / Flexible Conductor Cross-Section (mm²)-(min-max)

AWG

Açıklamalar / Descriptions

Kablo Soyma Uzunluğu / Insulation Stripping Length (mm)

Max. Sıkma Torkü (N.m) / Max. Tightening Torque

Bağlantı Vidası / Screw Diameter

Darbe Gerilimi / Rated Impulse Voltage (kV)

Kirlilik Derecesi / Gerilim Kategorisi / Malzeme Grubu / Pollution Degree / Voltage Category / Material Group

Aksesuarlar / Accessories

Montaj Rayı / Din Rail

Durdurucu / End Stopper

Nihayet Plakası / End Plate

Klemens Etiketleri / Marking Tags

Grup Etiketleri / Group Label

Tornavida / Screwdriver

* **TM1 Sadece PS2 ürünü ile Uyumludur.**

* TM1 is only suitable for PS2

NTT 2,5 E

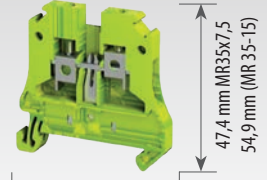

48,3 mm

Genişlik / Width : 6,0 mm

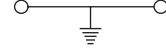

NTT 2,5 E

8001099214

50

2,5

0,5 - 4

0,5 - 4

0,5 - 2,5

20-12 AWG

10

0,6

M2,5

6

3 / III / I

Ürün Adı Product Name	Sipariş No Order No.	Adet Qty.
DR 35-7,5 S 2M	8015393407	40
DR 35-15 S 2M	8015393427	20
SS 1	8010097308	50
SS 2	8010097318	50
PS 1	8010197328	50
PS 2	8010197420	50
EPL TBL 2,5-10	8012396118	50
MTG 6	8020388009	500
GM1	8014393008	50
GM2	8014393018	50
TM1	8014393020	50
0,5x3,0		

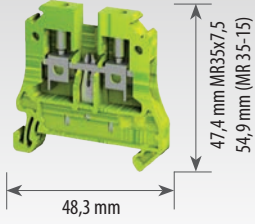
NTT 4 E

Genişlik / Width : 6,4 mm

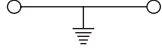
**NTT 4 E**

8001099224

50

4

0,5 - 4

0,5 - 4

0,5 - 4

20-12 AWG

12

0,8

M3

6

3 / III / I

Ürün Adı Product Name	Sipariş No Order No.	Adet Qty.
DR 35-7,5 S 2M	8015393407	40
DR 35-15 S 2M	8015393427	20
SS 1	8010097308	50
SS 2	8010097318	50
PS 1	8010197328	50
PS 2	8010197420	50
EPL TBL 2,5-10	8012396118	50
MTG 6,4	8020387009	500
GM1	8014393008	50
GM2	8014393018	50
TM1	8014393020	50
0,5x3,0		

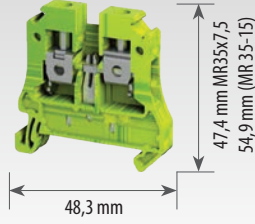
NTT 6 E

Genişlik / Width : 8,0 mm

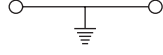
**NTT 6 E**

8001099234

25

6

0,5 - 10

0,5 - 10

0,5 - 6

20-8 AWG

12

1,2

M4

8

3 / III / I

Ürün Adı Product Name	Sipariş No Order No.	Adet Qty.
DR 35-7,5 S 2M	8015393407	40
DR 35-15 S 2M	8015393427	20
SS 1	8010097308	50
SS 2	8010097318	50
PS 1	8010197328	50
PS 2	8010197420	50
EPL TBL 2,5-10	8012396118	50
MTG 8	8020386009	500
GM1	8014393008	50
GM2	8014393018	50
TM1	8014393020	50
1,0x5,5		

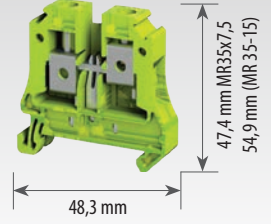
NTT 10 E

Genişlik / Width : 10,0 mm

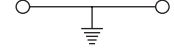
**NTT 10 E**

8001099244

20

10

0,5 - 16

0,5 - 16

0,5 - 10

20-6 AWG

12

1,5

M6

8

3 / III / I

Ürün Adı Product Name	Sipariş No Order No.	Adet Qty.
DR 35-7,5 S 2M	8015393407	40
DR 35-15 S 2M	8015393427	20
SS 1	8010097308	50
SS 2	8010097318	50
PS 1	8010197328	50
PS 2	8010197420	50
EPL TBL 2,5-10	8012396118	50
MTG 10	8020385009	250
GM1	8014393008	50
GM2	8014393018	50
TM1	8014393020	50
1,0x5,5		

*TM1 Sadece PS2 ürünü ile Uyumludur.

*TM1 is only suitable for PS2

Vida Bağlantılı Ray Klemensleri Screw Type Terminal Blocks

Topraklama Klemensleri Earth Terminal Blocks



Ürün Adı / Product Name

Sipariş No / Order No.

Paket Adeti / Packing Qty.

Anma Değerleri / Rated Values

IEC 60947-7-1

Bağlantı Bilgileri / Connection Information

Kesit / Cross-Section (mm²)

Tek Damarlı Kablo / Solid Conductor Cross-Section min mm²: (mm²)-(min-max)

Çok Damarlı Kablo / Stranded Conductor Cross-Section (mm²)-(min-max)

Çok Tellî Kablo / Flexible Conductor Cross-Section (mm²)-(min-max)

AWG

Açıklamalar / Descriptions

Kablo Soyma Uzunluğu / Insulation Stripping Length (mm)

Max. Sıkma Torku (N.m) / Max. Tightening Torque

Bağlantı Vidası / Screw Diameter

Darbe Gerilimi / Rated Impulse Voltage (kV)

Kirlilik Derecesi / Gerilim Kategorisi / Malzeme Grubu / Pollution Degree / Voltage Category / Material Group

Aksesuarlar / Accessories

Montaj Rayı / Din Rail

Durdurucu / End Stopper

Ayırma Plakası / Partition Plate

Klemens Etiketleri / Marking Tags

Grup Etiketleri / Group Label

Tornavida / Screwdriver

* **TM1 Sadece PS2 ürünü ile Uyumludur.**

* TM1 is only suitable for PS2

TBL 16 E

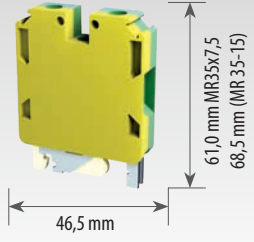

Genişlik / Width : 12,5 mm

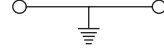

TBL 16 E

8001099194

20

16

0,5 - 16

0,5 - 16

0,5 - 16

20-6 AWG

12,3

1,2

M5

8

3 / III / I

Ürün Adı Product Name	Sipariş No Order No.	Adet Qty.
DR 35-7,5 S 2M	8015393407	40
DR 35-15 S 2M	8015393427	20
SS 1	8010097308	50
SS 2	8010097318	50
PS 1	8010197328	50
PS 2	8010197420	50
GPR	8012396568	20
MTG 10	8020385009	250
GM1	8014393008	50
GM2	8014393018	50
TM1	8014393020	50
1,0x5,5		

TBL 35 E

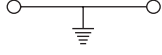
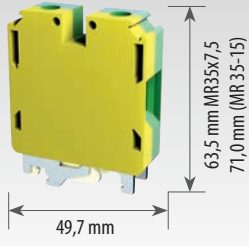

TBL 35 E

8001099204

20

35

1,5 - 35

1,5 - 35

1,5 - 35

16-2 AWG

14,9

3,5

M6

8

3 / III / I

Ürün Adı Product Name	Sipariş No Order No.	Adet Qty.
DR 35-7,5 S 2M	8015393407	40
DR 35-15 S 2M	8015393427	20
SS 1	8010097308	50
SS 2	8010097318	50
PS 1	8010197328	50
PS 2	8010197420	50
GPR	8012396568	20
MTG 10	8020385009	250
GM1	8014393008	50
GM2	8014393018	50
TM1	8014393020	50
1,2x6,5		

* **TM1 Sadece PS2 ürünü ile Uyumludur.**

* TM1 is only suitable for PS2

Vida Bağlantılı Ray Klemensleri Screw Type Terminal Blocks

Çok Katlı Klemensler Multilevel Terminal Blocks



Ürün Adı / Product Name

Sipariş No / Order No.

Paket Adeti / Packing Qty.

Anma Değerleri / Rated Values

IEC 60947-7-1

Bağlantı Bilgileri / Connection Information

Kesit / Cross-Section (mm²)

Tek Damarlı Kablo / Solid Conductor Cross-Section min mm²: (mm²)-(min-max)

Çok Damarlı Kablo / Stranded Conductor Cross-Section (mm²)-(min-max)

Çok Tellî Kablo / Flexible Conductor Cross-Section (mm²)-(min-max)

AWG

Açıklamalar / Descriptions

Kablo Soyma Uzunluğu / Insulation Stripping Length (mm)

Max. Sıkma Torku (N.m) / Max. Tightening Torque

Bağlantı Vidası / Screw Diameter

Darbe Gerilimi / Rated Impulse Voltage (Kv)

Kirlilik Derecesi / Gerilim Kategorisi / Malzeme Grubu / Pollution Degree / Voltage Category / Material Group

Aksesuarlar / Accessories

Montaj Rayı / Din Rail

Durdurucu / End Stopper

Nihayet Plakası / End Plate

Ayırma Plakası / Partition Plate

Mini Ayırma Dili / Small Partition Plate

Üst Köprü / Cross Connection

Tarak Köprü / Comb Connector

Test Fişi / Test Plug

Klemens Etiketi / Marking Tags

Grup Etiketi / Group Label

Tornavida / Screwdriver

* **TM1 Sadece PS2 ürünü ile Uyumludur.**

* TM1 is only suitable for PS2

TBL 2,5-4 2P



TBL 2,5-4 2P

8002099438

50

500 V / 32 A

2,5 - 4

0,5 - 4

0,5 - 4

0,5 - 4

20-12 AWG

9

0,4

M2,5

6

3 / III / I

Ürün Adı Product Name	Sipariş No Order No.	Adet Qty.
DR 35-7,5 S 2M	8015393407	40
DR 35-15 S 2M	8015393427	20
SS 1	8010097308	50
SS 2	8010097318	50
PS 1	8010197328	50
PS 2	8010197420	50
EPL TBL 2,5-4 2P	8012396208	20
GPR	8012396568	20
SCC 2,5/2	8013095023	50
SCC 2,5/3	8013095033	50
SCC 2,5/10	8013095003	10
TCC 2,5/2	8013094223	50
TCC 2,5/3	8013094203	50
TCC 2,5/10	8013094233	10
TST 1	8014393227	50
MTG 6	8020388009	500
GM1	8014393008	50
GM2	8014393018	50
TM1	8014393020	50
0,5x3,0		

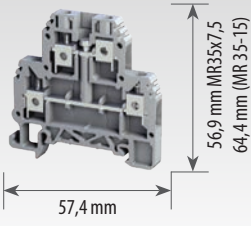
TBL 2,5-4 2PK

Genişlik / Width : 6,0 mm

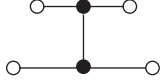
**TBL 2,5-4 2PK**

8002099448

50

500 V / 32 A

2,5 - 4

0,5 - 4

0,5 - 4

0,5 - 4

20-12 AWG

9

0,4

M2,5

6

3 / III / I

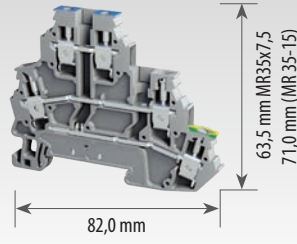
TBL 2,5 - 2P+E

Genişlik / Width : 6 mm

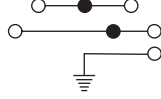
**TBL 2,5 - 2P+E**

8002099158

35

400 V / 24 A

2,5

0,5 - 4

0,5 - 4

0,5 - 4

20-12 AWG

9

0,4

M2,5

6

3 / III / I

Ürün Adı Product Name	Sipariş No Order No.	Adet Qty.
DR 35-7,5 S 2M	8015393407	40
DR 35-15 S 2M	8015393427	20
SS 1	8010097308	50
SS 2	8010097318	50
PS 1	8010197328	50
PS 2	8010197420	50
EPL TBL 2,5-4 2P	8012396208	20
GPR	8012396568	20
TCC 2,5/2	8013094223	50
TCC 2,5/3	8013094203	50
TCC 2,5/10	8013094233	10
TST 1	8014393227	50
MTG 6	8020388009	500
GM1	8014393008	50
GM2	8014393018	50
TM1	8014393020	50
0,5x3,0		

Ürün Adı Product Name	Sipariş No Order No.	Adet Qty.
DR 35-7,5 S 2M	8015393407	40
DR 35-15 S 2M	8015393427	20
SS 1	8010097308	50
SS 2	8010097318	50
PS 1	8010197328	50
PS 2	8010197420	50
EPL TBL 2,5 2P+E	8012396158	20
PR TBL 4 2P	8012396508	20
SPR TBL 4 2P	8012396558	100
SCC 2,5/2	8013095023	50
SCC 2,5/3	8013095033	50
SCC 2,5/10	8013095003	10
TCC 2,5/2	8013094223	50
TCC 2,5/3	8013094203	50
TCC 2,5/10	8013094233	10
TST 1	8014393227	50
MTG 6	8020388009	500
GM1	8014393008	50
GM2	8014393018	50
TM1	8014393020	50
0,5x3,0		

* TM1 Sadece PS2 ürünü ile Uyumludur.

* TM1 is only suitable for PS2

Vida Bağlantılı Ray Klemensleri Screw Type Terminal Blocks

Çok Katlı Klemensler Multilevel Terminal Blocks



Ürün Adı / Product Name
Sipariş No / Order No.
Paket Adeti / Packing Qty.
Anma Değerleri / Rated Values
IEC 60947-7-1
Bağlantı Bilgileri / Connection Information
Kesit / Cross-Section (mm²)
Tek Damarlı Kablo / Solid Conductor Cross-Section min mm²: (mm²)-(min-max)
Çok Damarlı Kablo / Stranded Conductor Cross-Section (mm²)-(min-max)
Çok Telli Kablo / Flexible Conductor Cross-Section (mm²)-(min-max)
AWG
Açıklamalar / Descriptions
Kablo Soyma Uzunluğu / Insulation Stripping Length (mm)
Sıkma Torku (N.m) / Tightening Torque
Bağlantı Vidası / Screw Diameter
Darbe Gerilimi / Rated Impulse Voltage (Kv)
Kirlilik Derecesi / Gerilim Kategorisi / Malzeme Grubu / Pollution Degree / Voltage Category / Material Group
Aksesuarlar / Accessories
Montaj Rayı / Din Rail
Durdurucu / End Stopper
Nihayet Plakası / End Plate
Ayırma Plakası / Partition Plate
Üst Köprü / Cross Connection
Tarak Köprü / Comb Connector
Test Fişi / Test Plug
Klemens Etiketi / Marking Tags
Grup Etiketi / Group Label
Tornavida / Screwdriver

* TM1 Sadece PS2 ürünü ile uyumludur.

* TM1 is only suitable for PS2

TBL 4 2P

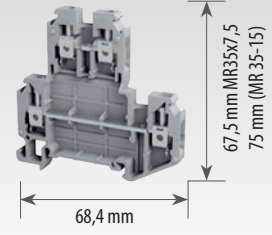

Genişlik / Width : 6,4 mm



TBL 4 2P

8002099258

50

500 V / 32 A

4

0,5 - 4

0,5 - 4

0,5 - 4

20-12 AWG

9

0,4

M2,5

6

3 / III / I

Ürün Adı Product Name	Sipariş No Order No.	Adet Qty.
DR 35-7,5 S 2M	8015393407	40
DR 35-15 S 2M	8015393427	20
SS 1	8010097308	50
SS 2	8010097318	50
PS 1	8010197328	50
PS 2	8010197420	50
EPL1 TBL 4 2P	8012396218	20
EPL2 TBL 4 2P	8012396228	20
GPR	8012396568	20
SCC 4/2 TBL 4 2P	8013094123	50
SCC 4/3 TBL 4 2P	8013094133	50
SCC 4/10 TBL 4 2P	8013094103	10
TCC 4/2	8013094323	50
TCC 4/3	8013094333	50
TCC 4/10	8013094303	10
TST 1	8014393227	50
MTG 6,4	8020387009	500
GM1	8014393008	50
GM2	8014393018	50
TM1	8014393020	50
0,5x3,0		

TBL 4 2P

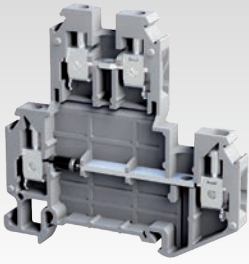

8002099268
TBL 4 2P X1

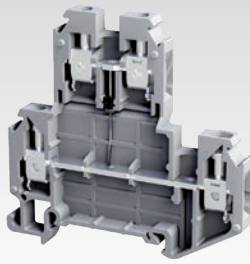

8002099278
TBL 4 2P X2

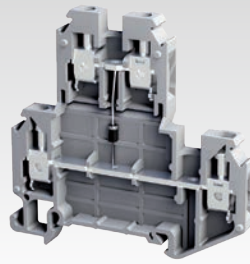

8002099288
TBL 4 2P X3

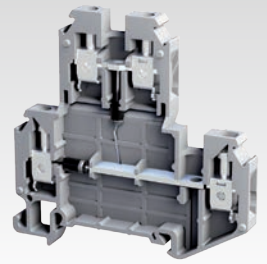

8002099298
TBL 4 2P X4

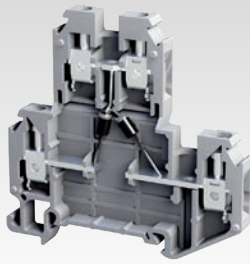

8002099318
TBL 4 2P X5

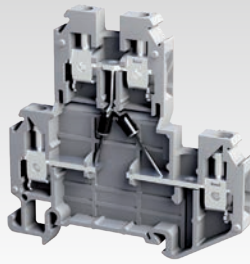

8002099328
TBL 4 2P X6

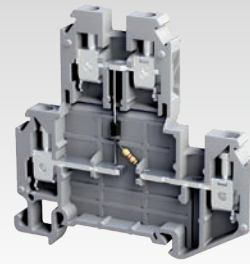

8002099348
TBL 4 2P X8

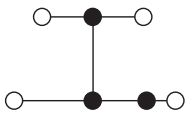

8002099428
TBL 4 2PK

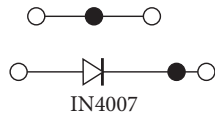

8002099268
TBL 4 2P X1

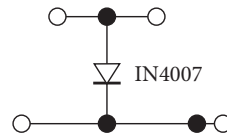

8002099278
TBL 4 2P X2

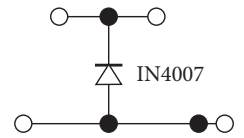

8002099288
TBL 4 2P X3

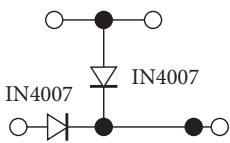

8002099298
TBL 4 2P X4

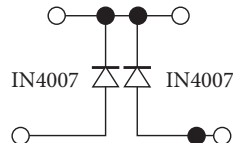

8002099305 TBL 4 2P X5
8002099318 TBL 4 2P X5

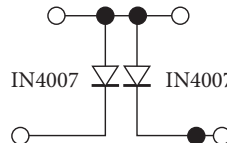

8002099328
TBL 4 2P X6

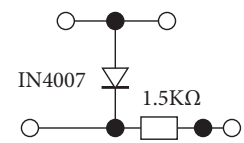

8002099348
TBL 4 2P X8

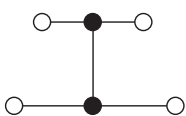

8002099448
TBL 2,5-4 2PK

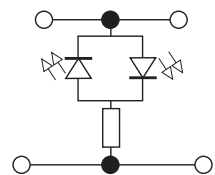

8002099458
TBL 2,5-4 2PL (24-48VAC/DC)
8002099468
TBL 2,5-4 2PL (110-220VAC/DC)

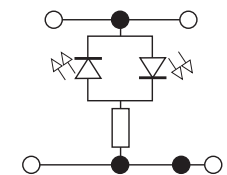

8002099368
TBL 4 2PL (24-48VAC/DC)
8002099378
TBL 4 2PL (110-220VAC/DC)

Vida Bağlantılı Ray Klemensleri Screw Type Terminal Blocks

Çok Katlı Klemensler Multilevel Terminal Blocks



Ürün Adı / Product Name
Sipariş No / Order No.
Paket Adeti / Packing Qty.
Anma Değerleri / Rated Values
IEC 60947-7-1
Bağlantı Bilgileri / Connection Information
Kesit / Cross-Section (mm²)
Tek Damarlı Kablo / Solid Conductor Cross-Section min mm²: (mm²)-(min-max)
Çok Damarlı Kablo / Stranded Conductor Cross-Section (mm²)-(min-max)
Çok Telli Kablo / Flexible Conductor Cross-Section (mm²)-(min-max)
AWG
Açıklamalar / Descriptions
Kablo Soyma Uzunluğu / Insulation Stripping Length (mm)
Sıkma Torku (N.m) / Tightening Torque
Bağlantı Vidası / Screw Diameter
Darbe Gerilimi / Rated Impulse Voltage (Kv)
Kirlilik Derecesi / Gerilim Kategorisi / Malzeme Grubu / Pollution Degree / Voltage Category / Material Group
Aksesuarlar / Accessories
Montaj Rayı / Din Rail
Durdurucu / End Stopper
Nihayet Plakası / End Plate
Ayırma Plakası / Partition Plate
Üst Köprü / Cross Connection
Tarak Köprü / Comb Connector
Test Fişi / Test Plug
Klemens Etiketi / Marking Tags
Grup Etiketi / Group Label
Tornavida / Screwdriver

TBL 4 2PK

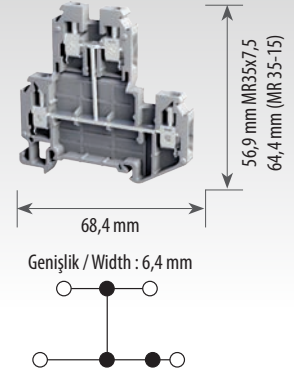

TBL 4 2PK		
8002099428		
25		
500 V / 32 A		
4		
0,5 - 4		
0,5 - 4		
0,5 - 4		
20-12 AWG		
9		
0,4		
M2,5		
6		
3 / III / I		
DR 35-7,5 S 2M	8015393407	40
DR 35-15 S 2M	8015393427	20
SS 1	8010097308	50
SS 2	8010097318	50
PS 1	8010197328	50
PS 2	8010197420	50
EPL1 TBL 4 2P	8012396218	20
EPL2 TBL 4 2P	8012396228	20
EPL3 TBL 4 2P	8012396238	20
GPR	8012396568	20
SCC 4/2 TBL 4 2P	8013094123	50
SCC 4/3 TBL 4 2P	8013094133	50
SCC 4/10 TBL 4 2P	8013094103	10
TCC 4/2	8013094323	50
TCC 4/3	8013094333	50
TCC 4/10	8013094303	10
TST 1	8014393227	50
MTG 6,4	8020387009	500
GM1	8014393008	50
GM2	8014393018	50
TM1	8014393020	50
0,5x3,0		

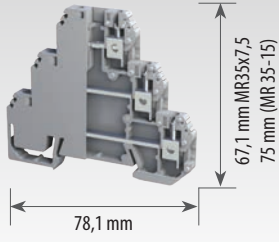
TBL 4 3P

Genişlik / Width : 6,4 mm

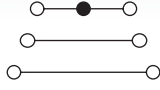
**TBL 4 3P**

8002099478

25

400 V / 32 A

4

0,5 - 4

0,5 - 4

0,5 - 4

20-12 AWG

9

0,4

M2,5

6

3 / III / I

Ürün Adı Product Name	Sipariş No Order No.	Adet Qty.
DR 35-7,5 S 2M	8015393407	40
DR 35-15 S 2M	8015393427	20
SS 1	8010097308	50
SS 2	8010097318	50
PS 1	8010197328	50
PS 2	8010197420	50
GPR	8012396568	20
SCC 4/2 TBL 4 2P	8013094123	50
SCC 4/3 TBL 4 2P	8013094133	50
SCC 4/10 TBL 4 2P	8013094103	10
TST 1	8014393227	50
MTG 6,4	8020387009	500
GM1	8014393008	50
GM2	8014393018	50
TM1	8014393020	50
0,5x3,0		

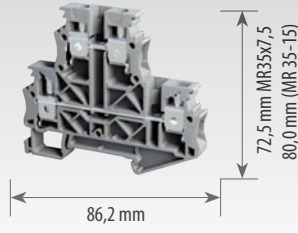
TBL 10 - 2P

Genişlik / Width : 10 mm

**TBL 10 - 2P**

8002099488

25

800 V / 57 A

10

0,5 - 4

0,5 - 4

0,5 - 4

20-12 AWG

9

1,5 - 1,8

M2,5

6

3 / III / I

Ürün Adı Product Name	Sipariş No Order No.	Adet Qty.
DR 35-7,5 S 2M	8015393407	40
DR 35-15 S 2M	8015393427	20
SS 1	8010097308	50
SS 2	8010097318	50
PS 1	8010197328	50
PS 2	8010197420	50
EPL TBL 10 2P	8012396298	20
GPR	8012396568	20
SCC 10/2	8013095323	50
SCC 10/3	8013095333	50
SCC 10/10	8013095303	10
TST 1	8014393227	50
MTG 10	8020385009	250
GM1	8014393008	50
GM2	8014393018	50
TM1	8014393020	50
0,5x3,0		

* TM1 Sadece PS2 ürünü ile Uyumludur.

* TM1 is only suitable for PS2

Vida Bağlantılı Ray Klemensleri Screw Type Terminal Blocks

Sigortalı ve Bıçaklı Ayırma Klemensleri Fuse and Disconnect Terminal Blocks

Ürün Adı / Product Name
Sipariş No / Order No.
Paket Adeti / Packing Qty.
Anma Değerleri / Rated Values
IEC 60947-7-3 (FDT 4) / IEC 60947-7-1 (TBL S)
Bağlantı Bilgileri / Connection Information
Kesit / Cross-Section (mm²)
Tek Damarlı Kablo / Solid Conductor Cross-Section min mm²: (mm²)-(min-max)
Çok Damarlı Kablo / Stranded Conductor Cross-Section (mm²)-(min-max)
Çok Tellî Kablo / Flexible Conductor Cross-Section (mm²)-(min-max)
AWG
Açıklamalar / Descriptions
Kablo Soyma Uzunluğu / Insulation Stripping Length (mm)
Max. Sıkma Torku (N.m) / Max. Tightening Torque
Bağlantı Vidası / Screw Diameter
Darbe Gerilimi / Rated Impulse Voltage (Kv)
Kirlilik Derecesi / Gerilim Kategorisi / Malzeme Grubu / Pollution Degree / Voltage Category / Material Group
Aksesuarlar / Accessories
Montaj Rayı / Din Rail
Durdurucu / End Stopper
Tarak Köprü / Comb Connector
Klemens Etiketleri / Marking Tags
Şerit Etiket / Strip Label
Grup Etiketleri / Group Label
Tornavida / Screwdriver

* **TM1 Sadece PS2 ürünü ile Uyumludur.**

* TM1 is only suitable for PS2

** **Sigortalı ve bıçaklı ayırma klemenslerimiz iki tarafı kapalı tipte olduğundan, nihayet plakası seçimine gerek yoktur.**

** Fuse and disconnect type terminal blocks are double side closed, no need for an extra end plate usage.

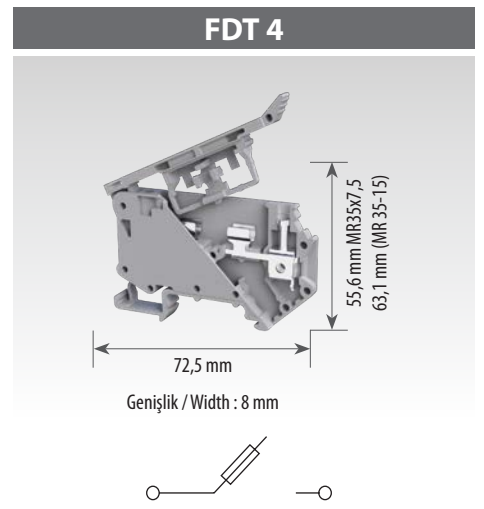

FDT 4		
8003099488		
25		
800 V / 6,3 A		
4		
0,5 - 4		
0,5 - 4		
0,5 - 4		
20-12 AWG		
12		
0,5		
M3		
8		
3 / III / I		
Ürün Adı / Product Name	Sipariş No / Order No.	Adet / Qty.
DR 35-7,5 S 2M	8015393407	40
DR 35-15 S 2M	8015393427	20
SS 1	8010097308	50
SS 2	8010097318	50
PS 1	8010197328	50
PS 2	8010197420	50
TCC 6/2	8013394823	50
TCC 6/3	8013394833	50
TCC 6/10	8013394803	50
MTG 8	8020386009	500
TBSL 22X20	8020384009	1
GM1	8014393008	50
GM2	8014393018	50
TM1	8014393020	50
0,5x3,0		

FDT 4 L

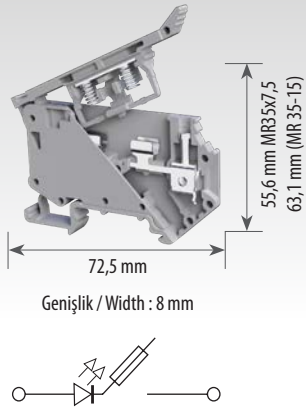

FDT 4 L (110-220 VAC/DC)

8003099508

25

800 V / 6,3 A

4

0,5 - 4

0,5 - 4

0,5 - 4

20-12 AWG

12

0,5

M3

8

3 / III / I

Ürün Adı Product Name	Sipariş No Order No.	Adet Qty.
DR 35-7,5 S 2M	8015393407	40
DR 35-15 S 2M	8015393427	20
SS 1	8010097308	50
SS 2	8010097318	50
PS 1	8010197328	50
PS 2	8010197420	50
TCC 6/2	8013394823	50
TCC 6/3	8013394833	50
TCC 6/10	8013394803	50
MTG 8	8020386009	500
TBSL 22X20	8020384009	1
GM1	8014393008	50
GM2	8014393018	50
TM1	8014393020	50
0,5x3,0		

* **TM1 Sadece PS2 ürünü ile Uyumludur.**

* TM1 is only suitable for PS2

** **Sigortalı ve bıçaklı ayırma klemenslerimiz iki tarafı kapalı tipte olduğundan, nihayet plakası seçimine gerek yoktur.**

** Fuse and disconnect type terminal blocks are double side closed, no need for an extra end plate usage.

Mini Cam Sigorta Mini Glass Fuse

Ürün Adı Product Name	Sipariş No Order No.	Adet Qty.
MGF 0,05A	8014401200	10
MGF 0,25A	8014401210	10
MGF 0,5A	8014401220	10
MGF 1A	8014401230	10
MGF 2A	8014401240	10
MGF 2,5A	8014401250	10
MGF 3,15A	8014401260	10
MGF 4A	8014401270	10
MGF 5A	8014401280	10
MGF 6,3A	8014401290	10

Sigorta Tipi Bakır Bara Fuse Shaped Copper Bar

Ürün Adı Product Name	Sipariş No Order No.	Adet Qty.
FSCB 5x20	8014401100	10

FDT 4 L Series

Ürün Adı Product Name	Renk Color	Sipariş No Order No.	Adet Qty.
FDT 4 L (24-48 VAC/DC)	●	8003099498	25
FDT 4 L (110-220 VAC/DC)	●	8003099508	25
FDT 4 L (24-48 VAC/DC)	●	8003099496	25
FDT 4 L (110-220 VAC/DC)	●	8003099506	25
FDT 4	●	8003099486	25



Vida Bağlantılı Ray Klemensleri Screw Type Terminal Blocks

Sigortalı ve Bıçaklı Ayırma Klemensleri Fuse and Disconnect Terminal Blocks



Ürün Adı / Product Name	
Sipariş No / Order No.	
Paket Adeti / Packing Qty.	
Anma Değerleri / Rated Values	IEC 60947-7-3 (FDT 4) / IEC 60947-7-1 (TBL S)
Bağlantı Bilgileri / Connection Information	
Kesit / Cross-Section (mm²)	
Tek Damarlı Kablo / Solid Conductor Cross-Section min mm²: (mm²)-(min-max)	
Çok Damarlı Kablo / Stranded Conductor Cross-Section (mm²)-(min-max)	
Çok Tellî Kablo / Flexible Conductor Cross-Section (mm²)-(min-max)	
AWG	
Açıklamalar / Descriptions	
Kablo Soyma Uzunluğu / Insulation Stripping Length (mm)	
Sıkma Torku (N.m) / Tightening Torque	
Bağlantı Vidası / Screw Diameter	
Darbe Gerilimi / Rated Impulse Voltage (Kv)	
Kirlilik Derecesi / Gerilim Kategorisi / Malzeme Grubu / Pollution Degree / Voltage Category / Material Group	
Aksesuarlar / Accessories	
Montaj Rayı / Din Rail	
Durdurucu / End Stopper	
Nihayet Plakası / End Plate	
Tarak Köprü / Comb Connector	
Üst Köprü / Cross Connection	
Klemens Etiketleri / Marking Tags	
Şerit Etiket / Strip Label	
Grup Etiketleri / Group Label	
Tornavida / Screwdriver	

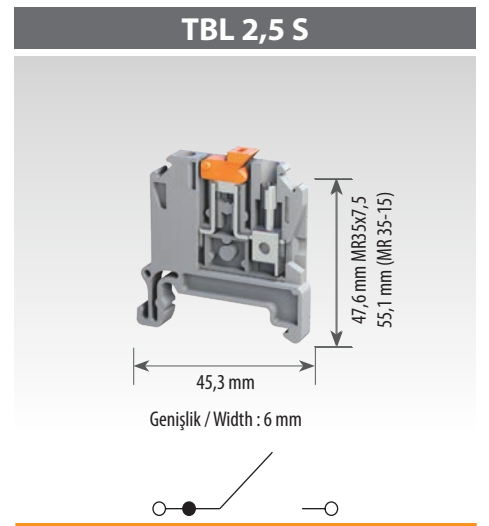

TBL 2,5 S		
8003099528		
50		
500 V / 17,5 A		
2,5		
0,5 - 4		
0,5 - 4		
0,5 - 4		
20-12 AWG		
12		
0,6		
M2,5		
6		
3 / III / I		
Ürün Adı / Product Name	Sipariş No / Order No.	Adet / Qty.
DR 35-7,5 S 2M	8015393407	40
DR 35-15 S 2M	8015393427	20
SS 1	8010097308	50
SS 2	8010097318	50
PS 1	8010197328	50
PS 2	8010197420	50
TCC 2,5/2	8013094223	50
TCC 2,5/3	8013094203	50
TCC 2,5/10	8013094233	10
MTG 6	8020388009	500
GM1	8014393008	50
GM2	8014393018	50
TM1	8014393020	50
0,5x3,0		

* TM1 Sadece PS2 ürünü ile Uyumludur.

* TM1 is only suitable for PS2

NTB 4 P+F

YENİ
NEW

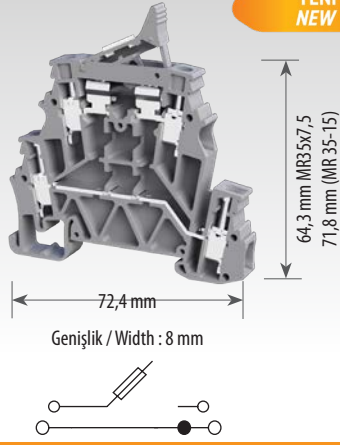

NTB 4 P+F

8003098008

25

500 V / 32 A

4

0,5 - 6

0,5 - 6

0,5 - 4

20-10 AWG

10

0,6

M2,6

6

3 / III / I

Ürün Adı Product Name	Sipariş No Order No.	Adet Qty.
DR 35-7,5 S 2M	8015393407	40
DR 35-15 S 2M	8015393427	20
SS 1	8010097308	50
SS 2	8010097318	50
PS 1	8010197328	50
PS 2	8010197420	50
EPL NTB 4 F+P	8012396588	50
TCC 6/2	8013394823	50
TCC 6/3	8013394833	50
TCC 6/10	8013394803	50
PCC 6/2	8013294723	50
PCC 6/3	8013294733	50
PCC 6/10	8013294703	10
MTG 8	8020386009	500
TBSL 22x20	8020384009	1
GM1	8014393008	50
GM2	8014393018	50
TM1	8014393020	50
0,5x3.0		

Mini Cam Sigorta Mini Glass Fuse

Ürün Adı Product Name	Sipariş No Order No.	Adet Qty.
MGF 0,05A	8014401200	10
MGF 0,25A	8014401210	10
MGF 0,5A	8014401220	10
MGF 1A	8014401230	10
MGF 2A	8014401240	10
MGF 2,5A	8014401250	10
MGF 3,15A	8014401260	10
MGF 4A	8014401270	10
MGF 5A	8014401280	10
MGF 6,3A	8014401290	10

Sigorta Tipi Bakır Bara Fuse Shaped Copper Bar

Ürün Adı Product Name	Sipariş No Order No.	Adet Qty.
FSCB 5x20	8014401100	10

NTB 4 P Series

Ürün Adı Product Name	Renk Color	Sipariş No Order No.	Adet Qty.
NTB 4 P+F Gri (24-48 VAC/DC)	●	8003098018	25
NTB 4 P+F Gri (110-220 VAC/DC)	●	8003098028	25
NTB 4 P+F Gri (110-220VAC)	●	8003098038	25

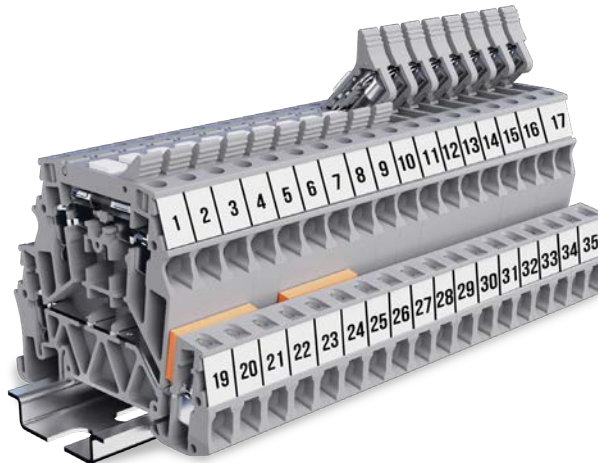

Vida Bağlantılı Ray Klemensleri Screw Type Terminal Blocks

Ölçme Ayırma Klemensleri Test and Disconnect Terminal Blocks



Ürün Adı / Product Name
Sipariş No / Order No.
Paket Adeti / Packing Qty.
Anma Değerleri / Rated Values
IEC 60947-7-1
Bağlantı Bilgileri / Connection Information
Kesit / Cross-Section (mm ²)
Tek Damarlı Kablo / Solid Conductor Cross-Section min mm ² : (mm ²)-(min-max)
Çok Damarlı Kablo / Stranded Conductor Cross-Section (mm ²)-(min-max)
Çok Telli Kablo / Flexible Conductor Cross-Section (mm ²)-(min-max)
AWG
Açıklamalar / Descriptions
Kablo Soyma Uzunluğu / Insulation Stripping Length (mm)
Max. Sıkma Torku (N.m) / Max. Tightening Torque
Bağlantı Vidası / Screw Diameter
Darbe Gerilimi / Rated Impulse Voltage (Kv)
Kirlilik Derecesi / Gerilim Kategorisi / Malzeme Grubu / Pollution Degree / Voltage Category / Material Group
Merkez Vida / Sıkma Torku (N.m) / Center Screw / Tightening Torque
Aksesuarlar / Accessories
Montaj Rayı / Din Rail
Durdurucu / End Stopper
Nihayet Plakası / End Plate Section
Kayar Köprü / Swipe Connector
Tarak Köprü / Comb Connector
Test Fişi / Test Plug
Klemens Etiketi / Marking Tags
Grup Etiketi / Group Label
Tornavida / Screwdriver

* TM1 Sadece PS2 ürünü ile Uyumludur.

* TM1 is only suitable for PS2

TDT-C 6

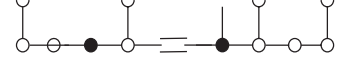
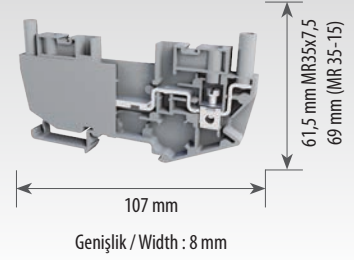

TDT-C 6		
8004099808		
20		
400 V / 41 A		
6		
0,5 - 10		
0,5 - 10		
0,5 - 6		
20-8 AWG		
12		
1,2		
M3,5		
6		
3 / III / I		
M3 / 0,5		
Ürün Adı Product Name	Sipariş No Order No.	Adet Qty.
DR 35-7,5 S 2M	8015393407	40
DR 35-15 S 2M	8015393427	20
SS 1	8010097308	50
SS 2	8010097318	50
PS 1	8010197328	50
PS 2	8010197420	50
SLC 2	8013394923	50
SLC 3	8013394933	50
SLC 4	8013394943	50
TCC 6/2	8013394823	50
TCC 6/3	8013394833	50
TCC 6/10	8013394803	10
TST-I 1	8014393108	50
MTG 8	8020386009	500
GM1	8014393008	50
GM2	8014393018	50
TM1	8014393020	50
0,5x3.0 / 0,6x3,5		

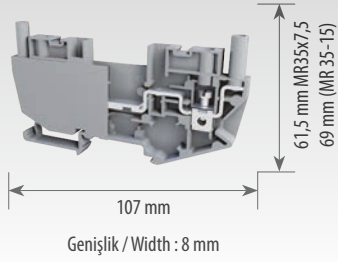
TDT-V 6**TDT-V 6**

8004099818

20

400 V / 41 A

6

0,5 - 10

0,5 - 10

0,5 - 6

20-8 AWG

12

1,2

M3,5

6

3 / III / I

M3 / 0,5

Ürün Adı Product Name	Sipariş No Order No.	Adet Qty.
DR 35-7,5 S 2M	8015393407	40
DR 35-15 S 2M	8015393427	20
SS 1	8010097308	50
SS 2	8010097318	50
PS 1	8010197328	50
PS 2	8010197420	50
SLC 2	8013394923	50
SLC 3	8013394933	50
SLC 4	8013394943	50
TCC 6/2	8013394823	50
TCC 6/3	8013394833	50
TCC 6/10	8013394803	10
TST-I 1	8014393108	50
MTG 8	8020386009	500
GM1	8014393008	50
GM2	8014393018	50
TM1	8014393020	50
0,6x3,5		

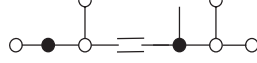
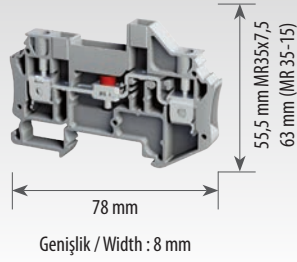
TDS-C 6**TDS-C 6**

8004099828

25

400 V / 41 A

6

0,5 - 10

0,5 - 10

0,5 - 6

20-8 AWG

12

1,2

M3,5

6

3 / III / I

M3 / 0,5

Ürün Adı Product Name	Sipariş No Order No.	Adet Qty.
DR 35-7,5 S 2M	8015393407	40
DR 35-15 S 2M	8015393427	20
SS 1	8010097308	50
SS 2	8010097318	50
PS 1	8010197328	50
PS 2	8010197420	50
EPL TDS	8012396018	50
SLC 2	8013394923	50
SLC 3	8013394933	50
SLC 4	8013394943	50
TCC 6/2	8013394823	50
TCC 6/3	8013394833	50
TCC 6/10	8013394803	10
TST-I 1	8014393108	50
MTG 8	8020386009	500
GM1	8014393008	50
GM2	8014393018	50
TM1	8014393020	50
0,5x3,0 / 0,6x3,5		

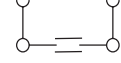
TDV-C 6**TDV-C 6**

8004099838

25

500 V / 41 A

6

0,5 - 10

0,5 - 10

0,5 - 6

20-8 AWG

12

1,2

M3,5

6

3 / III / I

M3 / 0,5

Ürün Adı Product Name	Sipariş No Order No.	Adet Qty.
DR 35-7,5 S 2M	8015393407	40
DR 35-15 S 2M	8015393427	20
SS 1	8010097308	50
SS 2	8010097318	50
PS 1	8010197328	50
PS 2	8010197420	50
EPL TDV	8012396028	50
TCC 6/2	8013394823	50
TCC 6/3	8013394833	50
TCC 6/10	8013394803	10
TST-I 1	8014393108	50
MTG 5	8020389009	500
GM1	8014393008	50
GM2	8014393018	50
TM1	8014393020	50
1,0x5,5		

* TM1 Sadece PS2 ürünü ile Uyumludur.

* TM1 is only suitable for PS2

Vida Bağlantılı Ray Klemensleri Screw Type Terminal Blocks

Ölçme Ayırma Klemensleri Test and Disconnect Terminal Blocks



Ürün Adı / Product Name

Sipariş No / Order No.

Paket Adeti / Packing Qty.

Anma Değerleri / Rated Values

IEC 60947-7-1

Bağlantı Bilgileri / Connection Information

Kesit / Cross-Section (mm²)

Tek Damarlı Kablo / Solid Conductor Cross-Section min mm²: (mm²)-(min-max)

Çok Damarlı Kablo / Stranded Conductor Cross-Section (mm²)-(min-max)

Çok Telli Kablo / Flexible Conductor Cross-Section (mm²)-(min-max)

AWG

Açıklamalar / Descriptions

Kablo Soyma Uzunluğu / Insulation Stripping Length (mm)

Max. Sıkma Torku (N.m) / Max. Tightening Torque

Bağlantı Vidası / Screw Diameter

Darbe Gerilimi / Rated Impulse Voltage (Kv)

Kirlilik Derecesi / Gerilim Kategorisi / Malzeme Grubu / Pollution Degree / Voltage Category / Material Group

Merkez Vida / Sıkma Torku (N.m) / Center Screw / Tightening Torque

Aksesuarlar / Accessories

Montaj Rayı / Din Rail

Durdurucu / End Stopper

Nihayet Plakası / End Plate Section

Üst Köprü / Cross Connection

TDV Serisi Üst Köprü Tutucu / TDV Jumper Holder

Kayar Köprü / Swipe Connector

Tarak Köprü / Comb Connector

Test Fişi / Test Plug

Klemens Etiketi / Marking Tags

Şerit Etiket / Strip Label

Grup Etiketi / Group Label

Tornavida / Screwdriver

* TM1 Sadece PS2 ürünü ile Uyumludur.

* TM1 is only suitable for PS2

TDS-V 6

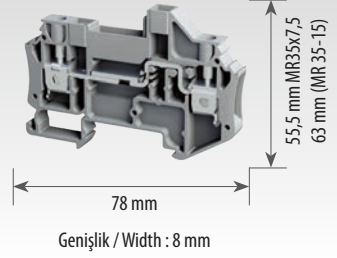

Genişlik / Width : 8 mm



TDS-V 6

8004099848

25

400 V

6

0,5 - 10

0,5 - 10

0,5 - 6

20-8 AWG

12

1,2

M3,5

6

3 / III / I

Ürün Adı Product Name	Sipariş No Order No.	Adet Qty.
DR 35-7,5 S 2M	8015393407	40
DR 35-15 S 2M	8015393427	20
PS 2	8010197420	50
EPL TDS	8012396018	50
SLC 2	8013394923	50
SLC 3	8013394933	50
SLC 4	8013394943	50
TCC 6/2	8013394823	50
TCC 6/3	8013394833	50
TCC 6/10	8013394803	10
TST-I 1	8014393108	50
MTG 8	8020386009	500
TBSL 22X20	8020384009	1
GM1	8014393008	50
GM2	8014393018	50
TM1	8014393020	50
0,6x3,5		

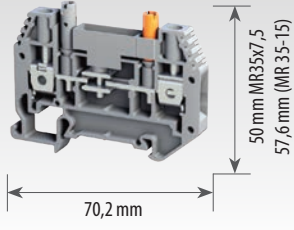
TDY-C 6

Genişlik / Width : 8 mm

**TDY-C 6**

8004099858

25

400 V

6

0,5 - 10

0,5 - 10

0,5 - 6

20-8 AWG

12

1,2

M3,5

6

3 / III / I

M3 / 0,5

Ürün Adı Product Name	Sipariş No Order No.	Adet Qty.
DR 35-7,5 S 2M	8015393407	40
DR 35-15 S 2M	8015393427	20
PS 2	8010197420	50
EPL TDY	8012396038	50
SLC-R 2	8014393307	50
SLC-R 3	8014393317	50
SLC-R 4	8014393327	50
TCC 6/2	8013394823	50
TCC 6/3	8013394833	50
TCC 6/10	8013394803	10
TST-I 1	8014393108	50
MTG 8	8020386009	500
GM1	8014393008	50
GM2	8014393018	50
TM1	8014393020	50
0,6x3,5 / 0,5x3,0		

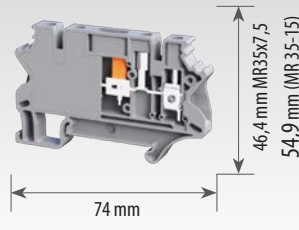
TDV-6YENİ
NEW

Genişlik / Width : 8 mm

**TDV-6**

8004099878

25

1000 V / 41 A

6

0,5 - 10

0,5 - 10

0,5 - 10

20-8 AWG

12

1,2

M3,5

6

3 / III / I

M3 / 0,5

Ürün Adı Product Name	Sipariş No Order No.	Adet Qty.
DR 35-7,5 S 2M	8015393407	40
DR 35-15 S 2M	8015393427	20
PS 2	8010197420	50
PCC 6/2-T	8013295723	50
PCC 6/3-T	8013295733	50
PCC 6/10-T	8013295703	10
JH-TDV	8014001003	1
TCC 6/2	8013394823	50
TCC 6/3	8013394833	50
TCC 6/10	8013394803	10
TFT 4	8014394250	50
MTG 8	8020386009	500
TBSL 22x20	8020384009	1
GM1	8014393008	50
GM2	8014393018	50
TM1	8014393020	50
0,6x3,5		

* TM1 Sadece PS2 ürünü ile Uyumludur.

* TM1 is only suitable for PS2

Push-in Klemensleri Push-in Terminal Blocks

Geçiş Klemensleri Feed Through Terminal Blocks



Ürün Adı / Product Name	
Sipariş No / Order No.	
Paket Adeti / Packing Qty.	
Anma Değerleri / Rated Values	IEC 60947-7-1
Bağlantı Bilgileri / Connection Information	
Kesit / Cross-Section (mm²)	
Tek Damarlı Kablo / Solid Conductor Cross-Section min mm²: (mm²)-(min-max)	
Çok Damarlı Kablo / Stranded Conductor Cross-Section (mm²)-(min-max)	
Çok Tellli Kablo / Flexible Conductor Cross-Section (mm²)-(min-max)	
AWG	
Açıklamalar / Descriptions	
Kablo Soyma Uzunluğu / Insulation Stripping Length (mm)	
Max. Sıkma Torku (N.m) / Max. Tightening Torque	
Bağlantı Vidası / Screw Diameter	
Darbe Gerilimi / Rated Impulse Voltage (Kv)	
Kirlilik Derecesi / Gerilim Kategorisi / Malzeme Grubu / Pollution Degree / Voltage Category / Material Group	
Aksesuarlar / Accessories	
Montaj Rayı / Din Rail	
Durdurucu / End Stopper	
Üst Köprü / Cross Connection	
Klemens Etiketleri / Marking Tags	
Şerit Etiket / Strip Label	
Grup Etiketleri / Group Label	

PFT 2,5

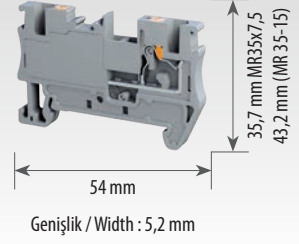

PFT 2,5		
8000298008		
100		
800 V / 24 A		
2,5		
0,5 - 2,5		
0,5 - 2,5		
0,5 - 2,5		
20-12 AWG		
12		
8		
3 / III / I		
Ürün Adı / Product Name	Sipariş No / Order No.	Adet / Qty.
DR 35-7,5 S 2M	8015393407	40
DR 35-15 S 2M	8015393427	20
PS 1	8010197328	50
PS 2	8010197420	50
PCC 2,5/2	8013294523	100
PCC 2,5/3	8013294533	100
PCC 2,5/10	8013294503	10
MTG 5	8020389009	500
TBSL 22X20	8020384009	1
GM1	8014393008	50
GM2	8014393018	50
TM1	8014393020	50

* TM1 Sadece PS2 ürünü ile Uyumludur.

* TM1 is only suitable for PS2

** PFT Serisi klemenslerimiz iki tarafı kapalı tipte olduğundan, nihayet plakası seçimine gerek yoktur.

** PFT Series terminal blocks are double side closed, no need for an extra end plate usage.

Renk Kodları / Color Codes								
800009900....	...0	...1	...2	...3	...4	...5	...6	...9

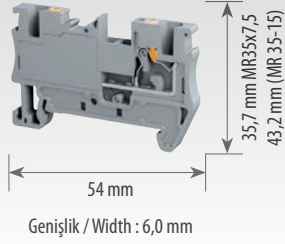
PFT 4**PFT 4**

8000298018

100

800 V / 32 A

4

1,5 - 4

1,5 - 4

1,5 - 4

20-10 AWG

12

8

3 / III / I

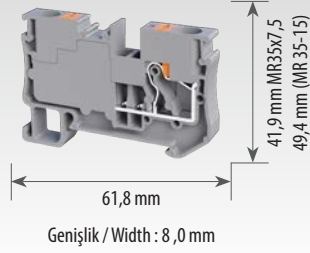
PFT 6**PFT 6**

8000298028

50

1000 V / 41 A

6

1,5 - 6

1,5 - 6

1,5 - 6

20-8 AWG

12

8

3 / III / I

Ürün Adı Product Name	Sipariş No Order No.	Adet Qty.
DR 35-7,5 S 2M	8015393407	40
DR 35-15 S 2M	8015393427	20
PS 1	8010197328	50
PS 2	8010197420	50
PCC 4/2	8013294623	100
PCC 4/3	8013294633	100
PCC 4/10	8013294603	10
MTG 6	8020388009	500
TBSL 22X20	8020384009	1
GM1	8014393008	50
GM2	8014393018	50
TM1	8014393020	50

Ürün Adı Product Name	Sipariş No Order No.	Adet Qty.
DR 35-7,5 S 2M	8015393407	40
DR 35-15 S 2M	8015393427	20
PS 1	8010197328	50
PS 2	8010197420	50
PCC 6/2	8013294723	50
PCC 6/3	8013294733	50
PCC 6/10	8013294703	10
MTG 8	8020386009	500
TBSL 22X20	8020384009	1
GM1	8014393008	50
GM2	8014393018	50
TM1	8014393020	50

* **TM1 Sadece PS2 ürünü ile Uyumludur.**

* TM1 is only suitable for PS2

* **PFT Serisi klemenslerimiz iki tarafı kapalı tipte olduğundan, nihayet plakası seçimine gerek yoktur.**

* PFT Series terminal blocks are double side closed, no need for an extra end plate usage.

Push-in Klemensleri Push-in Terminal Blocks

Geçiş Klemensleri Feed Through Terminal Blocks



Ürün Adı / Product Name
Sipariş No / Order No.
Paket Adeti / Packing Qty.
Anma Değerleri / Rated Values
IEC 60947-7-1
Bağlantı Bilgileri / Connection Information
Kesit / Cross-Section (mm²)
Tek Damarlı Kablo / Solid Conductor Cross-Section min mm²: (mm²)-(min-max)
Çok Damarlı Kablo / Stranded Conductor Cross-Section (mm²)-(min-max)
Çok Tellli Kablo / Flexible Conductor Cross-Section (mm²)-(min-max)
AWG
Açıklamalar / Descriptions
Kablo Soyma Uzunluğu / Insulation Stripping Length (mm)
Sıkma Torku (N.m) / Tightening Torque
Bağlantı Vidası / Screw Diameter
Darbe Gerilimi / Rated Impulse Voltage (Kv)
Kirlilik Derecesi / Gerilim Kategorisi / Malzeme Grubu / Pollution Degree / Voltage Category / Material Group
Aksesuarlar / Accessories
Montaj Rayı / Din Rail
Durdurucu / End Stopper
Üst Köprü / Cross Connection
Klemens Etiketli / Marking Tags
Şerit Etiket / Strip Label
Grup Etiketli / Group Label

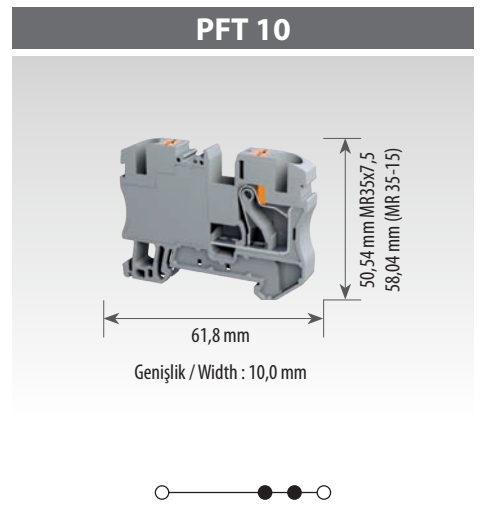

PFT 10
8000298038
30
800 V / 57 A
10
0,5 - 16
0,5 - 10
0,5 - 10
20-6 AWG
18
8
3 / III / I

Ürün Adı Product Name	Sipariş No Order No.	Adet Qty.
DR 35-7,5 S 2M	8015393407	40
DR 35-15 S 2M	8015393427	20
PS 1	8010197328	50
PS 2	8010197420	50
PCC 10/2	8013294823	10
PCC 10/3	8013294833	10
MTG 10	8020385009	250
TBSL 22X20	8020384009	1
GM1	8014393008	50
GM2	8014393018	50
TM1	8014393020	50

* **TM1 Sadece PS2 ürünü ile Uyumludur.**

* TM1 is only suitable for PS2

** **PFT Serisi klemenslerimiz iki tarafı kapalı tipte olduğundan, nihayet plakası seçimine gerek yoktur.**

** PFT Series terminal blocks are double side closed, no need for an extra end plate usage.

Renk Kodları / Color Codes								
800009900....	...0	...1	...2	...3	...4	...5	...6	...9

PFT 16

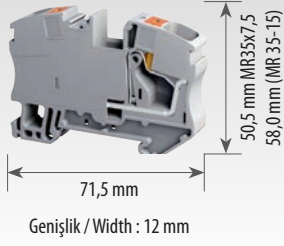

PFT 16

8000298048

25

1000 V / 76 A

16

0,5 - 25

0,5 - 16

0,5 - 16

20-4 AWG

18

8

3 / III / I

Ürün Adı Product Name	Sipariş No Order No.	Adet Qty.
DR 35-7,5 S 2M	8015393407	40
DR 35-15 S 2M	8015393427	20
PS 1	8010197328	50
PS 2	8010197420	50
PCC 16/2	8013294923	10
MTG 10	8020385009	250
TBSL 22X20	8020384009	1
GM1	8014393008	50
GM2	8014393018	50
TM1	8014393020	50

Renk Kodları / Color Codes		
800029806....	...0	...6

***TM1 Sadece PS2 ürünü ile Uyumludur.**

*TM1 is only suitable for PS2

**** PFT Serisi klemenslerimiz iki tarafı kapalı tipte olduğundan, nihayet plakası seçimine gerek yoktur.**

** PFT Series terminal blocks are double side closed, no need for an extra end plate usage.

Push-in Klemensleri Push-in Terminal Blocks

Topraklama Klemensleri Earth Terminal Blocks



Ürün Adı / Product Name

Sipariş No / Order No.

Paket Adeti / Packing Qty.

Anma Değerleri / Rated Values

IEC 60947-7-2

Bağlantı Bilgileri / Connection Information

Kesit / Cross-Section (mm²)

Tek Damarlı Kablo / Solid Conductor Cross-Section min mm²: (mm²)-(min-max)

Çok Damarlı Kablo / Stranded Conductor Cross-Section (mm²)-(min-max)

Çok Telli Kablo / Flexible Conductor Cross-Section (mm²)-(min-max)

AWG

Açıklamalar / Descriptions

Kablo Soyma Uzunluğu / Insulation Stripping Length (mm)

Max. Sıkma Torku (N.m) / Max. Tightening Torque

Bağlantı Vidası / Screw Diameter

Darbe Gerilimi / Rated Impulse Voltage (Kv)

Kirlilik Derecesi / Gerilim Kategorisi / Malzeme Grubu / Pollution Degree / Voltage Category / Material Group

Aksesuarlar / Accessories

Montaj Rayı / Din Rail

Durdurucu / End Stopper

Klemens Etiketi / Marking Tags

Şerit Etiket / Strip Label

Grup Etiketi / Group Label

PFT 2,5 E

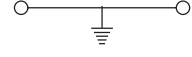
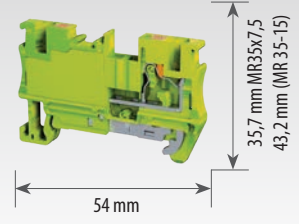

PFT 2,5 E

8001298064

50

2,5

0,5 - 2,5

0,5 - 2,5

0,5 - 2,5

20-12 AWG

12

8

3 / III / I

Ürün Adı Product Name	Sipariş No Order No.	Adet Qty.
DR 35-7,5 S 2M	8015393407	40
DR 35-15 S 2M	8015393427	20
PS 1	8010197328	50
PS 2	8010197420	50
MTG 5	8020389009	500
TBSL 22X20	8020384009	1
GM1	8014393008	50
GM2	8014393018	50
TM1	8014393020	50

* **TM1 Sadece PS2 ürünü ile uyumludur.**

* TM1 is only suitable for PS2

** **PFT Serisi klemenslerimiz iki tarafı kapalı tipte olduğundan, nihayet plakası seçimine gerek yoktur.**

** PFT Series terminal blocks are double side closed, no need for an extra end plate usage.

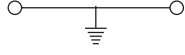
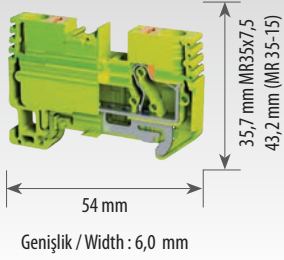
PFT 4 E**PFT 4 E**

8001298074

50

4

1,5 - 4

1,5 - 4

1,5 - 4

20-10 AWG

12

8

3 / III / I

Ürün Adı Product Name	Sipariş No Order No.	Adet Qty.
DR 35-7,5 S 2M	8015393407	40
DR 35-15 S 2M	8015393427	20
PS 1	8010197328	50
PS 2	8010197420	50
MTG 6	8020389009	500
TBSL 22X20	8020384009	1
GM1	8014393008	50
GM2	8014393018	50
TM1	8014393020	50

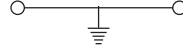
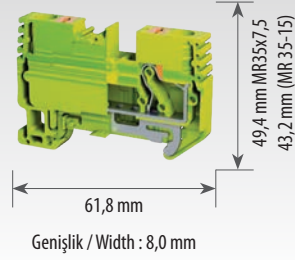
PFT 6 E**PFT 6 E**

8001298084

25

6

1,5 - 6

1,5 - 6

1,5 - 6

20-8 AWG

12

8

3 / III / I

Ürün Adı Product Name	Sipariş No Order No.	Adet Qty.
DR 35-7,5 S 2M	8015393407	40
DR 35-15 S 2M	8015393427	20
PS 1	8010197328	50
PS 2	8010197420	50
MTG 8	8020389009	500
TBSL 22X20	8020384009	1
GM1	8014393008	50
GM2	8014393018	50
TM1	8014393020	50

* **TM1 Sadece PS2 ürünü ile Uyumludur.**

* TM1 is only suitable for PS2

** **PFT Serisi klemenslerimiz iki tarafı kapalı tipte olduğundan, nihayet plakası seçimine gerek yoktur.**

** PFT Series terminal blocks are double side closed, no need for an extra end plate usage.

Push-in Klemensleri Push-in Terminal Blocks

Topraklama Klemensleri Earth Terminal Blocks



Ürün Adı / Product Name

Sipariş No / Order No.

Paket Adeti / Packing Qty.

Anma Değerleri / Rated Values

IEC 60947-7-2

Bağlantı Bilgileri / Connection Information

Kesit / Cross-Section (mm²)

Tek Damarlı Kablo / Solid Conductor Cross-Section min mm²: (mm²)-(min-max)

Çok Damarlı Kablo / Stranded Conductor Cross-Section (mm²)-(min-max)

Çok Tellî Kablo / Flexible Conductor Cross-Section (mm²)-(min-max)

AWG

Açıklamalar / Descriptions

Kablo Soyma Uzunluğu / Insulation Stripping Length (mm)

Max. Sıkma Torku (N.m) / Max. Tightening Torque

Bağlantı Vidası / Screw Diameter

Darbe Gerilimi / Rated Impulse Voltage (Kv)

Kirlilik Derecesi / Gerilim Kategorisi / Malzeme Grubu / Pollution Degree / Voltage Category / Material Group

Aksesuarlar / Accessories

Montaj Rayı / Din Rail

Durdurucu / End Stopper

Klemens Etiketleri / Marking Tags

Şerit Etiket / Strip Label

Grup Etiketleri / Group Label

PFT 10 E

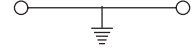
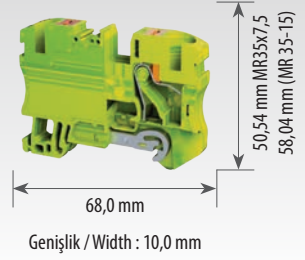

PFT 10 E

8001298104

30

10

1,5 - 16

1,5 - 10

1,5 - 10

20-6 AWG

18

8

3 / III / I

Ürün Adı Product Name	Sipariş No Order No.	Adet Qty.
DR 35-7,5 S 2M	8015393407	40
DR 35-15 S 2M	8015393427	20
PS 1	8010197328	50
PS 2	8010197420	50
MTG 10	8020385009	250
TBSL 22X20	8020384009	1
GM1	8014393008	50
GM2	8014393018	50
TM1	8014393020	50

* **TM1 Sadece PS2 ürünü ile uyumludur.**

* TM1 is only suitable for PS2

** **PFT Serisi klemenslerimiz iki tarafı kapalı tipte olduğundan, nihayet plakası seçimine gerek yoktur.**

** PFT Series terminal blocks are double side closed, no need for an extra end plate usage.

PFT 16 E

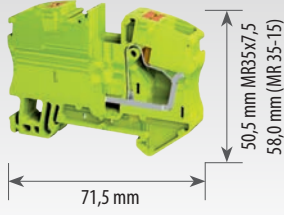

Genişlik / Width : 12 mm

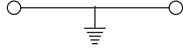

PFT 16 E

8001298114

25

16

1,5 - 25

1,5 - 16

1,5 - 16

20-4 AWG

18

8

3 / III / I

Ürün Adı Product Name	Sipariş No Order No.	Adet Qty.
DR 35-7,5 S 2M	8015393407	40
DR 35-15 S 2M	8015393427	20
PS 1	8010197328	50
PS 2	8010197420	50
MTG 10	8020385009	250
TBSL 22X20	8020384009	1
GM1	8014393008	50
GM2	8014393018	50
TM1	8014393020	50

* **TM1 Sadece PS2 ürünü ile Uyumludur.**

* TM1 is only suitable for PS2

** **PFT Serisi klemenslerimiz iki tarafı kapalı tipte olduğundan, nihayet plakası seçimine gerek yoktur.**

** PFT Series terminal blocks are double side closed, no need for an extra end plate usage.

Push-in Klemensleri Push-in Terminal Blocks

Çok Girişli ve Çıkışlı Klemensler
Multi - Entry and Multi - Level Terminal Blocks



Ürün Adı / Product Name
Sipariş No / Order No.
Paket Adeti / Packing Qty.
Anma Değerleri / Rated Values
IEC 60947-7-1
Bağlantı Bilgileri / Connection Information
Kesit / Cross-Section (mm²)
Tek Damarlı Kablo / Solid Conductor Cross-Section min mm²: (mm²)-(min-max)
Çok Damarlı Kablo / Stranded Conductor Cross-Section (mm²)-(min-max)
Çok Tellî Kablo / Flexible Conductor Cross-Section (mm²)-(min-max)
AWG
Açıklamalar / Descriptions
Kablo Soyma Uzunluğu / Insulation Stripping Length (mm)
Max. Sıkma Torku (N.m) / Max. Tightening Torque
Bağlantı Vidası / Screw Diameter
Darbe Gerilimi / Rated Impulse Voltage (Kv)
Kirlilik Derecesi / Gerilim Kategorisi / Malzeme Grubu / Pollution Degree / Voltage Category / Material Group
Aksesuarlar / Accessories
Montaj Rayı / Din Rail
Durdurucu / End Stopper
Üst Köprü / Cross Connection
Klemens Etiketi / Marking Tags
Şerit Etiket / Strip Label
Grup Etiketi / Group Label

PFT 2,5 1X2

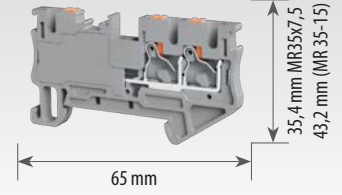

Genişlik / Width : 5,2 mm



PFT 2,5 1X2		
8000298068		
40		
800 V / 24 A		
2,5		
0,5 - 2,5		
0,5 - 2,5		
0,5 - 2,5		
20-12 AWG		
12		
8		
3 / III / I		
Ürün Adı / Product Name	Sipariş No / Order No.	Adet / Qty.
DR 35-7,5 S 2M	8015393407	40
DR 35-15 S 2M	8015393427	20
PS 1	8010197328	50
PS 2	8010197420	50
PCC 2,5/2	8013294523	100
PCC 2,5/3	8013294533	100
PCC 2,5/10	8013294503	10
MTG 5	8020389009	500
TBSL 22X20	8020384009	1
GM1	8014393008	50
GM2	8014393018	50
TM1	8014393020	50
Renk Kodları / Color Codes		
800029806....	...0	...6

* **TM1 Sadece PS2 ürünü ile Uyumludur.**

* TM1 is only suitable for PS2

** **PFT Serisi klemenslerimiz iki tarafı kapalı tipte olduğundan, nihayet plakası seçimine gerek yoktur.**

** PFT Series terminal blocks are double side closed, no need for an extra end plate usage.

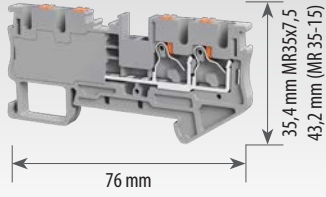
PFT 2,5 2X2

Genişlik / Width : 5,2 mm

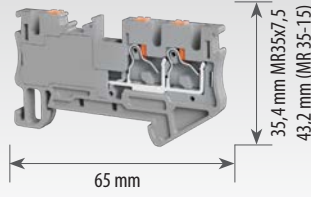
**PFT 4 1X2****YENİ
NEW**

Genişlik / Width : 6 mm

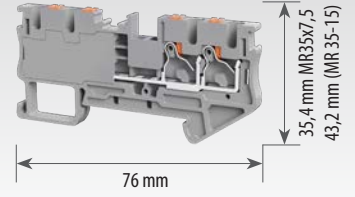
**PFT 4 2X2****YENİ
NEW**

Genişlik / Width : 6 mm

**PFT 2,5 2X2**

8000298078

40

800 V / 24 A

2,5

0,5 - 2,5

0,5 - 2,5

0,5 - 2,5

20-12 AWG

12

8

3 / III / I

PFT 4 1X2

8000298168

40

800 V / 32 A

4

1,5 - 4

1,5 - 4

1,5 - 4

20-10 AWG

12

8

3 / III / I

PFT 4 2X2

8000298178

30

800 V / 32 A

4

1,5 - 4

1,5 - 4

1,5 - 4

20-10 AWG

12

8

3 / III / I

Ürün Adı

Product Name

Sipariş No

Order No.

Adet

Qty.

DR 35-7,5 S 2M

8015393407

40

DR 35-15 S 2M

8015393427

20

PS 1

8010197328

50

PS 2

8010197420

50

PCC 2,5/2

8013294523

100

PCC 2,5/3

8013294533

100

PCC 2,5/10

8013294503

10

MTG 5

8020389009

500

TBSL 22X20

8020384009

1

GM1

8014393008

50

GM2

8014393018

50

TM1

8014393020

50

Ürün Adı

Product Name

Sipariş No

Order No.

Adet

Qty.

DR 35-7,5 S 2M

8015393407

40

DR 35-15 S 2M

8015393427

20

PS 1

8010197328

50

PS 2

8010197420

50

PCC 4/2

8013294623

100

PCC 4/3

8013294633

100

PCC 4/10

8013294603

10

MTG 6

8020388009

500

TBSL 22X20

8020384009

1

GM1

8014393008

50

GM2

8014393018

50

TM1

8014393020

50

Renk Kodları / Color Codes

800029806....

...6

Renk Kodları / Color Codes

800029806....

...6

*** TM1 Sadece PS2 ürünü ile Uyumludur.**

* TM1 is only suitable for PS2

**** PFT Serisi klemenslerimiz iki tarafı kapalı tipte olduğundan, nihayet plakası seçimine gerek yoktur.**

** PFT Series terminal blocks are double side closed, no need for an extra end plate usage.

Push-in Klemensleri Push-in Terminal Blocks

Çok Girişli ve Çıkışlı Topraklamalı Klemensler
Multi - Entry and Multi - Level Earth Terminal Blocks

EAC

Ürün Adı / Product Name

Sipariş No / Order No.

Paket Adeti / Packing Qty.

Anma Değerleri / Rated Values

IEC 60947-7-2

Bağlantı Bilgileri / Connection Information

Kesit / Cross-Section (mm²)

Tek Damarlı Kablo / Solid Conductor Cross-Section min mm²: (mm²)-(min-max)

Çok Damarlı Kablo / Stranded Conductor Cross-Section (mm²)-(min-max)

Çok Telli Kablo / Flexible Conductor Cross-Section (mm²)-(min-max)

AWG

Açıklamalar / Descriptions

Kablo Soyma Uzunluğu / Insulation Stripping Length (mm)

Max. Sıkma Torku (N.m) / Max. Tightening Torque

Bağlantı Vidası / Screw Diameter

Darbe Gerilimi / Rated Impulse Voltage (Kv)

Kirlilik Derecesi / Gerilim Kategorisi / Malzeme Grubu / Pollution Degree / Voltage Category / Material Group

Aksesuarlar / Accessories

Montaj Rayı / Din Rail

Durdurucu / End Stopper

Klemens Etiketleri / Marking Tags

Şerit Etiket / Strip Label

Grup Etiketleri / Group Label

PFT 2,5 1X2 E

**YENİ
NEW**

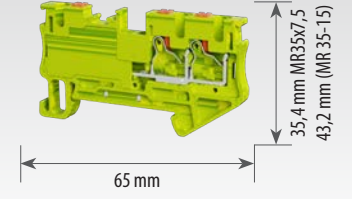

Genişlik / Width : 5,2 mm

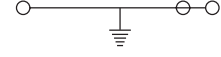

PFT 2,5 1X2 E

8001298065

40

2,5

0,5 - 2,5

0,5 - 2,5

0,5 - 2,5

20-12 AWG

12

8

3 / III / I

Ürün Adı Product Name	Sipariş No Order No.	Adet Qty.
DR 35-7,5 S 2M	8015393407	40
DR 35-15 S 2M	8015393427	20
PS 1	8010197328	50
PS 2	8010197420	50
MTG 5	8020389009	500
TBSL 22X20	8020384009	1
GM1	8014393008	50
GM2	8014393018	50
TM1	8014393020	50

* **TM1 Sadece PS2 ürünü ile uyumludur.**

* TM1 is only suitable for PS2

** **PFT Serisi klemenslerimiz iki tarafı kapalı tipte olduğundan, nihayet plakası seçimine gerek yoktur.**

** PFT Series terminal blocks are double side closed, no need for an extra end plate usage.

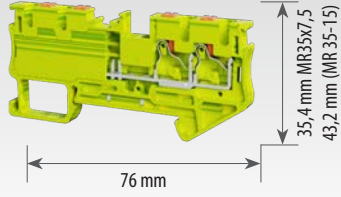
PFT 2,5 2X2 E**YENİ
NEW**

Genişlik / Width : 5,2 mm

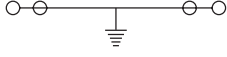
**PFT 2,5 2X2 E**

8001298066

30

2,5

0,5 - 2,5

0,5 - 2,5

0,5 - 2,5

20-12 AWG

12

8

3 / III / I

Ürün Adı Product Name	Sipariş No Order No.	Adet Qty.
DR 35-7,5 S 2M	8015393407	40
DR 35-15 S 2M	8015393427	20
PS 1	8010197328	50
PS 2	8010197420	50
MTG 5	8020389009	500
TBSL 22X20	8020384009	1
GM1	8014393008	50
GM2	8014393018	50
TM1	8014393020	50

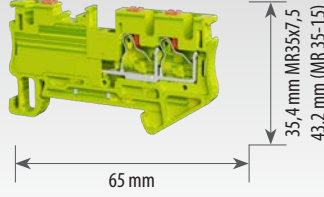
PFT 4 1X2 E**YENİ
NEW**

Genişlik / Width : 6 mm

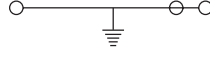
**PFT 4 1X2 E**

8001298165

40

4

1,5 - 4

1,5 - 4

1,5 - 4

20-10 AWG

12

8

3 / III / I

Ürün Adı Product Name	Sipariş No Order No.	Adet Qty.
DR 35-7,5 S 2M	8015393407	40
DR 35-15 S 2M	8015393427	20
PS 1	8010197328	50
PS 2	8010197420	50
MTG 6	8020388009	500
TBSL 22X20	8020384009	1
GM1	8014393008	50
GM2	8014393018	50
TM1	8014393020	50

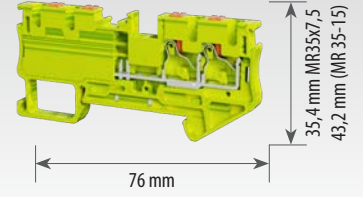
PFT 4 2X2 E**YENİ
NEW**

Genişlik / Width : 6 mm

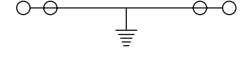
**PFT 4 2X2 E**

8001298166

30

4

1,5 - 4

1,5 - 4

1,5 - 4

20-10 AWG

12

8

3 / III / I

Ürün Adı Product Name	Sipariş No Order No.	Adet Qty.
DR 35-7,5 S 2M	8015393407	40
DR 35-15 S 2M	8015393427	20
PS 1	8010197328	50
PS 2	8010197420	50
MTG 6	8020388009	500
TBSL 22X20	8020384009	1
GM1	8014393008	50
GM2	8014393018	50
TM1	8014393020	50

* TM1 Sadece PS2 ürünü ile Uyumludur.

* TM1 is only suitable for PS2

** PFT Serisi klemenslerimiz iki tarafı kapalı tipte olduğundan, nihayet plakası seçimine gerek yoktur.

** PFT Series terminal blocks are double side closed, no need for an extra end plate usage.

Push-in Klemensleri Push-in Terminal Blocks

Çok Girişli ve Çıkışlı Bıçaklı Ayırma Klemensleri
Multi - Entry and Multi - Level Disconnect Terminal Blocks

EAC

Ürün Adı / Product Name

Sipariş No / Order No.

Paket Adeti / Packing Qty.

Anma Değerleri / Rated Values

IEC 60947-7-1

Bağlantı Bilgileri / Connection Information

Kesit / Cross-Section (mm²)

Tek Damarlı Kablo / Solid Conductor Cross-Section min mm²: (mm²)-(min-max)

Çok Damarlı Kablo / Stranded Conductor Cross-Section (mm²)-(min-max)

Çok Tellî Kablo / Flexible Conductor Cross-Section (mm²)-(min-max)

AWG

Açıklamalar / Descriptions

Kablo Soyma Uzunluğu / Insulation Stripping Length (mm)

Max. Sıkma Torku (N.m) / Max. Tightening Torque

Bağlantı Vidası / Screw Diameter

Darbe Gerilimi / Rated Impulse Voltage (Kv)

Kirlilik Derecesi / Gerilim Kategorisi / Malzeme Grubu / Pollution Degree / Voltage Category / Material Group

Aksesuarlar / Accessories

Montaj Rayı / Din Rail

Durdurucu / End Stopper

Üst Köprü / Cross Connection

Klemens Etiketi / Marking Tags

Şerit Etiket / Strip Label

Grup Etiketi / Group Label

PFT 2,5 S

**YENİ
NEW**

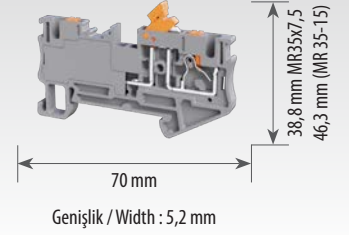

Genişlik / Width : 5,2 mm

PFT 2,5 S

8003200508

30

800 V / 24 A

2,5

0,5 - 2,5

0,5 - 2,5

0,5 - 2,5

20-12 AWG

12

8

3 / III / I

Ürün Adı Product Name	Sipariş No Order No.	Adet Qty.
DR 35-7,5 S 2M	8015393407	40
DR 35-15 S 2M	8015393427	20
PS 1	8010197328	50
PS 2	8010197420	50
PCC 2,5/2	8013294523	100
PCC 2,5/3	8013294533	100
PCC 2,5/10	8013294503	10
MTG 5	8020389009	500
TBSL 22X20	8020384009	1
GM1	8014393008	50
GM2	8014393018	50
TM1	8014393020	50

* **TM1 Sadece PS2 ürünü ile uyumludur.**

* TM1 is only suitable for PS2

** **PFT Serisi klemenslerimiz iki tarafı kapalı tipte olduğundan, nihayet plakası seçimine gerek yoktur.**

** PFT Series terminal blocks are double side closed, no need for an extra end plate usage.

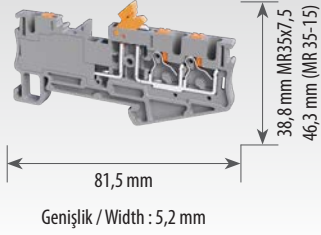
PFT 2,5 S 1X2**YENİ
NEW****PFT 2,5 S 1X2**

8003200518

30

800 V / 24 A

2,5

0,5 - 2,5

0,5 - 2,5

0,5 - 2,5

20-12 AWG

12

8

3 / III / I

Ürün Adı Product Name	Sipariş No Order No.	Adet Qty.
DR 35-7,5 S 2M	8015393407	40
DR 35-15 S 2M	8015393427	20
PS 1	8010197328	50
PS 2	8010197420	50
PCC 2,5/2	8013294523	100
PCC 2,5/3	8013294533	100
PCC 2,5/10	8013294503	10
MTG 5	8020389009	500
TBSL 22X20	8020384009	1
GM1	8014393008	50
GM2	8014393018	50
TM1	8014393020	50

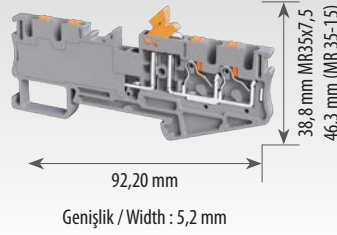
PFT 2,5 S 2X2**YENİ
NEW****PFT 2,5 S 2X2**

8003200528

30

800 V / 24 A

2,5

0,5 - 2,5

0,5 - 2,5

0,5 - 2,5

20-12 AWG

12

8

3 / III / I

Ürün Adı Product Name	Sipariş No Order No.	Adet Qty.
DR 35-7,5 S 2M	8015393407	40
DR 35-15 S 2M	8015393427	20
PS 1	8010197328	50
PS 2	8010197420	50
PCC 2,5/2	8013294523	100
PCC 2,5/3	8013294533	100
PCC 2,5/10	8013294503	10
MTG 5	8020389009	500
TBSL 22X20	8020384009	1
GM1	8014393008	50
GM2	8014393018	50
TM1	8014393020	50

* **TM1 Sadece PS2 ürünü ile Uyumludur.**

* TM1 is only suitable for PS2

** **PFT Serisi klemenslerimiz iki tarafı kapalı tipte olduğundan, nihayet plakası seçimine gerek yoktur.**

** PFT Series terminal blocks are double side closed, no need for an extra end plate usage.

Push-in Klemensleri Push-in Terminal Blocks

Çok Girişli ve Çıkışlı Klemensler Multi - Entry and Multi - Level Terminal Blocks



Ürün Adı / Product Name
Sipariş No / Order No.
Paket Adeti / Packing Qty.
Anma Değerleri / Rated Values
IEC 60947-7-1 / IEC 60947-7-2 (PFT 2,5 2P+E)
Bağlantı Bilgileri / Connection Information
Kesit / Cross-Section (mm²)
Tek Damarlı Kablo / Solid Conductor Cross-Section min mm²: (mm²)-(min-max)
Çok Damarlı Kablo / Stranded Conductor Cross-Section (mm²)-(min-max)
Çok Tellî Kablo / Flexible Conductor Cross-Section (mm²)-(min-max)
AWG
Açıklamalar / Descriptions
Kablo Soyma Uzunluğu / Insulation Stripping Length (mm)
Max. Sıkma Torku (N.m) / Max. Tightening Torque
Bağlantı Vidası / Screw Diameter
Darbe Gerilimi / Rated Impulse Voltage (Kv)
Kirlilik Derecesi / Gerilim Kategorisi / Malzeme Grubu / Pollution Degree / Voltage Category / Material Group
Aksesuarlar / Accessories
Montaj Rayı / Din Rail
Durdurucu / End Stopper
Üst Köprü / Cross Connection
Klemens Etiketleri / Marking Tags
Şerit Etiket / Strip Label
Grup Etiketleri / Group Label

PFT 2,5 2P		
Genişlik / Width : 5,2 mm		
PFT 2,5 2P		
8002298098		
50		
500 V / 24 A		
2,5		
0,5 - 2,5		
0,5 - 2,5		
0,5 - 2,5		
20-12 AWG		
12		
8		
3 / III / I		
Ürün Adı Product Name	Sipariş No Order No.	Adet Qty.
DR 35-7,5 S 2M	8015393407	40
DR 35-15 S 2M	8015393427	20
PS 1	8010197328	50
PS 2	8010197420	50
PCC 2,5/2	8013294523	100
PCC 2,5/3	8013294533	100
PCC 2,5/10	8013294503	10
MTG 5	8020389009	500
TBSL 22X20	8020384009	1
GM1	8014393008	50
GM2	8014393018	50
TM1	8014393020	50

* **TM1 Sadece PS2 ürünü ile Uyumludur.**

* TM1 is only suitable for PS2

** **PFT Serisi klemenslerimiz iki tarafı kapalı tipte olduğundan, nihayet plakası seçimine gerek yoktur.**

** PFT Series terminal blocks are double side closed, no need for an extra end plate usage.

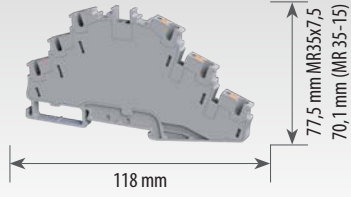
PFT 2,5 3PYENİ
NEW

Genişlik / Width : 5,15 mm

**PFT 2,5 3P**

8002298198

28

500 V / 24 A

2,5

0,5 - 4

0,5 - 4

0,5 - 4

20 - 12 AWG

12

6

3 / III / I

Ürün Adı Product Name	Sipariş No Order No.	Adet Qty.
DR 35-7,5 S 2M	8015393407	40
DR 35-15 S 2M	8015393427	20
PS 1	8010197328	50
PS 2	8010197420	50
PCC 2,5/2	8013294523	100
PCC 2,5/3	8013294533	100
PCC 2,5/10	8013294503	10
MTG 5	8020389009	500
TBSL 22X20	8020384009	1
GM1	8014393008	50
GM2	8014393018	50
TM1	8014393020	50

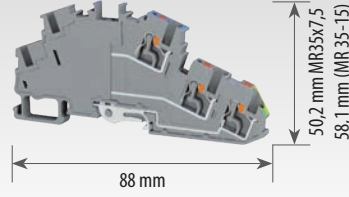
PFT 2,5 2P+E

Genişlik / Width : 5,2 mm

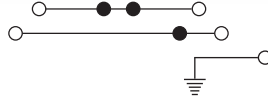
**PFT 2,5 2P+E**

8002298108

30

500 V / 24 A

2,5

0,5 - 2,5

0,5 - 2,5

0,5 - 2,5

20-12 AWG

12

8

3 / III / I

Ürün Adı Product Name	Sipariş No Order No.	Adet Qty.
DR 35-7,5 S 2M	8015393407	40
DR 35-15 S 2M	8015393427	20
PS 1	8010197328	50
PS 2	8010197420	50
PCC 2,5/2	8013294523	100
PCC 2,5/3	8013294533	100
PCC 2,5/10	8013294503	10
MTG 5	8020389009	500
TBSL 22X20	8020384009	1
GM1	8014393008	50
GM2	8014393018	50
TM1	8014393020	50

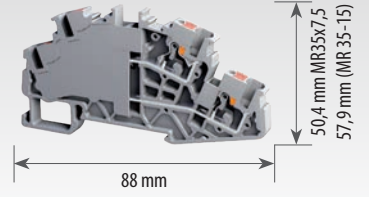
PFT 4 2P

Genişlik / Width : 6 mm

**PFT 4 2P**

8002298118

50

500 V / 32 A

4

1,5 - 4

1,5 - 4

1,5 - 4

20-10 AWG

12

8

3 / III / I

Ürün Adı Product Name	Sipariş No Order No.	Adet Qty.
DR 35-7,5 S 2M	8015393407	40
DR 35-15 S 2M	8015393427	20
PS 1	8010197328	50
PS 2	8010197420	50
PCC 4/2	8013294623	100
PCC 4/3	8013294633	100
PCC 4/10	8013294603	10
MTG 5	8020389009	500
TBSL 22X20	8020384009	1
GM1	8014393008	50
GM2	8014393018	50
TM1	8014393020	50

Renk Kodları / Color Codes

800029819.... ..8 ...6

* **TM1 Sadece PS2 ürünü ile Uyumludur.**

* TM1 is only suitable for PS2

** **PFT Serisi klemenslerimiz iki tarafı kapalı tipte olduğundan, nihayet plakası seçimine gerek yoktur.**

** PFT Series terminal blocks are double side closed, no need for an extra end plate usage.

Push-in Klemensleri Push-in Terminal Blocks

Push-In Sigortalı Klemens Push-In Type Fuse Terminal Blocks



Ürün Adı / Product Name

Sipariş No / Order No.

Paket Adeti / Packing Qty.

Anma Değerleri / Rated Values

IEC 60947-7-1 / IEC 60947-7-2 (PFT 2,5 2P+E)

Bağlantı Bilgileri / Connection Information

Kesit / Cross-Section (mm²)

Tek Damarlı Kablo / Solid Conductor Cross-Section min mm²: (mm²)-(min-max)

Çok Damarlı Kablo / Stranded Conductor Cross-Section (mm²)-(min-max)

Çok Tellî Kablo / Flexible Conductor Cross-Section (mm²)-(min-max)

AWG

Açıklamalar / Descriptions

Kablo Soyma Uzunluğu / Insulation Stripping Length (mm)

Max. Sıkma Torku (N.m) / Max. Tightening Torque

Darbe Gerilimi / Rated Impulse Voltage (Kv)

Kirlilik Derecesi / Gerilim Kategorisi / Malzeme Grubu / Pollution Degree / Voltage Category / Material Group

Aksesuarlar / Accessories

Montaj Rayı / Din Rail

Durdurucu / End Stopper

Üst Köprü / Cross Connection

Klemens Etiketi / Marking Tags

Grup Etiketi / Group Label

PFT 4 F

YENİ
NEW

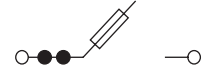
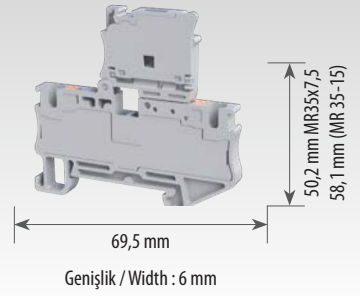

PFT 4 F

8003298488

70

500 V / 6.3A

4

0,5 - 6

0,5 - 2,5

0,5 - 2,5

20-10 AWG

12

0,8

8

3 / III / I

Ürün Adı Product Name	Sipariş No Order No.	Adet Qty.
DR 35-7,5 S 2M	8015393407	40
DR 35-15 S 2M	8015393427	20
PS 1	8010197328	50
PS 2	8010197420	50
PCC 4/2	8013294623	100
PCC 4/3	8013294633	100
PCC 4/10	8013294603	10
MTG 6	8020388009	500
GM1	8014393008	50
GM2	8014393018	50
TM1	8014393020	50

Renk Kodları / Color Codes

800329848....

...8

...6

* TM1 Sadece PS2 ürünü ile uyumludur.

* TM1 is only suitable for PS2

** PFT Serisi klemenslerimiz iki tarafı kapalı tipte olduğundan, nihayet plakası seçimine gerek yoktur.

** PFT Series terminal blocks are double side closed, no need for an extra end plate usage.

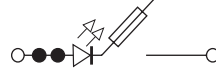
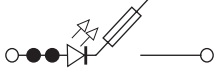
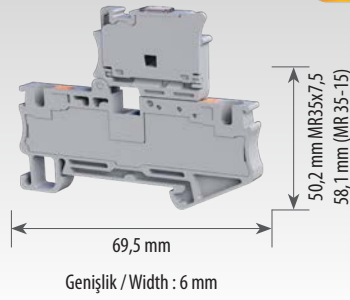
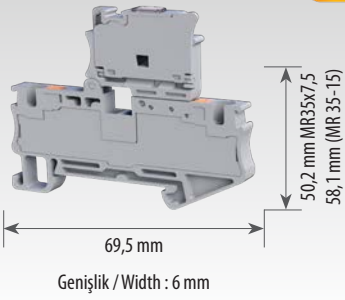
PFT 4 F LD (24-48VAC/DC)**PFT 4 F LD (110-220VAC/DC)****PFT 4 F LD (24-48 VAC/DC)**

8003298498

70

24-48 VAC / DC

4

0,5 - 6

0,5 - 4

0,5 - 4

20-10 AWG

12

0,8

6

3 / III / I

PFT 4 F LD (110-220 VAC/DC)

8003298508

70

110-220 VAC / DC

4

0,5 - 6

0,5 - 4

0,5 - 4

20-10 AWG

12

0,8

6

3 / III / I

Ürün Adı Product Name	Sipariş No Order No.	Adet Qty.
DR 35-7,5 S 2M	8015393407	40
DR 35-15 S 2M	8015393427	20
PS 1	8010197328	50
PS 2	8010197420	50
PCC 4/2	8013294623	100
PCC 4/3	8013294633	100
PCC 4/10	8013294603	10
MTG 6	8020388009	500
GM1	8014393008	50
GM2	8014393018	50
TM1	8014393020	50

Ürün Adı Product Name	Sipariş No Order No.	Adet Qty.
DR 35-7,5 S 2M	8015393407	40
DR 35-15 S 2M	8015393427	20
PS 1	8010197328	50
PS 2	8010197420	50
PCC 4/2	8013294623	100
PCC 4/3	8013294633	100
PCC 4/10	8013294603	10
MTG 6	8020388009	500
GM1	8014393008	50
GM2	8014393018	50
TM1	8014393020	50

Renk Kodları / Color Codes

800329848....

...8

...6

Renk Kodları / Color Codes

800329848....

...8

...6

**Sigorta Tipi Bakır Bara
Fuse Shaped Copper Bar**

Ürün Adı Product Name	Sipariş No Order No.	Adet Qty.
FSCB 5x20	8014401100	10

**Mini Cam Sigorta
Mini Glass Fuse**

Ürün Adı Product Name	Sipariş No Order No.	Adet Qty.
MGF 0,05A	8014401200	10
MGF 0,25A	8014401210	10
MGF 0,5A	8014401220	10
MGF 1A	8014401230	10
MGF 2A	8014401240	10
MGF 2,5A	8014401250	10
MGF 3,15A	8014401260	10
MGF 4A	8014401270	10
MGF 5A	8014401280	10
MGF 6,3A	8014401290	10

* TM1 Sadece PS2 ürünü ile Uyumludur.

* TM1 is only suitable for PS2

** PFT Serisi klemenslerimiz iki tarafı kapalı tipte olduğundan, nihayet plakası seçimine gerek yoktur.

** PFT Series terminal blocks are double side closed, no need for an extra end plate usage.

Sıra Klemensleri

Terminal Strips

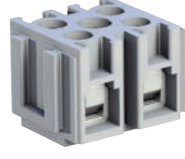

CSK 2,5



SRK 16/3



SRK 16/8



Ürün Adı Product Name	Sipariş No Order No.	Gerilim (V) Voltage (V)	Akım (A) Current (A)	Kesit (mm ²) Cross Section (mm ²)	Kutup Sayısı Number of Poles	Vida Clamping Screw	Tork (Nm) Torque (Nm)	Paket Adeti Packing Qty.
SRK 16/2	8006097008	750	76	2,5	2	M 5	2	96
SRK 16/3	8006097018	750	76	2,5	3	M 5	2	32
SRK 16/4	8006097028	750	76	2,5	4	M 5	2	48
SRK 16/5	8006097038	750	76	2,5	5	M 5	2	32
SRK 16/6	8006097048	750	76	2,5	6	M 5	2	30
SRK 16/8	8006097058	750	76	2,5	8	M 5	2	24
SRK 16/10	8006097068	750	76	2,5	10	M 5	2	16
SRK 16/12	8006097078	750	76	2,5	12	M 5	2	8
CSK 2,5	8006097108	500	24	2,5	2	M 2,5	0,4 - 0,6	100
CSK 6	8006097118	800	41	6	2	M 3,5	0,8 - 1,2	60

Durdurucular

End Bracket

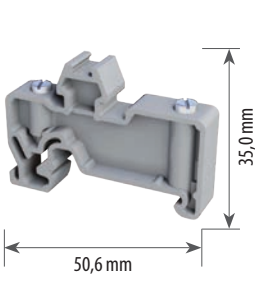

Genişlik / Width : 9,5 mm

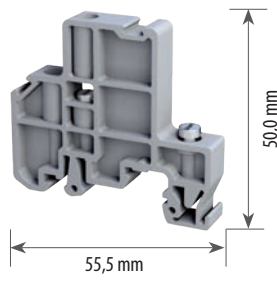

Genişlik / Width : 10,0 mm

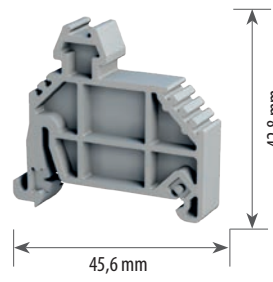

Genişlik / Width : 10,0 mm

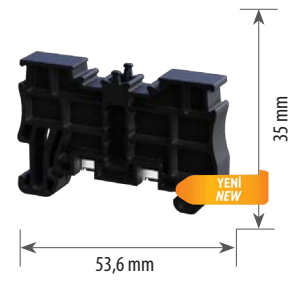

Genişlik / Width : 8,0 mm

Ürün Adı Product Name	SS 1
Sipariş No Order No.	8010097308
Montaj Fixing	Vidalı Screw Type
Renk Color	Gri Gray
Ray Rail	MR 35
Etiket Marker	MTG 5
Paket Adeti Packing Qty.	50

Ürün Adı Product Name	SS 2
Sipariş No Order No.	8010097318
Montaj Fixing	Vidalı Screw Type
Renk Color	Gri Gray
Ray Rail	MR 35 MR 32
Etiket Marker	MTG 5
Paket Adeti Packing Qty.	50

Ürün Adı Product Name	PS 1
Sipariş No Order No.	8010197328
Montaj Fixing	Push in Push in
Renk Color	Gri Gray
Ray Rail	MR 35
Etiket Marker	MTG 5
Paket Adeti Packing Qty.	50

Ürün Adı Product Name	PS 2
Sipariş No Order No.	8010197420
Montaj Fixing	Push in Push in
Renk Color	Siyah Black
Ray Rail	MR 35
Etiket Marker	MTG 5
Paket Adeti Packing Qty.	50

Grup Etiketi

Group Marker

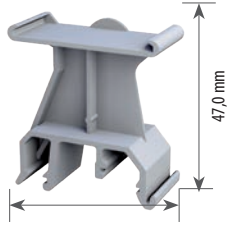

43,7 mm
Genişlik / Width : 19,5 mm

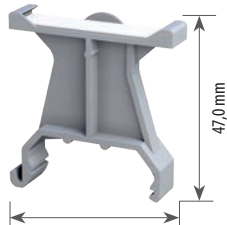

44,4 mm
Genişlik / Width : 9,5 mm

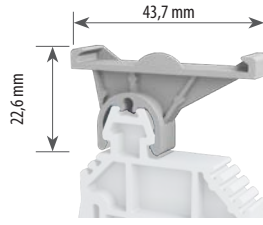

Genişlik / Width : 9,5 mm

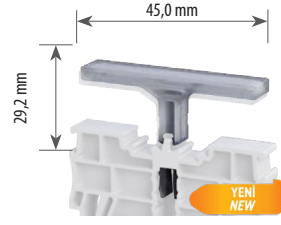

Genişlik / Width : 8,0 mm

Ürün Adı Product Name	GM 1
Sipariş No Order No.	8014393008
Renk Color	Gri / Gray
Ray Rail	MR 35
Paket Adeti Packing Qty.	50

Ürün Adı Product Name	GM 2
Sipariş No Order No.	8014393018
Renk Color	Gri / Gray
Ray Rail	MR 32 - MR 35
Paket Adeti Packing Qty.	50

Ürün Adı Product Name	SL 1
Sipariş No Order No.	8012396008
Renk Color	Gri / Gray
Paket Adeti Packing Qty.	50

Ürün Adı Product Name	TM 1
Sipariş No Order No.	8014393020
Renk Color	Şeffaf / Transparent
Paket Adeti Packing Qty.	50
TM1 Sadece PS2 ürünü ile Uyumludur. TM1 is only suitable for PS2	

Etiket Şemsiyesi

Marker Holder



* LHO Sadece TBL serisi ile Uyumludur.
* LHO is only suitable for TBL series

Ürün Adı Product Name	LHO
Sipariş No Order No.	8020390009
Etiket Marker	TBSL 22x20
Paket Adeti Packing Qty.	10

Köprü Tutucu (TDV 6 için)

Marker Holder (Only TDV 6)



Ürün Adı Product Name	JH - TDV
Sipariş No Order No.	8014001003
Açıklama Explanation	TDV Serisi Üst Köprü Tutucu TDV Jumper Holder
Paket Adeti Packing Qty.	1

Nihayet Plakaları

End Plates



Ürün Adı Product Name	EPL NTB 2,5-10	EPL NTB 2,5-10 E	EPL NTB 2,5-4 2P	EPL NTB 4 P+F Gri	EPL NTB 2,5-4 2P E
Sipariş No Order No.	8012396288	8012396284	8012396388	8012396588	8012396384
Renk Color	Gri / Gray	Sarı-Yeşil / Yellow-Green	Gri / Gray	Gri / Gray	Sarı-Yeşil / Yellow-Green
Kullanıldığı Klemens Used with	NTB 2,5, NTB 4, NTB 6, NTB 10	NTB 2,5 E, NTB 4 E, NTB 6 E, NTB 10 E	NTB 2,5 2P, EPL NTB 2,5 P + E, NTB 4 2P	NTB 4 F+P	NTB 2,5 2P E - 4 2P E
Paket Adeti Packing Qty.	50	50	20	20	20

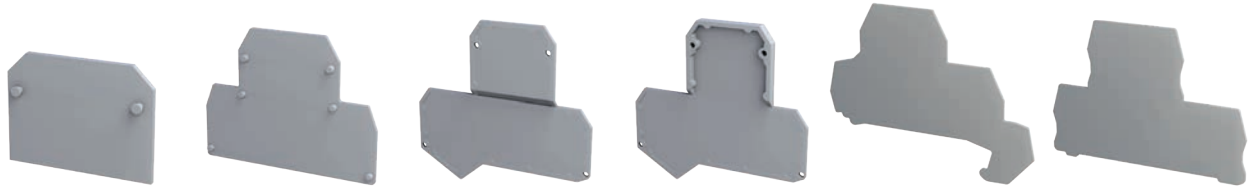

Ürün Adı Product Name	EPL TBL 2,5-10	EPL TBL 2,5-4 2P	EPL1 TBL 4 2P	EPL 2 TBL 4 2P	EPL TBL 2,5-2P+E	EPL TBL 10 2P
Sipariş No Order No.	8012396118	8012396208	8012396218	8012396228	8012396158	8012396298
Renk Color	Gri / Gray	Gri / Gray	Gri / Gray	Gri / Gray	Gri / Gray	Gri / Gray
Kullanıldığı Klemens Used with	TBL 2,5, TBL 4, TBL 6 TBL 10	TBL 2,5-4 2P	TBL 4 2P	TBL 4 2P	TBL 2,5 - 2P+E	TBL 10 2P
Paket Adeti Packing Qty.	50	20	20	20	20	20



Ürün Adı Product Name	EPL TDS	EPL TDV	EPL TDY
Sipariş No Order No.	8012396018	8012396028	8012396038
Renk Color	Gri / Gray	Gri / Gray	Gri / Gray
Kullanıldığı Klemens Used with	TDS - C 6, TDS - V 6	TDV - C 6, TDS - V 6	TDY - C 6, TDY - C 6-1
Paket Adeti Packing Qty.	50	50	50

Koruma Kapakları

Isolation Covers

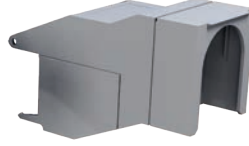

Ürün Adı Product Name	C-TBB 70-95-150	C-TBB 240
Sipariş No Order No.	8012396608	8012396618
Renk Color	Gri / Gray	Gri / Gray
Kullanıldığı Klemens Used with	TBB 70-95-150	TBB 240
Paket Adeti Packing Qty.	8	10

Ayırma Plakaları

Partition Plates

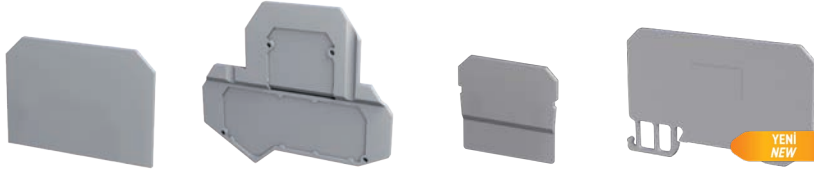

Ürün Adı Product Name	PRTBL 2,5-10	PR TBL 4 2P	SPR 2,5-10	PR PFT
Sipariş No Order No.	8012396408 8012396406	8012396508	8012396528	8012397038
Renk Color	Gri / Gray	Gri / Gray	Gri / Gray	Gri / Gray
Kullanıldığı Klemens Used with	TBL 4, TBL 6, TBL 10	TBL 4 2P	TBL 2,5, TBL 4, TBL 6, TBL 10	2,5-10 NTB - PFT Serisi NTB - PFT Series
Paket Adeti Packing Qty.	50	20	100	50

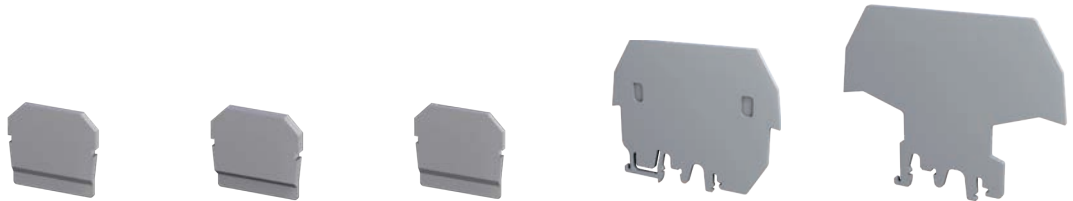

Ürün Adı Product Name	SPR 16-35	SPR 50	SPR TBL 4 2P	GPR	CHO
Sipariş No Order No.	8012396538	8012396548	8012396558	8012396568 8012396566	8012396578
Renk Color	Gri / Gray	Gri / Gray	Gri / Gray	Gri / Gray	Gri / Gray
Kullanıldığı Klemens Used with	TBL 16, TBL 35	TBL 50	TBL 4 2P	TBL 16, TBL 35, TBL 50	TBL 16, TBL 35, TBL 50
Paket Adeti Packing Qty.	50	50	100	20	20

Push-in Üst Köprüler

Push-in Cross Connections

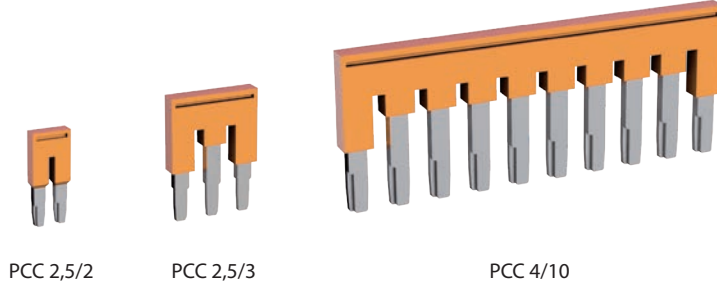

PCC 2,5/2

PCC 2,5/3

PCC 4/10

Sipariş No Order No.	Ürün Adı Product Name	Birlikte Kullanıldığı Klemens Used in Terminal	Kutup Sayısı Pole	Kesit (mm ²) Cross Section (mm ²)	Amb. Mik. Pack. Qty (Adet/Pcs.)
8013294523	PCC 2,5/2	PFT 2,5, PFT 2,5 1x2, PFT 2,5 2x2, PFT 2,5 2P, PFT 2,5 E, NTB 2,5	2	2,5	100
8013294533	PCC 2,5/3	PFT 2,5, PFT 2,5 1x2, PFT 2,5 2x2, PFT 2,5 2P, PFT 2,5 E, NTB 2,5	3	2,5	100
8013294503	PCC 2,5/10	PFT 2,5, PFT 2,5 1x2, PFT 2,5 2x2, PFT 2,5 2P, PFT 2,5 E, NTB 2,5	10	2,5	10
8013294623	PCC 4/2	PFT 4, NTB 4	2	4	100
8013294633	PCC 4/3	PFT 4, NTB 4	3	4	100
8013294603	PCC 4/10	PFT 4, NTB 4	10	4	10
8013294723	PCC 6/2	PFT 6, NTB 6	2	6	50
8013294733	PCC 6/3	PFT 6, NTB 6	3	6	50
8013294703	PCC 6/10	PFT 6	10	6	10
8013295723	PCC 6/2-T	NTB 6, TDV 6	2	6	50
8013295733	PCC 6/3-T	NTB 6, TDV 6	3	6	50
8013295703	PCC 6/10-T	NTB 6, TDV 6	10	6	10
8013294823	PCC 10/2	PFT 10, NTB 10	2	10	10
8013294833	PCC 10/3	PFT 10, NTB 10	3	10	10
8013294923	PCC 16/2	PFT 16	2	16	10

PFT ve NTB Klemens Gruplarında Ortak Kullanım: PCC Geçme Tip Üst Köprüler ile Pratik Uygulamalar

Common Use for PFT and NTB Terminal Blocks Groups:
Practical Applications with PCC Type Plug-in Cross Connections

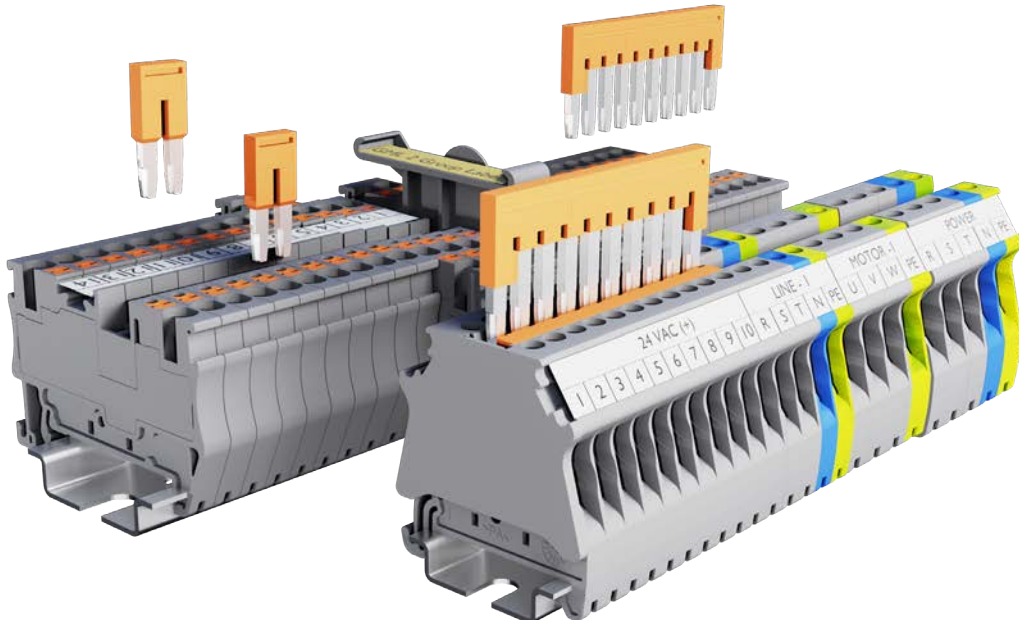

Vidalı Üst Köprüler

Cross Connections



Sipariş No Order No.	Ürün Adı Product Name	Birlikte Kullanıldığı Klemens Used in Terminal	Kutup Sayısı Pole	Kesit (mm ²) Cross Section (mm ²)	Amb. Mik. Pack. Qty (Adet/Pcs.)
8013095023	SCC 2,5/2	TBL 2,5, TBL 2,5-4 2P	2	2,5	50
8013095033	SCC 2,5/3	TBL 2,5, TBL 2,5-4 2P	3	2,5	50
8013095003	SCC 2,5/10	TBL 2,5, TBL 2,5-4 2P	10	2,5	10
8013095123	SCC 4/2	TBL 4, TBL 4 2P	2	4	50
8013095133	SCC 4/3	TBL 4, TBL 4 2P	3	4	50
8013095103	SCC 4/10	TBL 4, TBL 4 2P	10	4	10
8013095223	SCC 6/2	TBL 6	2	6	50
8013095233	SCC 6/3	TBL 6	3	6	50
8013095203	SCC 6/10	TBL 6	10	6	10
8013095323	SCC 10/2	TBL 10	2	6	50
8013095333	SCC 10/3	TBL 10	3	10	50
8013095303	SCC 10/10	TBL 10	10	10	10
8013095423	SCC 16/2	TBL 16	2	10	20
8013095433	SCC 16/3	TBL 16	3	16	20
8013095403	SCC 16/10	TBL 16	10	16	10
8013095523	SCC 25/2	TBL 25	2	16	20
8013095533	SCC 25/3	TBL 25	3	25	20
8013095503	SCC 25/10	TBL 25	10	25	10
8013095623	SCC 35/2	TBL 35	2	25	20
8013095633	SCC 35/3	TBL 35	3	35	20
8013095603	SCC 35/10	TBL 35	10	35	10
8013095723	SCC 50/2	TBL 50	2	50	10
8013095733	SCC 50/3	TBL 50	3	50	10
8013095823	SCC 70/2	TBL 70	2	70	10
8013095833	SCC 70/3	TBL 70	3	70	10
8013095923	SCC 95/2	TBL 95	2	95	10
8013095933	SCC 95/3	TBL 95	3	95	10
8013094023	SCC 150/2	TBL 150	2	150	10
8013094123	SCC 4/2 TBL 4 2P	TBL 4 2P	2	4	50
8013094133	SCC 4/3 TBL 4 2P	TBL 4 2P	3	4	50
8013094163	SCC 4/6 TBL 4 2P	TBL 4 2P	6	4	20
8013094103	SCC 4/10 TBL 4 2P	TBL 4 2P	10	4	10

Tarak Köprüler

Comb Connector



TCC 4/3

TCC 4/10

Sipariş No Order No.	Ürün Adı Product Name	Birlikte Kullanıldığı Klemens Used in Terminal	Pin Pole	Kesit (mm ²) Cross Section (mm ²)	Renk Color	Amb. Mik. Pack. Qty (Adet/Pcs.)
8013094223	TCC 2,5/2	TBL 2,5, TBL 2,5-4 2P, TBL 2,5-4 2PK, TBL 2,5-4 2P+E NTB 2,5	2	2,5	Gri/ Grey	50
8013094203	TCC 2,5/3	TBL 2,5, TBL 2,5-4 2P, TBL 2,5-4 2PK, TBL 2,5-4 2P+E NTB 2,5	3	2,5	Gri/ Grey	50
8013094233	TCC 2,5/10	TBL 2,5, TBL 2,5-4 2P, TBL 2,5-4 2PK, TBL 2,5-4 2P+E, NTB 2,5	10	2,5	Gri/ Grey	10
8013094323	TCC 4/2	TBL 4, NTB 4	2	4	Gri/ Grey	50
8013094333	TCC 4/3	TBL 4, NTB 4	3	4	Gri/ Grey	50
8013094303	TCC 4/10	TBL 4, NTB 4	10	4	Gri/ Grey	10
8013394823	TCC 6/2	FDT 4, FDT 4L, TDT-C6, TDT-V6, TDS-C6, TDV-C6, TDS-V6, TDY-C6, NTB 6, TDV 6	2	6	Gri/ Grey	50
8013394833	TCC 6/3	FDT 4, FDT 4L, TDT-C6, TDT-V6, TDS-C6, TDV-C6, TDS-V6, TDY-C6, TDV 6	3	6	Gri/ Grey	50
8013394803	TCC 6/10	FDT 4, FDT 4L, TDT-C6, TDT-V6, TDS-C6, TDV-C6, TDS-V6, TDY-C6, TDV 6	10	6	Gri/ Grey	10

Kayar Köprüler

Sliding Connector



SLC 2

SLC-R 4

PCC 6/10-T

Sipariş No Order No.	Ürün Adı Product Name	Birlikte Kullanıldığı Klemens Used in Terminal	Kutup Sayısı Pole	Kesit (mm ²) Cross Section (mm ²)	Amb. Mik. Pack. Qty (Adet/Pcs.)
8013394923	SLC 2	TDT-C 6, TDT-V 6, TDS-C 6, TDS-V 6	2	6	50
8013394933	SLC 3	TDT-C 6, TDT-V 6, TDS-C 6, TDS-V 6	3	6	50
8013394943	SLC 4	TDT-C 6, TDT-V 6, TDS-C 6, TDS-V 6	4	6	50
8014393307	SLC-R 2	TDY-C 6	2	6	50
8014393317	SLC-R 3	TDY-C 6	3	6	50
8014393327	SLC-R 4	TDY-C 6	4	6	50
8013295723	PCC 6/2-T	TDV 6, NTB 6	2	6	50
8013295733	PCC 6/3-T	TDV 6, NTB 6	3	6	50
8013295703	PCC 6/10-T	TDV 6, NTB 6	10	6	10

Test Fişleri

Test Sockets



TST 4

TST 2

TST 1

Sipariş No Order No.	Ürün Adı Product Name	Birlikte Kullanıldığı Klemens Used in Terminal	Renk Color	Amb. Mik. Pack. Qty (Adet/Pcs.)
8014393106	TST-I 1	TBL 6, TBL 10, TDT-C, TDT-V, TDS-C, TDS-V	Mavi / Blue	50
8014393104	TST-I 1	TBL 6, TBL 10, TDT-C, TDT-V, TDS-C, TDS-V	Sarı / Yellow	50
8014393108	TST-I 1	TBL 6, TBL 10, TDT-C, TDT-V, TDS-C, TDS-V	Gri / Gray	50
8014393102	TST-I 1	TBL 6, TBL 10, TDT-C, TDT-V, TDS-C, TDS-V	Kırmızı / Red	50
8014393100	TST-I 1	TBL 6, TBL 10, TDT-C, TDT-V, TDS-C, TDS-V	Siyah / Black	50
8014393227	TST 1	TBL 2,5, TBL 4, TBL 2,5-4 2P, TBL 4 2P, TBL 2,5 3P		50
8014393237	TST 2	TBL 10		50
8014393247	TST 3	TBL 16		50
8014393257	TST 4	TBL 25, TBL 35		50
8014394250	TFT 4	TDV 6	Siyah / Black	10

Klemens Etiketleri

Marking Tags



MTG 5 Baskılı



MTG 5 Baskısız

Ürün Kodu Product Code	Ürün Adı Product Name	Açıklama Description	Amb. Mik. Pack. Qty (Etiket - Tags / Pcs.)
8020389019	MTG 5 Baskılı	Baskılı / Printed	500
8020389009	MTG 5 Baskısız	Boş / Empty	500
8020389029	MTG 5 (1-10)	1-10	500
8020389039	MTG 5 (11-20)	11-20	500
8020389049	MTG 5 (21-30)	21-30	500
8020389059	MTG 5 (31-40)	31-40	500
8020389069	MTG 5 (41-50)	41-50	500
8020389079	MTG 5 (51-60)	51-60	500
8020389089	MTG 5 (61-70)	61-70	500
8020389099	MTG 5 (71-80)	71-80	500
8020389109	MTG 5 (81-90)	81-90	500
8020389119	MTG 5 (91-100)	91-100	500
8020389129	MTG 5 (1-50)	1-50	500
8020389139	MTG 5 (51-100)	51-100	500
8020389149	MTG 5 (101-150)	101-150	500
8020389159	MTG 5 (151-200)	151-200	500
8020389169	MTG 5 (201-250)	201-250	500
8020389179	MTG 5 (251-300)	251-300	500
8020389189	MTG 5 (301-350)	301-350	500
8020389199	MTG 5 (351-400)	351-400	500
8020389209	MTG 5 (401-450)	401-450	500
8020389219	MTG 5 (451-500)	451-500	500
8020388019	MTG 6 Baskılı	Baskılı / Printed	500
8020388009	MTG 6 Baskısız	Boş / Empty	500
8020388839	MTG 6 (L1, L2, L3, N)	L1, L2, L3, N	500
8020388309	MTG 6 (0)	0	500
8020388319	MTG 6 (1)	1	500
8020388599	MTG 6 (5)	5	500
8020388329	MTG 6 (2)	2	500
8020388339	MTG 6 (3)	3	500
8020388349	MTG 6 (4)	4	500
8020388359	MTG 6 (5)	5	500
8020388369	MTG 6 (6)	6	500
8020388379	MTG 6 (7)	7	500
8020388389	MTG 6 (8)	8	500
8020388399	MTG 6 (9)	9	500
8020388409	MTG 6 (10)	10	500
8020388029	MTG 6 (0-9)	0-9	500
8020388039	MTG 6 (1-10)	1-10	500
8020388879	MTG 6 (11-20)	11-20	500
8020388889	MTG 6 (21-30)	21-30	500
8020388899	MTG 6 (31-40)	31-40	500
8020388909	MTG 6 (41-50)	41-50	500
8020388919	MTG 6 (51-60)	51-60	500
8020388929	MTG 6 (61-70)	61-70	500
8020388939	MTG 6 (71-80)	71-80	500
8020388949	MTG 6 (81-90)	81-90	500
8020388959	MTG 6 (91-100)	91-100	500
8020388049	MTG 6 (1-50)	1-50	500
8020388059	MTG 6 (51-100)	51-100	500

Klemens Etiketleri

Marking Tags

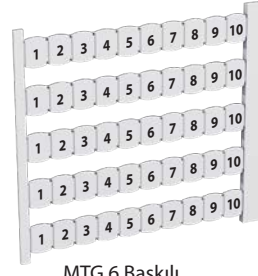

MTG 6 Baskılı



MTG 6 Baskısız

Ürün Kodu Product Code	Ürün Adı Product Name	Açıklama Description	Amb. Mik. Pack. Qty (Etiket - Tags / Pcs.)
8020388069	MTG 6 (101-150)	101-150	500
8020388079	MTG 6 (151-200)	151-200	500
8020388089	MTG 6 (201-250)	201-250	500
8020388099	MTG 6 (251-300)	251-300	500
8020388109	MTG 6 (301-350)	301-350	500
8020388119	MTG 6 (351-400)	351-400	500
8020388129	MTG 6 (401-450)	401-450	500
8020388139	MTG 6 (451-500)	451-500	500
8020388149	MTG 6 (501-550)	501-550	500
8020388159	MTG 6 (551-600)	551-600	500
8020388169	MTG 6 (601-650)	601-650	500
8020388179	MTG 6 (651-700)	651-700	500
8020388189	MTG 6 (701-750)	701-750	500
8020388199	MTG 6 (751-800)	751-800	500
8020388209	MTG 6 (801-850)	801-850	500
8020388219	MTG 6 (851-900)	851-900	500
8020388229	MTG 6 (901-950)	901-950	500
8020388239	MTG 6 (951-1000)	951-1000	500
8020388859	MTG 6 (RSTN)	RSTN	500
8020388779	MTG 6 (+)	+	500
8020388789	MTG 6 (-)	-	500
8020388429	MTG 6 (B)	B	500
8020388849	MTG 6 (PE)	PE	500
8020388459	MTG 6 (E)	E	500
8020388529	MTG 6 (L)	L	500
8020388549	MTG 6 (N)	N	500
8020388659	MTG 6 (Y)	Y	500
8020388589	MTG 6 (R)	R	500
8020388829	MTG 6 (L1, L2, L3)	L1, L2, L3	500
8020388799	MTG 6 (L1)	L1	500
8020388809	MTG 6 (L2)	L2	500
8020388499	MTG 6 (I)	I	500
8020388449	MTG 6 (D)	D	500
8020388519	MTG 6 (K)	K	500
8020388469	MTG 6 (F)	F	500
8020388419	MTG 6 (A)	A	500
8020388539	MTG 6 (M)	M	500
8020388569	MTG 6 (P)	P	500
8020388679	MTG 6 (X1)	X1	500
8020388689	MTG 6 (X2)	X2	500
8020388699	MTG 6 (X3)	X3	500
8020388709	MTG 6 (X4)	X4	500
8020388719	MTG 6 (X5)	X5	500
8020388729	MTG 6 (X6)	X6	500
8020388739	MTG 6 (X7)	X7	500
8020388749	MTG 6 (X8)	X8	500
8020388759	MTG 6 (X9)	X9	500
8020388769	MTG 6 (X10)	X10	500
8020388439	MTG 6 (C)	C	500
8020388629	MTG 6 (V)	V	500

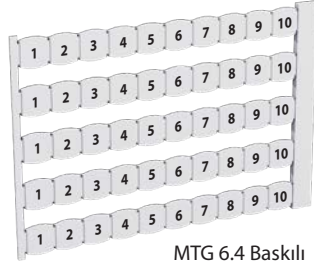

MTG 6.4 Baskılı



MTG 6.4 Baskısız

Ürün Kodu Product Code	Ürün Adı Product Name	Açıklama Description	Amb. Mik. Pack. Qty (Etiket - Tags / Pcs.)
8020388479	MTG 6 (G)	G	500
8020388489	MTG 6 (H)	H	500
8020388819	MTG 6 (L3)	L3	500
8020388869	MTG 6 (MP)	MP	500
8020388609	MTG 6 (T)	T	500
8020387019	MTG 6,4 Baskılı	Baskılı / Printed	500
8020387009	MTG 6,4 Baskısız	Boş / Empty	500
8020387309	MTG 6,4 (1)	1	500
8020387319	MTG 6,4 (2)	2	500
8020387329	MTG 6,4 (3)	3	500
8020387339	MTG 6,4 (4)	4	500
8020387349	MTG 6,4 (5)	5	500
8020387359	MTG 6,4 (6)	6	500
8020387369	MTG 6,4 (7)	7	500
8020387379	MTG 6,4 (8)	8	500
8020387389	MTG 6,4 (9)	9	500
8020387399	MTG 6,4 (10)	10	500
8020387030	MTG 6,4 (1-10)	1-10	500
8020387031	MTG 6,4 (11-20)	11-20	500
8020387032	MTG 6,4 (21-30)	21-30	500
8020387033	MTG 6,4 (31-40)	31-40	500
8020387034	MTG 6,4 (41-50)	41+50	500
8020387035	MTG 6,4 (51-60)	51-60	500
8020387036	MTG 6,4 (61-70)	61-70	500
8020387037	MTG 6,4 (71-80)	71-80	500
8020387038	MTG 6,4 (81-90)	81-90	500
8020387040	MTG 6,4 (91-100)	91-100	500
8020387029	MTG 6,4 (0-9)	0-9	500
8020387039	MTG 6,4 (1-50)	1-50	500
8020387049	MTG 6,4 (51-100)	51-100	500
8020387059	MTG 6,4 (101-150)	101-150	500
8020387069	MTG 6,4 (151-200)	151-200	500
8020387079	MTG 6,4 (201-250)	201-250	500
8020387089	MTG 6,4 (251-300)	251-300	500
8020387099	MTG 6,4 (301-350)	301-350	500
8020387109	MTG 6,4 (351-400)	351-400	500
8020387119	MTG 6,4 (401-450)	401-450	500
8020387129	MTG 6,4 (451-500)	451-500	500
8020387139	MTG 6,4 (501-550)	501-550	500
8020387149	MTG 6,4 (551-600)	551-600	500
8020387159	MTG 6,4 (601-650)	601-650	500
8020387169	MTG 6,4 (651-700)	651-700	500
8020387179	MTG 6,4 (701-750)	701-750	500
8020387189	MTG 6,4 (751-800)	751-800	500
8020387199	MTG 6,4 (801-850)	801-850	500
8020387209	MTG 6,4 (851-900)	851-900	500
8020387219	MTG 6,4 (901-950)	901-950	500
8020387229	MTG 6,4 (951-1000)	951-1000	500
8020387239	MTG 6,4 (1001-1050)	1001-1050	500
8020387249	MTG 6,4 (1051-1100)	1051-1100	500

Klemens Etiketleri

Marking Tags

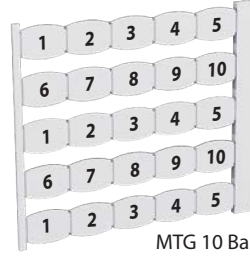

MTG 10 Baskılı



MTG 10 Baskısız

Ürün Kodu Product Code	Ürün Adı Product Name	Açıklama Description	Amb. Mik. Pack. Qty (Etiket - Tags / Pcs.)
8020386019	MTG 8 Baskılı	Baskılı / Printed	500
8020386009	MTG 8 Baskısız	Boş / Empty	500
8020386199	MTG 8 (0)	0	500
8020386209	MTG 8 (1)	1	500
8020386219	MTG 8 (2)	2	500
8020386229	MTG 8 (3)	3	500
8020386239	MTG 8 (4)	4	500
8020386249	MTG 8 (5)	5	500
8020386259	MTG 8 (6)	6	500
8020386269	MTG 8 (7)	7	500
8020386279	MTG 8 (8)	8	500
8020386289	MTG 8 (9)	9	500
8020386299	MTG 8 (10)	10	500
8020386309	MTG 8 (0-9)	0-9	500
8020386319	MTG 8 (1-10)	1-10	500
8020386029	MTG 8 (1-50)	1-50	500
8020386039	MTG 8 (51-100)	51-100	500
8020386049	MTG 8 (101-150)	101-150	500
8020386059	MTG 8 (151-200)	151-200	500
8020386069	MTG 8 (201-250)	201-250	500
8020386079	MTG 8 (251-300)	251-300	500
8020386089	MTG 8 (301-350)	301-350	500
8020386099	MTG 8 (351-400)	351-400	500
8020386109	MTG 8 (401-450)	401-450	500
8020386119	MTG 8 (451-500)	451-500	500
8020386169	MTG 8 (701-750)	701-750	500
8020386189	MTG 8 (801-850)	801-850	500
8020386329	MTG 8 (+)	+	500
8020386339	MTG 8 (-)	-	500
8020386349	MTG 8 (PE)	PE	500
8020386359	MTG 8 (L)	L	500
8020386369	MTG 8 (N)	N	500
8020386379	MTG 8 (L1, L2, L3)	L1, L2, L3	500
8020386389	MTG 8 (L1)	L1	500
8020386399	MTG 8 (L2)	L2	500
8020386409	MTG 8 (L3)	L3	500
8020385019	MTG 10 Baskılı	Baskılı / Printed	250
8020385009	MTG 10 Baskısız	Boş / Empty	250
8020385029	MTG 10 (1)	1	250
8020385039	MTG 10 (2)	2	250
8020385049	MTG 10 (3)	3	250
8020385059	MTG 10 (4)	4	250
8020385069	MTG 10 (5)	5	250
8020385079	MTG 10 (6)	6	250
8020385089	MTG 10 (7)	7	250
8020385099	MTG 10 (8)	8	250
8020385109	MTG 10 (9)	9	250
8020385119	MTG 10 (10)	10	250
8020385129	MTG 10 (RSTN)	RSTN	250
8020385139	MTG 10 (L1)	L1	250
8020385149	MTG 10 (L2)	L2	250
8020385159	MTG 10 (L3)	L3	250

Montaj Rayları

Mounting Rails

Elektrolitik beyaz krom kaplanmış galvaniz çelik malzeme
Electrolytic white chromated & galvanized steel material
EN 50022 EN 50035 IEC 60715

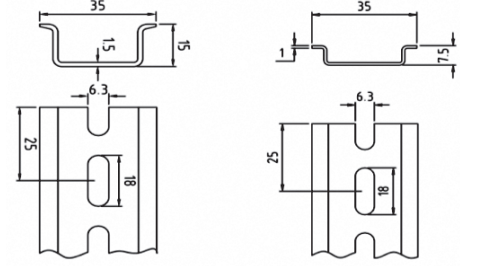

Ürün Kodu Product Code	Ürün Adı Product Name	Ölçüler / Dimensions (mm)			Açıklama Explanation	Birim Uzunluk Unit Length (m)	Ambalaj Miktarı Packing Qty (metre/meter)
		W	H	D			
8015393407	DR 35-7,5 S 2M	35	7,5	1	Delikli Din Normu Ray / Slotted Din Rail	2	40
8015393427	DR 35-15 S 2M	35	15	1,5	Delikli Din Normu Ray / Slotted Din Rail	2	20

Eko Seri Montaj Rayları

Economical Range Mounting Rails

Ürün Kodu Product Code	Ürün Adı Product Name	Ölçüler / Dimensions (mm)			Açıklama Explanation	Birim Uzunluk Unit Length (m)	Ambalaj Miktarı Packing Qty (metre/meter)
		W	H	D			
8015393447	DR 35-7,5 E 2M	35	7,5	0,9	Delikli Ray / Slotted Rail	2	50

Ray Taşıyıcılar

Rail Supports

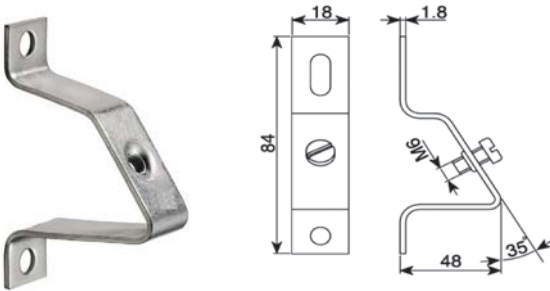

Ürün Kodu Product Code	Ürün Adı Product Name	Açıklama Explanation	Delik Çapı Dia. Hole	Ambalaj Miktarı Packing Qty (Adet/pcs.)
8015393507	ART - M6	35° Açılı Ray Taşıyıcı 35° Angeled Rail Support	M6	50

Ray Kapağı

Rail Cover



Ürün Kodu Product Code	Ürün Adı Product Name	Açıklama Explanation	Ambalaj Miktarı Packing Qty (Adet/pcs.)
8015393537	C-DR 7,5	Ray Kenar Kapağı Rail Cover	200
8015393547	C-DR 15		100

Kanal Kesme Makası

Wiring Duct Cutter



WDC 125

Ürün Kodu Product Code	Ürün Adı Product Name	Açıklama Explanation	Ambalaj Miktarı Packing Qty (Adet/pcs.)
8019391300	WDC 125	125 mm genişliğe kadar kablo kanalları için Düz kesim tezgah üstü makas. Flat-cut Table-top type cutter up to 120 mm duct width	1

Ray Kesme Makası

Din Rail Cutters



DRC 2W8R



DRC 1W

Ürün Kodu Product Code	Ürün Adı Product Name	Açıklama Explanation	Ambalaj Miktarı Packing Qty (Adet/pcs.)
8015393557	DRC 1W	35x7.5 raya uygun, 1.5 mm kalınlığa kadar kesim, 1 gözlü tezgah üstü makas. 1 way table-top type cutter for 35x7.5 Din Rail, up to 1.5 mm thickness	1
8015393567	DRC 2W8R	35x7.5, 35x15 raya ve 8 mm Tij kesimine uygun, 3 gözlü tezgah üstü makas. 3 way table-top type cutter for 35x7.5, 35x15 Din Rails and 8 mm Rod	1

Distribution Blocks Dağıtım Blokları



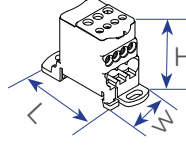

SDB 80 A

YENİ
NEW



Ürün Adı / Product Name	SDB 80 A		
Sipariş No / Order No.	8037000100		
Paket Adeti / Packing Qty.	1		
Ebatlar / Size (LxWxH) (mm)	66x27x46		
Vida / Screw	Çinko Kaplı Çelik / Zinc-Coated Steel		
İletkenler / Conductor	Kalay Kaplı Pirinç / Tin-Coated Brass		
Gövde / Housing	PA		
Kapak / Cover	PC		
Anma Değerleri / Rated Values	1000 V / 80 A		
IEC 60947-7-1	3		
Kısa süreli dayanım akımı / Short-time withstand current I_{cw}(kA)	22		
Kısa süreli dayanım akımı en yüksek değeri / The peak current value during the short-time withstand current testing I_{pk}(kA)	22		
Bağlantı Bilgileri / Connection Information	A Giriş Input	B Çıkış Output	C Çıkış Output
Bağlantı Noktası / Connection Points	x1	x4	x2
Tork / Torque (Nm)	3,5	1,2	3,5
Çap / Diameter (mm)	6,8	4,5	6,8
Metrik Kablo / Metric Wire mm²	6~16	2,5~6	2,5~16
AWG	16~4	16~8	16~4

SDB 125 A**YENİ
NEW****SDB 125 A**

8037000110

1

77x29x46

Çinko Kaplı Çelik / Zinc-Coated Steel**Kalay Kaplı Pirinç / Tin-Coated Brass**

PA

PC

1000 V / 125 A

4,2

30

A Giriş Input	B Çıkış Output	C Çıkış Output
x1	x1	x6
8,5	3,5	3,5
10	6,8	6,8
10 ~35	6 ~16	2,5~6
8~1/10	14~2	14~4

SDB 160 A**YENİ
NEW****SDB 160 A**

8037000120

1

77x29x46

Çinko Kaplı Çelik / Zinc-Coated Steel**Kalay Kaplı Pirinç / Tin-Coated Brass**

PA

PC

1000 V / 160 A

11,8

30

A Giriş Input	B Çıkış Output	C Çıkış Output
x1	x1	x6
8,5	3,5	3,5
12,3	6,8	6,8
10 ~70	6 ~16	2,5~6
8~3/0	14~2	14~4

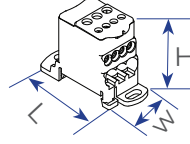

SDB 250 A

YENİ
NEW



Ürün Adı / Product Name

SDB 250A

Sipariş No / Order No.

8037000130

Paket Adeti / Packing Qty.

1

Ebatlar / Size (LxWxH) (mm)

96x46x50

Vida / Screw

Çinko Kaplı Çelik / Zinc-Coated Steel

İletkenler / Conductor

Kalay Kaplı Pirinç / Tin-Coated Brass

Gövde / Housing

PA

Kapak / Cover

PC

Anma Değerleri / Rated Values

IEC 60947-7-1

1000 V / 250 A

Kısa süreli dayanım akımı / Short-time withstand current I_{cw}(KA)

24,5

Kısa süreli dayanım akımı en yüksek değeri / The peak current value during the short-time withstand current testing I_{pk}(KA)

51

Bağlantı Bilgileri / Connection Information

Bağlantı Noktası / Connection Points

Tork / Torque (Nm)

Çap / Diameter (mm)

Metrik Kablo / Metric Wire mm²

AWG

A Giriş Input	B Çıkış Output	C Çıkış Output	D Çıkış Output
x1	x2	x4	x5
19	4,4	2,7	2,7
15	9	6,1	6,8
35 ~ 120	6 ~ 35	2.5 ~ 10	2.5 ~ 16
16 ~ 250 kcmil	10 ~ 1	14 ~ 6	14 ~ 4

SDB 400 A**YENİ
NEW****SDB 400 A**

8037000140

1

96x46x50

Çinko Kaplı Çelik / Zinc-Coated Steel**Kalay Kaplı Pirinç / Tin-Coated Brass**

PA

PC

1000 V / 400 A

24,5

51

A Giriş Input	B Çıkış Output	C Çıkış Output	D Çıkış Output
x1	x2	x4	x5
25	4,4	2,7	2,7
19	9	6,1	6,8
3/0~400 kcmil	6 ~ 35	2.5 ~ 10	2.5 ~ 16
8 ~ 1/10	10 ~ 1	14 ~ 6	14 ~ 4

SDB 500 A**YENİ
NEW****SDB 500 A**

8037000150

1

96x46x50

Çinko Kaplı Çelik / Zinc-Coated Steel**Kalay Kaplı Pirinç / Tin-Coated Brass**

PA

PC

1000 V / 500 A

24,5

51

A Giriş Input	B Çıkış Output	C Çıkış Output	D Çıkış Output
x1	x2	x4	x5
13,5	4,4	2,7	2,7
--	9	6,1	6,8
--	6 ~ 35	2.5 ~ 10	2.5 ~ 16
--	10 ~ 1	14 ~ 6	14 ~ 4

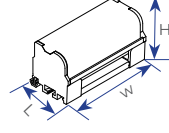

Ürün Adı / Product Name

TDB 2 x 7-100A

Sipariş No / Order No.

8037000220

Paket Adeti / Packing Qty.

1

Ebatlar / Size (LxWxH) (mm)

50x64x50

Vida / Screw

Çinko Kaplı Çelik / Zinc-Coated Steel

İletkenler / Conductor

Pirinç / Brass

Gövde / Housing

PA

Kapak / Cover

PC

Anma Değerleri / Rated Values

IEC 60947-7-1

500 V / 100 A

Kısa süreli dayanım akımı / Short-time withstand current I_{cw}(KA)

4,5

Kısa süreli dayanım akımı en yüksek değeri / The peak current value during the short-time withstand current testing I_{pk}(KA)

20

Bağlantı Bilgileri / Connection Information

Bağlantı Noktası / Connection Points

Tork / Torque (Nm)

Çap / Diameter (mm)

Tek Damarlı Kablo / Solid Conductor Cross-Section mm²

Çok Damarlı Kablo / Stranded Conductor Cross-Section mm²

A Giriş Input	A Çıkış Output	B Çıkış Output
x1	x3	x3
2 ~ 3	1,2 ~ 1,5	2 ~ 3
8,5	4,5	5,5
10 ~ 25	1,5 ~ 4	2,5 ~ 6
10 ~ 25	0,75 ~ 4	1,5 ~ 6

TDB 2 x 7 - 125 A**YENİ
NEW****TDB 2 x 7 - 125 A**

8037000230

1

50x64x50

Çinko Kaplı Çelik / Zinc-Coated Steel**Pirinç / Brass**

PA

PC

500 V / 125 A

4,5

20

A Giriş Input	A Çıkış Output	B Çıkış Output
x1	x1	x5
2 ~ 3	2 ~ 3	2 ~ 3
8,5	7,5	5,3
10~35	10~25	2,5~6
10~25	6~16	1,5~6

TDB 2 x 8-80A**YENİ
NEW****TDB 2 x 8-80A**

8037000210

1

50x64x50

Çinko Kaplı Çelik / Zinc-Coated Steel**Pirinç / Brass**

PA

PC

500 V / 80 A

4,5

20

A Giriş Input	A Çıkış Output
x3	x5
2	1,2
5,5	4,5
2,5 ~16	1,5 ~10
1,5 ~10	0,75~6

TDB 2 x 11-100A**YENİ
NEW****TDB 2 x 11-100A**

8037000221

1

50x100x50

Çinko Kaplı Çelik / Zinc-Coated Steel**Pirinç / Brass**

PA

PC

500 V / 100 A

4,5

20

A Giriş Input	A Çıkış Output	B Çıkış Output
x2	x4	x5
2 ~ 3	1,2 ~ 1,5	2 ~ 3
8,5	4,5	5,5
10 ~ 25	1,5 ~ 4	2,5 ~ 6
10 ~ 25	0,75 ~ 4	1,5 ~ 6

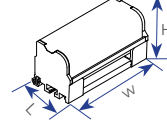

TDB 2 x 11-125A

YENİ
NEW



Ürün Adı / Product Name	TDB 2 x 11-125A		
Sipariş No / Order No.	8037000231		
Paket Adeti / Packing Qty.	1		
Ebatlar / Size (LxWxH) (mm)	50x100x50		
Vida / Screw	Çinko Kaplı Çelik / Zinc-Coated Steel		
İletkenler / Conductor	Pirinç / Brass		
Gövde / Housing	PA		
Kapak / Cover	PC		
Anma Değerleri / Rated Values			
IEC 60947-7-1	500 V / 125 A		
Kısa süreli dayanım akımı / Short-time withstand current I_{cw}(KA)	4,5		
Kısa süreli dayanım akımı en yüksek değeri / The peak current value during the short-time withstand current testing I_{Pk}(KA)	20		
Bağlantı Bilgileri / Connection Information	A Giriş Input	A Çıkış Output	B Çıkış Output
Bağlantı Noktası / Connection Points	x2	x2	x7
Tork / Torque (Nm)	2 ~ 3	2 ~ 3	2 ~ 3
Çap / Diameter (mm)	8,5	7,5	5,3
Tek Damarlı Kablo / Solid Conductor Cross-Section mm²	10~35	10~25	2,5~6
Çok Damarlı Kablo / Stranded Conductor Cross-Section mm²	10~25	6~16	1,5~6

TDB 2 x 15-125A**YENİ
NEW****TDB 2 x 15-125A**

8037000232

1

50x130x50

Çinko Kaplı Çelik / Zinc-Coated Steel**Pirinç / Brass**

PA

PC

500 V / 125 A

4,5

20

A Giriş Input	A Çıkış Output	B Çıkış Output
x2	x2	x11
2 ~ 3	2 ~ 3	2 ~ 3
8,5	7,5	5,3
10~35	10~25	2,5~6
10~25	6~16	1,5~6

TDB 2 x 18-80A**YENİ
NEW****TDB 2 x 18-80A**

8037000211

1

50x130x50

Çinko Kaplı Çelik / Zinc-Coated Steel**Pirinç / Brass**

PA

PC

500 V / 80 A

4,5

20

A Giriş Input	A Çıkış Output
x6	x12
2	1,2
5,5	4,5
2,5 ~16	1,5 ~10
1,5~10	0,75~6

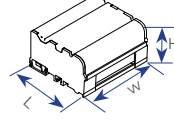

Ürün Adı / Product Name	FDB 4 x 7-100A		
Sipariş No / Order No.	8037000320		
Paket Adeti / Packing Qty.	1		
Ebatlar / Size (LxWxH) (mm)	90x64x50		
Vida / Screw	Çinko Kaplı Çelik / Zinc-Coated Steel		
İletkenler / Conductor	Pirinç / Brass		
Gövde / Housing	PA		
Kapak / Cover	PC		
Anma Değerleri / Rated Values			
IEC 60947-7-1	500 V / 100 A		
Kısa süreli dayanım akımı / Short-time withstand current I_{cw}(KA)	4,5		
Kısa süreli dayanım akımı en yüksek değeri / The peak current value during the short-time withstand current testing I_{pk}(KA)	20		
Bağlantı Bilgileri / Connection Information	A Giriş Input	A Çıkış Output	B Çıkış Output
Bağlantı Noktası / Connection Points	x1	x3	x3
Tork / Torque (Nm)	2 ~ 3	1,2 ~ 1,5	2 ~ 3
Çap / Diameter (mm)	8,5	4,5	5,5
Tek Damarlı Kablo / Solid Conductor Cross-Section mm²	10 ~ 25	1,5 ~ 4	2,5 ~ 6
Çok Damarlı Kablo / Stranded Conductor Cross-Section mm²	10 ~ 25	0,75 ~ 4	1,5 ~ 6

FDB 4 x 7-125AYENİ
NEW**FDB 4 x 7-125A**

8037000330

1

90x64x50

Çinko Kaplı Çelik / Zinc-Coated Steel**Pirinç / Brass**

PA

PC

500 V / 125 A

4,5

20

A Giriş Input	A Çıkış Output	B Çıkış Output
x1	x1	x5
2 ~ 3	2 ~ 3	2 ~ 3
8,5	7,5	5,3
10 ~ 35	10 ~ 25	2,5 ~ 6
10 ~ 25	6 ~ 16	1,5 ~ 6

FDB 4 x 8-80AYENİ
NEW**FDB 4 x 8-80A**

8037000310

1

90x64x50

Çinko Kaplı Çelik / Zinc-Coated Steel**Pirinç / Brass**

PA

PC

500 V / 80 A

4,5

20

A Giriş Input	A Çıkış Output
x3	x5
2	1,2
5,5	4,5
2,5 ~ 16	1,5 ~ 10
1,5 ~ 10	0,75 ~ 6

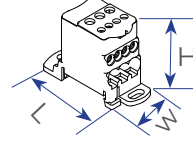

Ürün Adı / Product Name	FDB 4 x 11-100A		
Sipariş No / Order No.	8037000321		
Paket Adeti / Packing Qty.	1		
Ebatlar / Size (LxWxH) (mm)	90x100x50		
Vida / Screw	Çinko Kaplı Çelik / Zinc-Coated Steel		
İletkenler / Conductor	Pirinç / Brass		
Gövde / Housing	PA		
Kapak / Cover	PC		
Anma Değerleri / Rated Values	500 V / 100 A		
Kısa süreli dayanım akımı / Short-time withstand current I_{cw}(KA)	4,5		
Kısa süreli dayanım akımı en yüksek değeri / The peak current value during the short-time withstand current testing I_{pk}(KA)	20		
Bağlantı Bilgileri / Connection Information	A Giriş Input	A Çıkış Output	B Çıkış Output
Bağlantı Noktası / Connection Points	x2	x4	x5
Tork / Torque (Nm)	2 ~ 3	1,2 ~ 1,5	2 ~ 3
Çap / Diameter (mm)	8,5	4,5	5,5
Tek Damarlı Kablo / Solid Conductor Cross-Section mm²	10 ~ 25	1,5 ~ 4	2,5 ~ 6
Çok Damarlı Kablo / Stranded Conductor Cross-Section mm²	10 ~ 25	0,75 ~ 4	1,5 ~ 6

FDB 4 x 11-125A**YENİ
NEW****FDB 4 x 11-125A**

8037000331

1

90x100x50

Çinko Kaplı Çelik / Zinc-Coated Steel**Pirinç / Brass**

PA

PC

500 V / 125 A

4,5

20

A Giriş Input	A Çıkış Output	B Çıkış Output
x2	x2	x7
2 ~ 3	2 ~ 3	2 ~ 3
8,5	7,5	5,3
10 ~ 35	10 ~ 25	2,5 ~ 6
10 ~ 25	6 ~ 16	1,5 ~ 6

FDB 4 x 15-125A**YENİ
NEW****FDB 4 x 15-125A**

8037000332

1

90x130x50

Çinko Kaplı Çelik / Zinc-Coated Steel**Pirinç / Brass**

PA

PC

500 V / 125 A

4,5

20

A Giriş Input	A Çıkış Output	B Çıkış Output
x2	x2	x11
2 ~ 3	2 ~ 3	2 ~ 3
8,5	7,5	5,3
10 ~ 35	10 ~ 25	2,5 ~ 6
10 ~ 25	6 ~ 16	1,5 ~ 6

FDB 4 x 18-80A**YENİ
NEW****FDB 4 x 18-80A**

8037000312

1

90x130x50

Çinko Kaplı Çelik / Zinc-Coated Steel**Pirinç / Brass**

PA

PC

500 V / 80 A

4,5

20

A Giriş Input	A Çıkış Output
x6	x12
2	1,2
5,5	4,5
2,5 ~ 16	1,5 ~ 10
1,5 ~ 10	0,75 ~ 6

Pano Tipi Delikli Kablo Kanalları

Panel Type Slotted Wiring Ducts

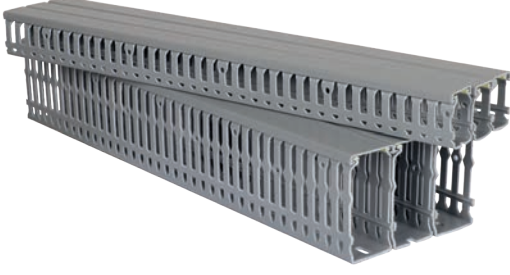

Kendini söndürebilen sert PVC malzeme

Self-extinguishing rigid PVC material

EN 50085-1+A

EN 50085-2-3

IEC 60695-2-11



Ürün Kodu Product Code	Ürün Adı Product Name	Ölçüler / Dimensions (mm)		Renk Color	Ambalaj Miktarı Packing Qty (metre/meter)
		W	H		
8019391008	SWD 25x40 Pano Tipi Kablo Kanalı / Panel Type Slotted Wiring Ducts	25	40	Gri / Gray	60
8019391018	SWD 25x60 Pano Tipi Kablo Kanalı / Panel Type Slotted Wiring Ducts	25	60	Gri / Gray	40
8019391318	SWD 25x80 Pano Tipi Kablo Kanalı / Panel Type Slotted Wiring Ducts	25	80	Gri / Gray	20
8019391028	SWD 40x40 Pano Tipi Kablo Kanalı / Panel Type Slotted Wiring Ducts	40	40	Gri / Gray	40
8019391038	SWD 40x60 Pano Tipi Kablo Kanalı / Panel Type Slotted Wiring Ducts	40	60	Gri / Gray	36
8019391048	SWD 40x80 Pano Tipi Kablo Kanalı / Panel Type Slotted Wiring Ducts	40	80	Gri / Gray	28
8019391058	SWD 60x40 Pano Tipi Kablo Kanalı / Panel Type Slotted Wiring Ducts	60	40	Gri / Gray	32
8019391068	SWD 60x60 Pano Tipi Kablo Kanalı / Panel Type Slotted Wiring Ducts	60	60	Gri / Gray	24
8019391078	SWD 60x80 Pano Tipi Kablo Kanalı / Panel Type Slotted Wiring Ducts	60	80	Gri / Gray	16
8019391088	SWD 80x60 Pano Tipi Kablo Kanalı / Panel Type Slotted Wiring Ducts	80	60	Gri / Gray	20
8019391098	SWD 80x80 Pano Tipi Kablo Kanalı / Panel Type Slotted Wiring Ducts	80	80	Gri / Gray	16
8019391108	SWD 80x100 Pano Tipi Kablo Kanalı / Panel Type Slotted Wiring Ducts	80	100	Gri / Gray	8
8019391118	SWD 100x60 Pano Tipi Kablo Kanalı / Panel Type Slotted Wiring Ducts	100	60	Gri / Gray	12
8019391128	SWD 100x80 Pano Tipi Kablo Kanalı / Panel Type Slotted Wiring Ducts	100	80	Gri / Gray	8
8019391138	SWD 100x100 Pano Tipi Kablo Kanalı / Panel Type Slotted Wiring Ducts	100	100	Gri / Gray	8

Kablo Kanal Kapakları

Wiring Duct Covers

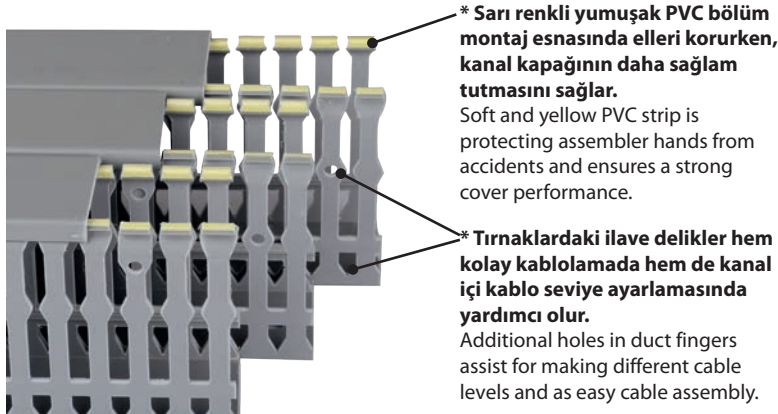

Ürün Kodu Product Code	Ürün Adı Product Name	En Width (mm.)	Boy Length (m.)	Renk Color	Ambalaj Miktarı Packing Qty (metre/meter)
8019391208	SWC 25 Kapak / Wiring Duct Covers	20	2	Gri / Gray	40
8019391218	SWC 40 Kapak / Wiring Duct Covers	40	2	Gri / Gray	40
8019391228	SWC 60 Kapak / Wiring Duct Covers	60	2	Gri / Gray	40
8019391238	SWC 80 Kapak / Wiring Duct Covers	80	2	Gri / Gray	20
8019391248	SWC 100 Kapak / Wiring Duct Covers	100	2	Gri / Gray	20

LAZER YAZICI

LASER PRINTER

Ribbon, mürekkep kullanımı yok.

Ömür boyu silinmez markalama

1 saniyede 10 karakteri markalar

Uzun süreli kullanım için Endüstriyel ve Dayanıklı Tasarım

Metal ve plastik markalama için tek platform

20W fiber lazer

EN 60825-1 uyumluluk

No need for ribbon and/or ink.

Everlasting Printing

Prints 10 letter characters/sec

Industrial and robust design for long run usage

Single platform for plastic and metal marking

20W fiber laser

Compliance with EN 60825-1



PROLASE EKOSİSTEMİ

PROLASE ECOSYSTEM

Yeni **lazer yazıcı ekosistemimiz**, endüstriyel etiketleme süreçlerinde standartları yeniden tanımlıyor. **Prolase yazılımı** sayesinde Eplan, WSCAD programlarında oluşturduğunuz markalama verilerini doğrudan aktarabilir ve markalamaya hatasız bir şekilde başlayabilirsiniz. Sarf malzemeye ihtiyaç duymadan, lazer teknolojisinin sunduğu **hız, dayanıklılık ve mükemmel hassasiyetle** etiketlerinizi kalıcı hale getirin. Artık baskı değil, **lazer keskinliğinde mükemmellik zamanı**.

Our new **laser printer ecosystem** is redefining standards in industrial labeling processes. With **Prolase software**, you can easily design label templates, prepare your data, and send it to the laser printer with a single click. Thanks to **Prolase software**, you can directly import the marking data you created in Eplan or WSCAD and start marking without human error. It's no longer about printing — it's about **laser-sharp perfection**.

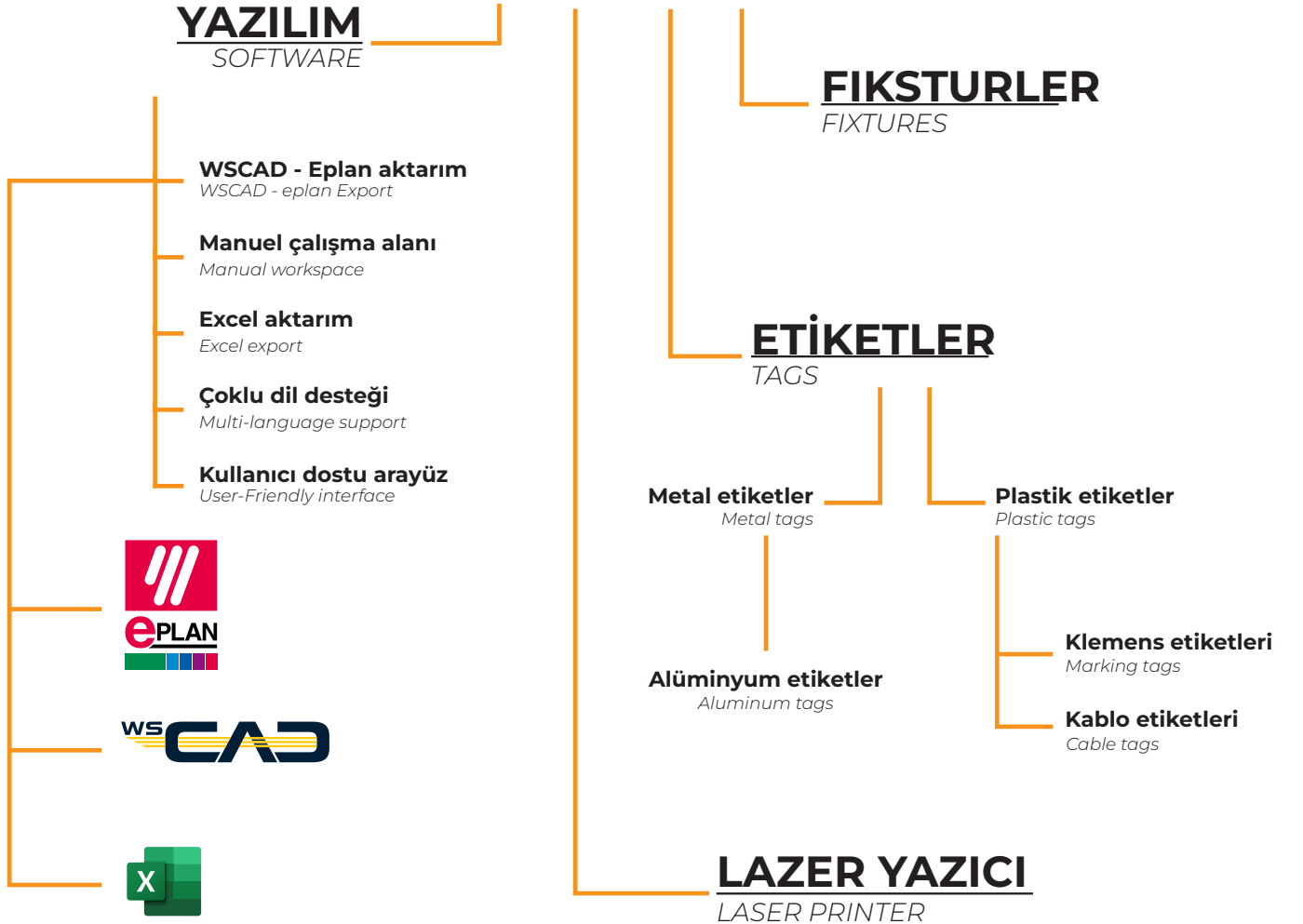
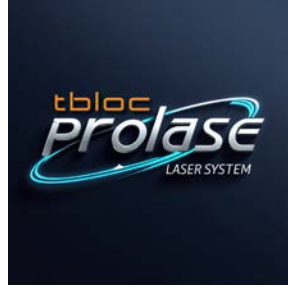

LAZER YAZICI
LASER PRINTER

Ürün Kodu Product Code	Ürün Adı Product Name	Amb. Mik. Pack. Qty. (Ad./Pcs.)
8030121000	PROLASE LAZER YAZICI / PROLASE LASER PRINTER	1



PAKET İÇERİĞİ
INCLUDED IN THE PACKAGE

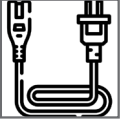

Güç Kablosu
Power Cable

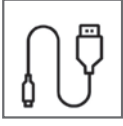

Data Kablosu
Data Cable



Lens Pompası
Lens Pump



Latex Eldiven
Latex Gloves



Şişe
Bottle

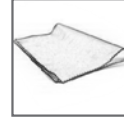

Temizlik Bezi
Cleaning Cloth



Lisans USB
Licence USB

AKSESUARLAR
ACCESSORIES

VAKUM TEMİZLEME CİHAZLARI / VACUUM CLEANING DEVICES

Ürün Kodu Product Code	Ürün Adı Product Name	Amb. Mik. Pack. Qty. (Ad./Pcs.)
8030122001	RENFERT SILENT VAKUM TEMİZLEYİCİ / RENFERT SILENT VACUUM	1
8030122002	SN-FAN SET SALYANGOZ FAN VAKUM TEMİZLEYİCİ / SN-FAN SET SNAIL FAN VACUUM CLEANER	1



FİKSTÜRLER / FIXTURES

Ürün Kodu Product Code	Ürün Adı Product Name	Amb. Mik. Pack. Qty. (Ad./Pcs.)
8030130010	FIXT LTG-O LAZER YAZICI FIKSTÜRÜ / FIXT LTG-O LASER PRINT FIXTURE	1
8030130020	FIXT LTG-5,2 LAZER YAZICI FIKSTÜRÜ / FIXT LTG-5.2 LASER PRINT FIXTURE	1
8030130030	FIXT LTG-N LAZER YAZICI FIKSTÜRÜ / FIXT LTG-N LASER PRINT FIXTURE	1
8030130040	FIXT ALTG-GEN LAZER YAZICI FIKSTÜRÜ / FIXT LTG-GEN LASER PRINT FIXTURE	1
8030130050	FIXT ALTG-1 LAZER YAZICI FIKSTÜRÜ / FIXT LTG-1 LASER PRINT FIXTURE	1
8030130060	FIXT ICTG LAZER YAZICI FIKSTÜRÜ / FIXT ICTG LASER PRINTER FIXTURE	1
8030130070	FIXT TCTG LAZER YAZICI FIKSTÜRÜ / FIXT TCTG LASER PRINTER FIXTURE	1
8030130080	FIXT SCTG LAZER YAZICI FIKSTÜRÜ / FIXT SCTG LASER PRINTER FIXTURE	1

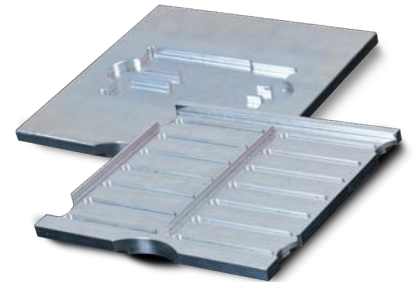

KLEMENS ETİKETLERİ
MARKING TAGS

LAZER KLEMENS ETİKETLERİ / LASER MARKING TAGS

Ürün Kodu Product Code	Ürün Adı Product Name	Uyumlu Markalar Compatible Brands	Açıklama Explanation	Ebatlar Size(mm)	Amb. Mik. Pack. Qty. (Ad./Pcs.)
8020370009	LTG 5X6 BOŞ / LTG 5X6 BLANK	TBLOC, Weidmueller, Klemsan, Onka	BOŞ BLANK Klemens Etiketi Marking Tag	5x6	500
8020371009	LTG 6X6 BOŞ / LTG 6X6 BLANK	TBLOC, Weidmueller, Klemsan, Onka		6x6	500
8020372009	LTG 6,4X6 BOŞ / LTG 6,4X6 BLANK	TBLOC, Weidmueller, Klemsan, Onka		6,4x6	500
8020373009	LTG 8X7 BOŞ / LTG 8X7 BLANK	TBLOC, Weidmueller, Klemsan, Onka		8x7	500
8020374009	LTG 10X7 BOŞ / LTG 10X7 BLANK	TBLOC, Weidmueller, Klemsan, Onka		10x7	250
8020375009	LTG 5.2X10 BOŞ / LTG 5,2X10 BLANK	TBLOC, Weidmueller, Klemsan, Onka		5,2x10	700
8020370019	LTG 5X6 BASKILI / LTG 5X6 PRINTED	TBLOC, Weidmueller, Klemsan, Onka	BASKILI PRINTED Klemens Etiketi Marking Tag	5x6	500
8020371019	LTG 6X6 BASKILI / LTG 6X6 PRINTED	TBLOC, Weidmueller, Klemsan, Onka		6x6	500
8020372019	LTG 6,4X6 BASKILI / LTG 6,4X6 PRINTED	TBLOC, Weidmueller, Klemsan, Onka		6,4x6	500
8020373019	LTG 8X7 BASKILI / LTG 8X7 PRINTED	TBLOC, Weidmueller, Klemsan, Onka		8x7	500
8020374019	LTG 10X7 BASKILI / LTG 10X7 PRINTED	TBLOC, Weidmueller, Klemsan, Onka		10x7	250
8020375019	LTG 5.2X10 BASKILI / LTG 5,2X10 PRINTED	TBLOC, Weidmueller, Klemsan, Onka		5,2x10	700
8020375109	LTG 5X10 PC BOŞ / LTG 5X10 PC BLANK	Phoenix Contact	Klemens Etiketi Marking Tags	5x10	1.000
8020375119	LTG 5X10 PC BASKILI / LTG 5X10 PC PRINTED	Phoenix Contact		5x10	1.000

UYUMLU FİKSTÜR / COMPATIBLE FIXTURE



LTG 5.2X10

PFT 2,5 PUSH-IN VE NTB 2,5 VİDALI KLEMENSLERİMİZ İLE UYUMLUDUR.
COMPATIBLE WITH OUR PFT 2.5 PUSH-IN AND NTB 2.5 SCREW TERMINAL BLOCKS.



Ürün Adı Product Name	LTG 5.2X10	LTG 5X6	LTG 6X6	LTG 6,4X6	LTG 8X7	LTG 10X7
Kullanıldığı Klemens Used with	NTB 2,5, PFT 2,5	NTB 2,5, PFT 2,5	NTB 4, PFT 4, TBL 2,5	TBL 4	NTB 6, PFT 6, TBL 6	NTB 10, PFT 10, TBL 10



UYUMLU FİKSTÜR / COMPATIBLE FIXTURE

8030130010 | **Fixt Ltg-o Lazer Yazıcı Fikstürü**
Fixt Ltg-o Laser Print Fixture

8030130020 | **Fixt Ltg-5,2 Lazer Yazıcı Fikstürü**
Fixt Ltg-5.2 Laser Print Fixture

KABLO ETİKETLERİ
CABLE TAGS

ŞEFFAF TÜP KABLO ETİKETLERİ / TUBE ENTRY CABLE MARKING TAGS

Ürün Kodu Product Code	Ürün Adı Product Name	Açıklama Explanation	Amb. Mik. Pack. Qty. (Ad./Pcs.)
8021307009	TCTG 12X4 W	Tüp İçi Kablo Etiketi Tube Entry Cable Marking Tag	600
8021307109	TCTG 15x4 W		800
8021307209	TCTG 18X4 W		600
8021307309	TCTG 23X4 W		600

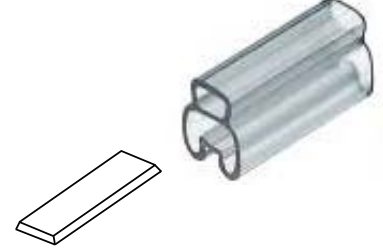

ŞEFFAF TÜPLER / TRANSPARENT SLEEVES - CLOSED / INSERTION TYPE

Ürün Kodu Product Code	Ürün Adı Product Name	Açıklama Explanation	Renk Color	Amb. Mik. Pack. Qty. (Ad./Pcs.)
8021357009	LTS 12 0,35-1,0	Bu tabloda listelenen şeffaf tüpler, sadece TCTG serisi ürünlerle uyumluluk göstermektedir. <i>The transparent tubes listed in this table are compatible only with TCTG series products.</i>	Şeffaf Transparent	3.000
8021357019	LTS 12 1,0-2,5			3.000
8021357029	LTS 12 2,5-6,0			1.000
8021357039	LTS 12 6,0-25			500
8021357049	LTS 15 0,35-1,0			3.000
8021357059	LTS 15 1,0-2,5			3.000
8021357069	LTS 15 2,5-6,0			1.000
8021357079	LTS 15 6,0-25			500
8021357089	LTS 18 0,35-1,0			3000
8021357099	LTS 18 1,0-2,5			3000
8021357109	LTS 18 2,5-6,0			1000
8021357119	LTS 18 6,0-25			500
8021357129	LTS 23 0,35-1,0			3000
8021357139	LTS 23 1,0-2,5			3000
8021357149	LTS 23 2,5-6,0			1000
8021357159	LTS 23 6,0-25			500



UYUMLU FİKSÜR
COMPATIBLE FIXTURE

8030130070 | TCTG Tüp İçi Kablo Etiketi için Fiksür
Fixture for TCTG Tube Entry Cable Markers

KABLO ETİKETLERİ
CABLE TAGS

GEÇİŞLİ KABLO ETİKETLERİ / INLET CABLE MARKING TAGS

Ürün Kodu Product Code	Ürün Adı Product Name	Açıklama Explanation	Amb. Mik. Pack. Qty. (Ad./Pcs.)
8021308009	ICTG 1 12 W (0,5-1,5 MM2)	Geçişli Kablo Etiketi <i>Inlet Cable Marking Tag</i>	600
8021308109	ICTG 1 16 W (0,5-1,5 MM2)		600
8021309009	ICTG 2 12 W (1,0-6,0 MM2)		600
8021309109	ICTG 2 16 W (1,0-6,0 MM2)		600

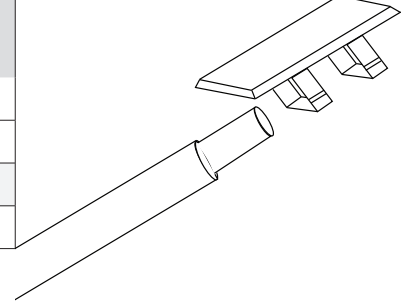

**Kablo etiketin alt kısmının
içinden geçirilerek montaja hazırlanır.**

*Cable should pass through the bottom side of
the marking tag before assembly.*



UYUMLU FIKSTÜR / COMPATIBLE FIXTURE

8030130060 | ICTG Geçişli Kablo Etiketi için Fikstür
Fixture for ICTG Inlet Cable Markers

Prolase ekosistemi hakkında daha fazla bilgi almak için YouTube kanalımızı ziyaret edin.

Visit our YouTube channel to learn more about the Prolase ecosystem.



YouTube

ALÜMİNYUM ETİKETLER
ALUMINUM TAGS

ALÜMİNYUM YÜZEY ETİKETLERİ / ALUMINUM TAGS

Ürün Kodu Product Code	Ürün Adı Product Name	Açıklama Explanation	Renk Color	Amb. Mik. Pack. Qty. (Ad./Pcs.)
8022710000	ALTG 60X30	Eloksal anodize kaplamalı 5005 kalite alüminyum <i>5005 grade aluminium with anodized coating</i>	Siyah / Black	10
8022710010	ALTG 35X18			10
8022710020	ALTG 120X120			10
8022710030	ALTG 120X100			10
8022710040	ALTG 120X80			10
8022710050	ALTG 100X100			10
8022710060	ALTG 100X80			10
8022710070	ALTG 100X60			10
8022710080	ALTG 80X80			10
8022710090	ALTG 80X60			10

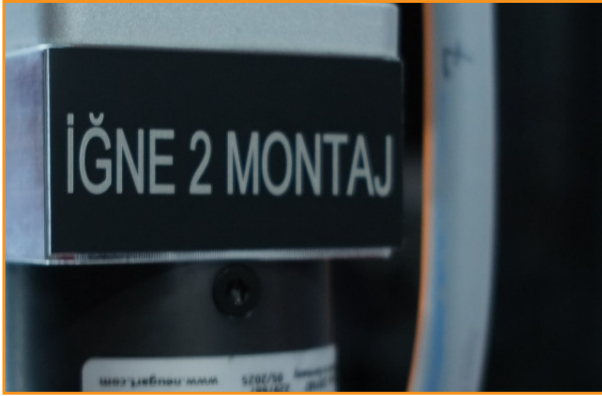

ALTG 60X30



UYUMLU FİKSTÜR / COMPATIBLE FIXTURE

8030130040 Fixt Altg-gen Lazer Yazıcı Fikstürü
Fixt Ltg-gen Laser Print Fixture

8030130050 Fixt Altg-1 Lazer Yazıcı Fikstürü
Fixt Ltg-1 Laser Print Fixture

Etiket şablonları arasında seçim yapma

Choosing between label templates

Kullanıcılar için dil seçeneği

Language options for users



Excel den etiket şablonuna aktarma

Exporting from Excel to label template.

Proje sayfaları arasında geçiş yapma

Switches between project pages



Eplan -Wscad-Excel arasında geçiş yapma

Switch between Eplan-Wscad-Excel

Ezcad'e aktarma

Export to Ezcad

Yazıcı kontrol butonları

Printer control buttons

Markalama Sistemleri

Marking Systems



Termal Transfer Yazıcı

Thermal Transfer Printer



Ürün Kodu Product Code	Ürün Adı Product Name	Amb. Mik. Pack. Qty. (Ad./Pcs.)
8030129000	TBL TP2 Termal Yazıcı / Thermal Printer	1

Ribonlar

Ribbons



Ürün Kodu Product Code	Ürün Adı Product Name	İç Çap Inner Diameter (mm)	Ölçüler Dimensions (mmxm)	Renk Color	Amb. Mik. Pack. Qty. (Ad./Pcs.)
8030129120	RR Ribbon 50x300	25,4 (1 inch)	50x300	Siyah / Black	1
8030129130	RR Ribbon 110x300	25,4 (1 inch)	110x300	Siyah / Black	1

Klemensler için Şerit Etiket

Terminal Blocks Strip Label

Ürün Kodu Product Code	Ürün Adı Product Name	Ölçüler Dimensions (mmxm)	Renk Color	Rulo Etiket Labels Roll	Amb. Mik. Pack. Qty. (Ad./Pcs.)
8020384009	TBSL 22x20	22x20	Beyaz White	2 sıra Şerit Etiket 2 pcs. of Strip Label	1
8020384009	TBSL 22x20 (Sarı - Beyaz / Yellow - white)	22x20	Sarı Yellow	2 sıra Şerit Etiket 2 pcs. of Strip Label	1
8020384011	TBSL 5,15x5	25,75x20	Beyaz White	5 sıra Şerit Etiket 5 pcs. of Strip Label	1



TBSL 22x20



TBSL 22x20
(Sarı - Beyaz / Yellow - white)

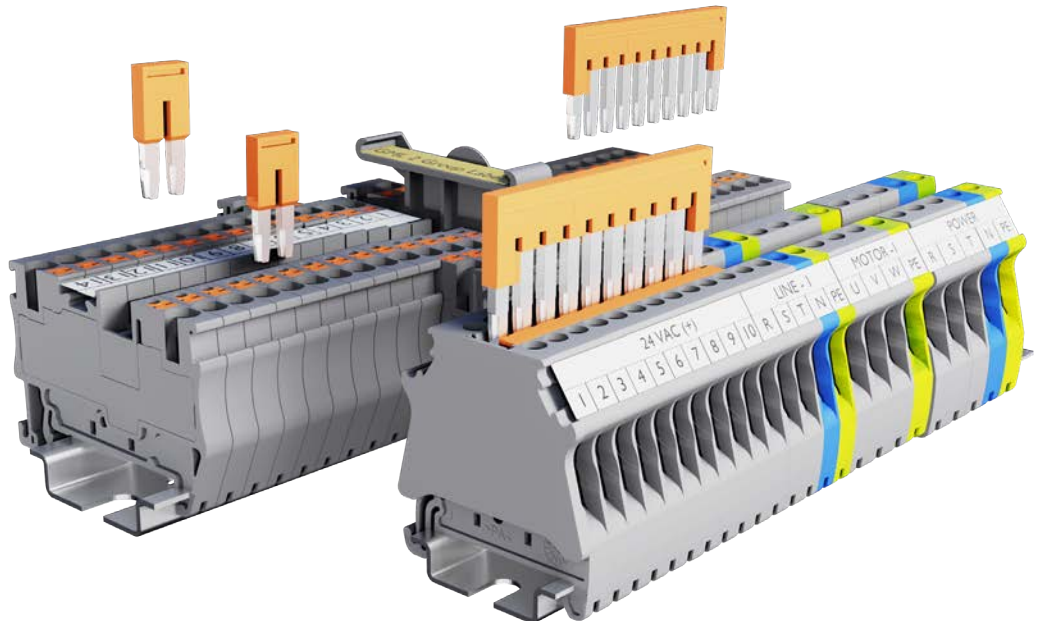

Kablo İşaretleme Plakaları (Şeffaf Tüpler için)

Cable Marking Plates (for Transparent Sleeves)

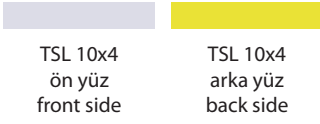

Ürün Kodu Product Code	Ürün Adı Product Name	Yazım Alanı Print Area (mm)	Açıklama Explanation	Amb. Mik. Pack. Qty. (Ad./Pcs.)
8021340004	TSL 10x4 Sarı - Beyaz / Yellow - White	10 x 4	Katlamalı Folded	3.000
8021340104	TSL 12x4 Sarı - Beyaz / Yellow - White	12 x 4	Katlamalı Folded	3.000
8021340014	TSL 15x4 Sarı - Beyaz / Yellow - White	15 x 4	Katlamalı Folded	3.000
8021340024	TSL 20x4 Sarı - Beyaz / Yellow - White	20 x 4	Katlamalı Folded	3.000
8021340034	TSL 30x4 Sarı - Beyaz / Yellow - White	30 x 4	Katlamalı Folded	3.000

Şeffaf Tüpler

Transparent Sleeves - Closed / Insertion Type



TS 10 1,5-2,5



TS 10 2,5-4,0



TS 10 6,0-10



TS 10 16-25

Ürün Kodu Product Code	Ürün Adı Product Name	Uzunluk Length (mm)	Renk Color	İletken Kesit Cond. Cross Sec. (mm ²)	Amb. Mik. Pack. Qty. (Ad./Pcs.)
8021343019	TS 10 1,5-2,5	10	Şeffaf / Transparent	1,5 - 2,5	500
8021343029	TS 12 1,5-2,5	12	Şeffaf / Transparent	1,5 - 2,5	500
8021343039	TS 15 1,5-2,5	15	Şeffaf / Transparent	1,5 - 2,5	500
8021343049	TS 20 1,5-2,5	20	Şeffaf / Transparent	1,5 - 2,5	500
8021343059	TS 30 1,5-2,5	30	Şeffaf / Transparent	1,5 - 2,5	500
8021344019	TS 10 2,5-4,0	10	Şeffaf / Transparent	2,5 - 4	500
8021344029	TS 12 2,5-4,0	12	Şeffaf / Transparent	2,5 - 4	500
8021344039	TS 15 2,5-4,0	15	Şeffaf / Transparent	2,5 - 4	500
8021344049	TS 20 2,5-4,0	20	Şeffaf / Transparent	2,5 - 4	500
8021344059	TS 30 2,5-4,0	30	Şeffaf / Transparent	2,5 - 4	500
8021345019	TS 10 6,0-10	10	Şeffaf / Transparent	6 - 10	500
8021345029	TS 12 6,0-10	12	Şeffaf / Transparent	6 - 10	500
8021345039	TS 15 6,0-10	15	Şeffaf / Transparent	6 - 10	500
8021345049	TS 20 6,0-10	20	Şeffaf / Transparent	6 - 10	500
8021345059	TS 30 6,0-10	30	Şeffaf / Transparent	6 - 10	500
8021346019	TS 10 16-25	10	Şeffaf / Transparent	16 - 25	500
8021346029	TS 12 16-25	12	Şeffaf / Transparent	16 - 25	500
8021346039	TS 15 16-25	15	Şeffaf / Transparent	16 - 25	500
8021346049	TS 20 16-25	20	Şeffaf / Transparent	16 - 25	200
8021346059	TS 30 16-25	30	Şeffaf / Transparent	16 - 25	200

İnce Yapışkanlı Etiketler (Pano Yüzeyi, Kontaktör ve Pano İçi Diğer Cihazlar için)

Slim Adhesive Labels (For Panel Surface, Contactors and Other Devices Inside Panel)



SPEL 27x15



SPEL 35x15



SPEL 15x6

Ürün Kodu Product Code	Ürün Adı Product Name	Yazım Alanı Print Area (mm)	Renk Color	Amb. Mik. Pack. Qty. (Ad./Pcs.)
8022120004	SPEL 12x9	12x9	Sarı / Yellow	2.500
8022120008	SPEL 12x9	12x9	Gümüş / Silver	2.500
8022120009	SPEL 12x9	12x9	Beyaz / White	2.500
8022120014	SPEL 15x6	15x6	Sarı / Yellow	2.500
8022120018	SPEL 15x6	15x6	Gümüş / Silver	2.500
8022120019	SPEL 15x6	15x6	Beyaz / White	2.500
8022120024	SPEL 15x9	15x9	Sarı / Yellow	2.500
8022120028	SPEL 15x9	15x9	Gümüş / Silver	2.500
8022120029	SPEL 15x9	15x9	Beyaz / White	2.500
8022120034	SPEL 17x10	17x10	Sarı / Yellow	2.500
8022120038	SPEL 17x10	17x10	Gümüş / Silver	2.500
8022120039	SPEL 17x10	17x10	Beyaz / White	2.500
8022120044	SPEL 18x8	18x8	Sarı / Yellow	2.500
8022120048	SPEL 18x8	18x8	Gümüş / Silver	2.500
8022120049	SPEL 18x8	18x8	Beyaz / White	2.500
8022120054	SPEL 27x12,5	27x12	Sarı / Yellow	2.500
8022120058	SPEL 27x12,5	27x12	Gümüş / Silver	2.500
8022120059	SPEL 27x12,5	27x12	Beyaz / White	2.500
8022120064	SPEL 27x15	27x15	Sarı / Yellow	2.500
8022120068	SPEL 27x15	27x15	Gümüş / Silver	2.500
8022120069	SPEL 27x15	27x15	Beyaz / White	2.500
8022120074	SPEL 27x18	27x18	Sarı / Yellow	2.500
8022120078	SPEL 27x18	27x18	Gümüş / Silver	2.500
8022120079	SPEL 27x18	27x18	Beyaz / White	2.500
8022120098	SPEL 35x18	35x18	Gümüş / Silver	1.500
8022120108	SPEL 45x15	45x15	Gümüş / Silver	2.000
8022120118	SPEL 70x30	70x30	Gümüş / Silver	250
8022120128	SPEL 90x40	90x40	Gümüş / Silver	250
8022120138	SPEL 100x50	100x50	Gümüş / Silver	250



Kalın Yapışkanlı Etiketler (Pano Yüzeyi için)

Thick Adhesive Labels (For Panel Surface)



TPEL 40x30

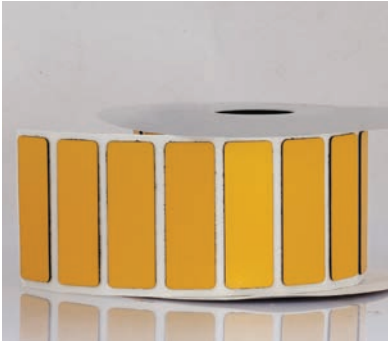

TPEL 60x15



TPEL 45x15

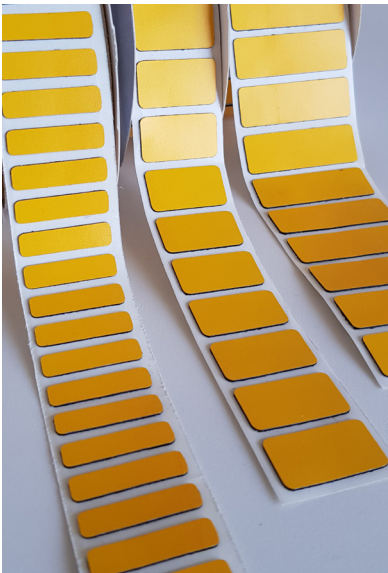

Ürün Kodu Product Code	Ürün Adı Product Name	Yazım Alanı Print Area (mm)	Renk Color	Amb. Mik. Pack. Qty. (Ad./Pcs.)
8022130014	TPEL 22x22	22x22	Sarı / Yellow	150
8022130018	TPEL 22x22	22x22	Gümüş / Silver	150
8022130019	TPEL 22x22	22x22	Beyaz / White	150
8022130004	TPEL 27x12,5	27x12	Sarı / Yellow	150
8022130008	TPEL 27x12,5	27x12	Gümüş / Silver	150
8022130009	TPEL 27x12,5	27x12	Beyaz / White	150
8022130024	TPEL 27x15	27x15	Sarı / Yellow	150
8022130028	TPEL 27x15	27x15	Gümüş / Silver	150
8022130029	TPEL 27x15	27x15	Beyaz / White	150
8022130109	TPEL 27x18	27x18	Sarı / Yellow	150
8022130108	TPEL 27x18	27x18	Gümüş / Silver	150
8022130104	TPEL 27x18	27x18	Beyaz / White	150
8022130034	TPEL 27x27	27x27	Sarı / Yellow	150
8022130038	TPEL 27x27	27x27	Gümüş / Silver	150
8022130039	TPEL 27x27	27x27	Beyaz / White	150
8022130044	TPEL 35x18	35x18	Sarı / Yellow	150
8022130048	TPEL 35x18	35x18	Gümüş / Silver	150
8022130049	TPEL 35x18	35x18	Beyaz / White	150
8022130054	TPEL 40x30	40x30	Sarı / Yellow	125
8022130058	TPEL 40x30	40x30	Gümüş / Silver	125
8022130059	TPEL 40x30	40x30	Beyaz / White	125
8022130064	TPEL 45x15	45x15	Sarı / Yellow	150
8022130068	TPEL 45x15	45x15	Gümüş / Silver	150
8022130069	TPEL 45x15	45x15	Beyaz / White	150
8022130074	TPEL 60x15	60x15	Sarı / Yellow	150
8022130078	TPEL 60x15	60x15	Gümüş / Silver	150
8022130079	TPEL 60x15	60x15	Beyaz / White	150
8022130084	TPEL 60x30	60x30	Sarı / Yellow	125
8022130088	TPEL 60x30	60x30	Gümüş / Silver	125
8022130089	TPEL 60x30	60x30	Beyaz / White	125
8022130094	TPEL 90x45	90x45	Sarı / Yellow	50
8022130098	TPEL 90x45	90x45	Gümüş / Silver	50
8022130099	TPEL 90x45	90x45	Beyaz / White	50



Buton Etiketleri (22 mm Çapa Uygun)

Push Button Labels (Suitable for 22 mm Diameter)



TPBL 30x40



Ürün Kodu Product Code	Ürün Adı Product Name	Yazım Alanı Print Area (mm)	Renk Color	Delik Çapı Hole Dia. (mm)	Amb. Mik. Pack. Qty. (Ad./Pcs.)
8022130114	TPBL 30x40	30 x 13	Sarı / Yellow	23,5	100
8022130118	TPBL 30x40	30 x 13	Gümüş / Silver	23,5	100
8022130119	TPBL 30x40	30 x 13	Beyaz / White	23,5	100



TPBL 30x40

Buton Etiket Tutucular (22 mm Çapa Uygun)

Push Button Labels (Suitable for 22 mm Diameter)



TBET 50x30

TBET 40x30

Ürün Kodu Product Code	Ürün Adı Product Name	Yazım Alanı Print Area (mm)	Renk Color	Amb. Mik. Pack. Qty. (Ad./Pcs.)
8022130330	TBET 40x30	25 x 8	Siyah / Black	60
8022130340	TBET 50x30	25 x 18	Siyah / Black	60

Buton Etiket Tutucular (22 mm Çapa Uygun)

Push Button Labels (Suitable for 22 mm Diameter)

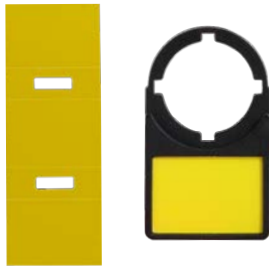

Ürün Kodu Product Code	Ürün Adı Product Name	Yazım Alanı Print Area (mm)	Renk Color	Amb. Mik. Pack. Qty. (Ad./Pcs.)
8022130214	TPBL 27x18	27 x 18	Sarı / Beyaz Yellow / White	1000

Yapışkanlı Pano Etiket Tutucular

Self Adhesive Panel Labels Holders



TYPET 17x75



TYPET 17x50



TYPET 17x30

Ürün Kodu Product Code	Ürün Adı Product Name	Yazım Alanı Print Area (mm)	Renk Color	Amb. Mik. Pack. Qty. (Ad./Pcs.)
8022130300	TYPET 17x30	27 x 14	Siyah / Black	100
8022130310	TYPET 17x50	49 x 15	Siyah / Black	50
8022130320	TYPET 17x75	72 x 15	Siyah / Black	25

Boş yazım kağıtları paketin içersindedir.
Empty printing papers are inside the package

Klemens Grup Etiketleri için Etiketler

Labels for Terminal Blocks Group Markers

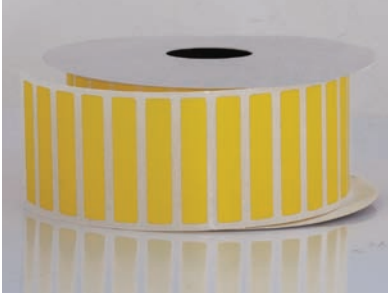

GML 2 36x7

Ürün Kodu Product Code	Ürün Adı Product Name	Yazım Alanı Print Area (mm)	Renk Color	Uyumlu Ürün Explanation	Amb. Mik. Pack. Qty. (Ad./Pcs.)
8022130124	GML 1 36x17	36 x 17	Sarı / Yellow	GM 1	2.000
8022130134	GML 2 36x7	36 x 7	Sarı / Yellow	GM 2	2.000



Yapışkanlı Bant Etiketler

Self Adhesive Endless Labels



SALT 5x20

Ürün Kodu Product Code	Ürün Adı Product Name	Ölçüler Dimensions (mxm)	Renk Color	Amb. Mik. Pack. Qty. (Ad./Pcs.)
8022130144	SALT 5x20	5 x 20	Sarı / Yellow	1
8022130128	SALT 5x20	5 x 20	Gümüş / Silver	1
8022130129	SALT 5x20	5 x 20	Beyaz / White	1
8022130244	SALT 2x20	2 x 20	Sarı / Yellow	1

Acil Stop Etiketleri (22mm Çapa Uygun)

Emergency Stop Labels (Suitable for 22mm Diameter)



Ürün Kodu Product Code	Ürün Adı Product Name	Etiket Çapı Label Dia. (mm)	Delik Çapı Hole Dia. (mm)	Renk Color	Amb. Mik. Pack. Qty. (Ad./Pcs.)
8022130350	ASE60	60	23,5	Sarı / Yellow	1

Kablo Bağı ile Bağlanan Etiketler (Doğrudan Kablo Bağına Takılan)

Labels Assembled with Cable Ties (Directly Assembled to Cable Ties)



RCTL 50x15

HCTL 25x10

Ürün Kodu Product Code	Ürün Adı Product Name	Yazım Alanı Print Area (mm)	Renk Color	Açıklama Explanation	Amb. Mik. Pack. Qty. (Ad./Pcs.)
8021341019	HCTL 25x10	25 x 10	Beyaz / White	Altıgen / Hexagonal	250
8021342019	RCTL 25x10	25 x 10	Beyaz / White	Dikdörtgen / Rectangular	250
8021342029	RCTL 50x15	50 x 15	Beyaz / White	Dikdörtgen / Rectangular	250
8021342039	RCTL 60x30	60 x 30	Beyaz / White	Dikdörtgen / Rectangular	250

Kablo Bağı ile Bağlanan Etiketler (Etiket Kılıfıyla Bağlananlar)

Labels Assembled with Cable Ties (Assembled with Label Holder)

Ürün Kodu Product Code	Ürün Adı Product Name	Yazım Alanı Print Area (mm)	Renk Color	Açıklama Explanation	Amb. Mik. Pack. Qty. (Ad./Pcs.)
8021334009	CM 1		Beyaz / White	Etiket Kılıfı 1 / Label Holder 1	100
8021334019	CM 2		Beyaz / White	Etiket Kılıfı 2 / Label Holder 2	100

Boş yazım kağıtları paketin içerisinde.

Empty printing papers are inside the package

Ürün Kodu Product Code	Ürün Adı Product Name	Renk Color	Ölçüler / Dimensions		
			L	W	T
8021334009	CM 1	Beyaz / White	35	10	8
8021334019	CM 2	Beyaz / White	45	20	8

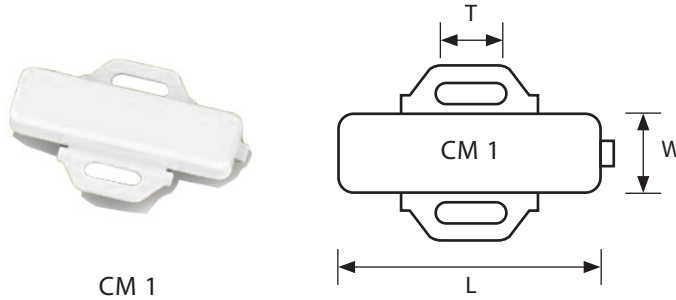

CM 1

Müşterek w otomat baraları

Pin mcb busbars

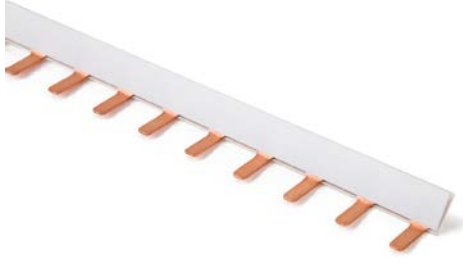

Monofaze W Otomat Baraları

Singlephase MCB Busbars

Ürün Kodu Product Code	Ürün Adı Product Name	Akım Current (A)	Bara Kalınlığı Busbar Thickness (mm)	Uzunluk Length (cm.)	Modül Sayısı Module Number	Ambalaj Mik. Pack. Qty. (TL/Ad.)
8034110010	MJAB80-1x53	80	1	53	30	50
8034110020	MJAB80-1x106	80	1	106	60	50
8034110030	MJAB100-1,5x53	100	1.5	53	30	50
8034110040	MJAB100-1,5x106	100	1.5	106	60	50

Trifaze W Otomat Baraları

Threephases MCB Busbars

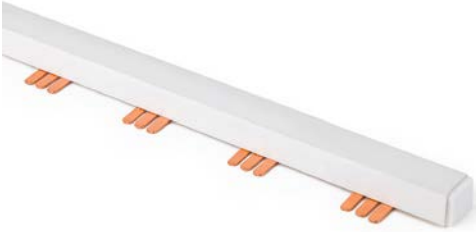

Ürün Kodu Product Code	Ürün Adı Product Name	Akım Current (A)	Bara Kalınlığı Busbar Thickness (mm)	Uzunluk Length (cm.)	Modül Sayısı Module Number	Ambalaj Mik. Pack. Qty. (TL/Ad.)
8034330010	TJAB63- 1x53	63	1	53	10	25
8034330020	TJAB63- 1x106	63	1	106	20	25
8034330030	TJAB80- 1x53	80	1	53	10	25
8034330040	TJAB80- 1x106	80	1	106	20	25
8034330050	TJAB100-1,5x53	100	1.5	53	10	25
8034330060	TJAB100-1,5x106	100	1.5	106	20	25

Ürün Kodu Product Code	Ürün Adı Product Name	Ambalaj Mik. Pack. Qty. (TL/Ad.)
8034110009	MCB Monofaze otomat barası kapagi / Singlephase mcb busbar side covers	500
8034330009	TCB Trifaze otomat barası kapagi / Threephases mcb busbar side covers	500

Paslanmaz Çelik Kablo Bağları - 304 Kalite

Stainless Steel Cable Ties - Grade 304



Ürün Kodu Product Code	Ürün Adı Product Name	Ölçüler (BoyxEn) Dimensions (LxW) (mm)	Maks. Sıkma Çapı Max. Bundle Dia. (mm)	Min. Açılma Mukavemeti Min. Loop Tensile Strenght (kg.)	Amb. Mik. Pack. Qty (Adet/Pcs.)	Koli Mik. Carton Qty. (Adet/Pcs.)
8016335010	SSCT 150x4.6	150x4.6	33	55	100	8.000
8016335020	SSCT 200x4.6	200x4.6	50	55	100	6.000
8016335030	SSCT 250x4.6	250x4.6	67	55	100	5.000
8016335040	SSCT 300x4.6	300x4.6	75	55	100	5.000
8016335050	SSCT 370x4.6	370x4.6	102	55	100	4.000
8016335060	SSCT 450x4.6	450x4.6	130	55	100	3.000
8016335070	SSCT 520x4.6	520x4.6	152	55	100	3.000
8016335080	SSCT 680x4.6	680x4.6	203	55	100	2.000
8016335090	SSCT 840x4.6	840x4.6	254	55	100	1.000
8016335100	SSCT 200x7.9	200x7.9	50	120	100	5.000
8016335110	SSCT 300x7.9	300x7.9	75	120	100	4.000
8016335120	SSCT 370x7.9	370x7.9	102	120	100	3.000
8016335130	SSCT 450x7.9	450x7.9	130	120	100	3.000
8016335140	SSCT 520x7.9	520x7.9	152	120	100	2.000
8016335150	SSCT 680x7.9	680x7.9	203	120	100	2.000
8016335160	SSCT 840x7.9	840x7.9	254	120	100	1.000
8016335170	SSCT 1000x7.9	1000x7.9	305	120	100	1.000



Teknik Özellikler

Technical Futures

Malzeme / Material	304 kalite Paslanmaz Çelik / 304 grade Stainless Steel
Su Emilimi / Water Absorption	Yok / No
Alev Yürümeme / Flame Retardant	UL94V-2
UV Dayanıklılığı / UV Resistance	Mükemmel / Excellent
Kimyasal Dayanım / Chemical Resistance	Mükemmel / Excellent
Çalışma Sıcaklığı / Operating Temperature	-80°C + 538°C

Plastik Kablo Bağları

Plastic Cable Ties

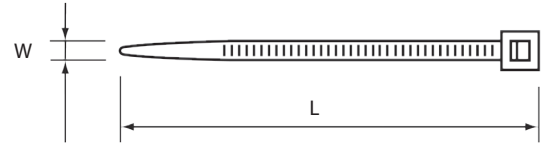

Ürün Kodu Product Code	Ürün Adı Product Name	Ölçüler (Boy x En) Dimensions (L x W) (mm)	Maks. Sıkma Çapı Max. Bundle Dia. (mm)	Min. Açılma Mukavemeti Min. Loop Tensile Strength (kg.)	Amb. Mik. Pack. Qty (Adet/Pcs.)	Koli Mik. Carton Qty. (Adet/Pcs.)
8016330109	PCT 100 x 2.5 Beyaz / White	100 x 2.5	22	8	100	26.000
8016330110	PCT 100 x 2.5 Siyah / Black	100 x 2.5	22	8	100	26.000
8016330209	PCT 150 x 2.5 Beyaz / White	150 x 2.5	35	8	100	20.000
8016330210	PCT 150 x 2.5 Siyah / Black	150 x 2.5	35	8	100	20.000
8016330309	PCT 200 x 2.5 Beyaz / White	200 x 2.5	55	8	100	18.000
8016330310	PCT 200 x 2.5 Siyah / Black	200 x 2.5	55	8	100	18.000
8016330409	PCT 140 x 3.6 Beyaz / White	140 x 3.6	36	18	100	12.000
8016330410	PCT 140 x 3.6 Siyah / Black	140 x 3.6	36	18	100	12.000
8016330509	PCT 200 x 3.6 Beyaz / White	200 x 3.6	52	18	100	10.000
8016330510	PCT 200 x 3.6 Siyah / Black	200 x 3.6	52	18	100	10.000
8016330609	PCT 250 x 3.6 Beyaz / White	250 x 3.6	68	18	100	8.000
8016330610	PCT 250 x 3.6 Siyah / Black	250 x 3.6	68	18	100	8.000
8016330709	PCT 280 x 3.6 Beyaz / White	280 x 3.6	82	18	100	8.000
8016330710	PCT 280 x 3.6 Siyah / Black	280 x 3.6	82	18	100	8.000
8016330809	PCT 370 x 3.6 Beyaz / White	370 x 3.6	105	18	100	6.000
8016330810	PCT 370 x 3.6 Siyah / Black	370 x 3.6	105	18	100	6.000
8016331009	PCT 200 x 4.8 Beyaz / White	200 x 4.8	49	22	100	7.000
8016331010	PCT 200 x 4.8 Siyah / Black	200 x 4.8	49	22	100	7.000
8016331209	PCT 250 x 4.8 Beyaz / White	250 x 4.8	68	22	100	6.000
8016331210	PCT 250 x 4.8 Siyah / Black	250 x 4.8	68	22	100	6.000
8016331309	PCT 300 x 4.8 Beyaz / White	300 x 4.8	83	22	100	5.000
8016331310	PCT 300 x 4.8 Siyah / Black	300 x 4.8	83	22	100	5.000
8016331509	PCT 370 x 4.8 Beyaz / White	370 x 4.8	105	22	100	4.000
8016331510	PCT 370 x 4.8 Siyah / Black	370 x 4.8	105	22	100	4.000
8016331709	PCT 430 x 4.8 Beyaz / White	430 x 4.8	125	22	100	3.000
8016331710	PCT 430 x 4.8 Siyah / Black	430 x 4.8	125	22	100	3.000
8016332009	PCT 300 x 7.6 Beyaz / White	300 x 7.6	80	55	100	3.000
8016332010	PCT 300 x 7.6 Siyah / Black	300 x 7.6	80	55	100	3.000
8016332209	PCT 370 x 7.6 Beyaz / White	370 x 7.6	101	55	100	2.500
8016332210	PCT 370 x 7.6 Siyah / Black	370 x 7.6	101	55	100	2.500
8016332309	PCT 450 x 7.6 Beyaz / White	450 x 7.6	128	55	100	2.500
8016332310	PCT 450 x 7.6 Siyah / Black	450 x 7.6	128	55	100	2.500
8016332329	PCT 550 x 7.6 Beyaz / White	550 x 7.6	155	55	100	1.500
8016332320	PCT 550 x 7.6 Siyah / Black	550 x 7.6	155	55	100	1.500
8016332339	PCT 750 x 7.6 Beyaz / White	750 x 7.6	220	55	100	1.200
8016332330	PCT 750 x 7.6 Siyah / Black	750 x 7.6	220	55	100	1.200
8016332409	PCT 600 x 9.0 Beyaz / White	600 x 9.0	160	80	100	1.200
8016332410	PCT 600 x 9.0 Siyah / Black	600 x 9.0	160	80	100	1.200
8016332609	PCT 760 x 9.0 Beyaz / White	760 x 9.0	227	80	100	1.200
8016332610	PCT 760 x 9.0 Siyah / Black	760 x 9.0	227	80	100	1.200
8016332709	PCT 900 x 9.0 Beyaz / White	900 x 9.0	275	80	100	1.200
8016332710	PCT 900 x 9.0 Siyah / Black	900 x 9.0	275	80	100	1.200

- Siyah renkli kablo bağları UV (Ultraviyole) ışınlarına karşı dayanıklıdır.
- Black colored cable ties are UV (Ultraviolet) resistant.

Yapışkan Kroşeler

Self Adhesive Tie Mounts

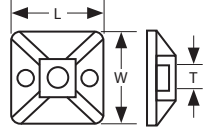

Ürün Kodu Product Code	Ürün Adı Product Name	Ölçüler Dimensions (mm)			Amb. Mik. Pack. Qty (Adet/Pcs.)
		L	W	T	
8016333009	ATM 19 x 19 Beyaz / White	19	19	3,6	100
8016333010	ATM 19 x 19 Siyah / Black	19	19	3,6	100
8016333109	ATM 28 x 28 Beyaz / White	28	28	4,8	100
8016333110	ATM 28 x 28 Siyah / Black	28	28	4,8	100

Vidalı Kroşeler

Screw Type Tie Mounts

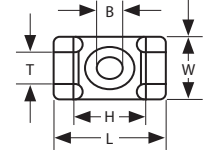

Ürün Kodu Product Code	Ürün Adı Product Name	Ölçüler Dimensions					Amb. Mik. Pack. Qty (Adet/Pcs.)
		L	W	H	T	B	
8016334009	STM 1 Beyaz / White	17,8	12,7	8,15	4,8	M3	250
8016334019	STM 2 Beyaz / White	25,4	16	10,8	9	M5	250
8016334010	STM 1 Siyah / Black	17,8	12,7	8,15	4,8	M3	250
8016334020	STM 2 Siyah / Black	25,4	16	10,8	9	M5	250

Kablo Bağı Sıkma ve Kesme Aleti

Cable Tie Tightening and Cutting Tool



Ürün Kodu Product Code	Ürün Adı Product Name	Özellik Function	Maks. Kablo Bağı Eni Max. Cable Tie Width (mm)	Amb. Mik. Pack. Qty (Adet/Pcs.)
8016334200	CTT1	Sıkma + Kesme Tightening + Cutting	4,8	1

Kablo Etiketleri

Cable Marker

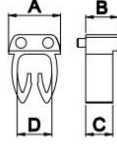

Ürün Kodu Product Code	Ürün Adı Product Name	Materyal Material	Sıcaklık Heat	Kablo Kesiti Cable Size (mm ²)	Renk Color	A	B	C	D	Amb. Mik. Pack. Qty (Adet/Pcs.)	Koli Mik. Carton Qty. (Adet/Pcs.)
8021360000	UGK 1 (0)	PA	-40 °C+140 °C	0,75 - 1,50		4.4	3	2.5	2.7	400	20000
8021360011	UGK 1 (1)	PA	-40 °C+140 °C	0,75 - 1,50		4.4	3	2.5	2.7	400	20000
8021360022	UGK 1 (2)	PA	-40 °C+140 °C	0,75 - 1,50		4.4	3	2.5	2.7	400	20000
8021360033	UGK 1 (3)	PA	-40 °C+140 °C	0,75 - 1,50		4.4	3	2.5	2.7	400	20000
8021360044	UGK 1 (4)	PA	-40 °C+140 °C	0,75 - 1,50		4.4	3	2.5	2.7	400	20000
8021360055	UGK 1 (5)	PA	-40 °C+140 °C	0,75 - 1,50		4.4	3	2.5	2.7	400	20000
8021360066	UGK 1 (6)	PA	-40 °C+140 °C	0,75 - 1,50		4.4	3	2.5	2.7	400	20000
8021360077	UGK 1 (7)	PA	-40 °C+140 °C	0,75 - 1,50		4.4	3	2.5	2.7	400	20000
8021360088	UGK 1 (8)	PA	-40 °C+140 °C	0,75 - 1,50		4.4	3	2.5	2.7	400	20000
8021360099	UGK 1 (9)	PA	-40 °C+140 °C	0,75 - 1,50		4.4	3	2.5	2.7	400	20000
8021360104	UGK 1 (+)	PA	-40 °C+140 °C	0,75 - 1,50		4.4	3	2.5	2.7	400	20000
8021360114	UGK 1 (-)	PA	-40 °C+140 °C	0,75 - 1,50		4.4	3	2.5	2.7	400	20000
8021360124	UGK 1 (±)	PA	-40 °C+140 °C	0,75 - 1,50		4.4	3	2.5	2.7	400	20000
8021360125	UGK 1 (A)	PA	-40 °C+140 °C	0,75 - 1,50		4.4	3	2.5	2.7	400	20000
8021360126	UGK 1 (B)	PA	-40 °C+140 °C	0,75 - 1,50		4.4	3	2.5	2.7	400	20000
8021360127	UGK 1 (C)	PA	-40 °C+140 °C	0,75 - 1,50		4.4	3	2.5	2.7	400	20000
8021360128	UGK 1 (D)	PA	-40 °C+140 °C	0,75 - 1,50		4.4	3	2.5	2.7	400	20000
8021360129	UGK 1 (E)	PA	-40 °C+140 °C	0,75 - 1,50		4.4	3	2.5	2.7	400	20000
8021360130	UGK 1 (F)	PA	-40 °C+140 °C	0,75 - 1,50		4.4	3	2.5	2.7	400	20000
8021360131	UGK 1 (G)	PA	-40 °C+140 °C	0,75 - 1,50		4.4	3	2.5	2.7	400	20000
8021360132	UGK 1 (H)	PA	-40 °C+140 °C	0,75 - 1,50		4.4	3	2.5	2.7	400	20000
8021360133	UGK 1 (I)	PA	-40 °C+140 °C	0,75 - 1,50		4.4	3	2.5	2.7	400	20000
8021360134	UGK 1 (J)	PA	-40 °C+140 °C	0,75 - 1,50		4.4	3	2.5	2.7	400	20000
8021360135	UGK 1 (K)	PA	-40 °C+140 °C	0,75 - 1,50		4.4	3	2.5	2.7	400	20000
8021360136	UGK 1 (L)	PA	-40 °C+140 °C	0,75 - 1,50		4.4	3	2.5	2.7	400	20000
8021360137	UGK 1 (M)	PA	-40 °C+140 °C	0,75 - 1,50		4.4	3	2.5	2.7	400	20000
8021360138	UGK 1 (N)	PA	-40 °C+140 °C	0,75 - 1,50		4.4	3	2.5	2.7	400	20000
8021360139	UGK 1 (O)	PA	-40 °C+140 °C	0,75 - 1,50		4.4	3	2.5	2.7	400	20000
8021360140	UGK 1 (P)	PA	-40 °C+140 °C	0,75 - 1,50		4.4	3	2.5	2.7	400	20000
8021360141	UGK 1 (R)	PA	-40 °C+140 °C	0,75 - 1,50		4.4	3	2.5	2.7	400	20000
8021360142	UGK 1 (S)	PA	-40 °C+140 °C	0,75 - 1,50		4.4	3	2.5	2.7	400	20000
8021360143	UGK 1 (T)	PA	-40 °C+140 °C	0,75 - 1,50		4.4	3	2.5	2.7	400	20000
8021360144	UGK 1 (U)	PA	-40 °C+140 °C	0,75 - 1,50		4.4	3	2.5	2.7	400	20000
8021360145	UGK 1 (V)	PA	-40 °C+140 °C	0,75 - 1,50		4.4	3	2.5	2.7	400	20000
8021360146	UGK 1 (W)	PA	-40 °C+140 °C	0,75 - 1,50		4.4	3	2.5	2.7	400	20000
8021360147	UGK 1 (X)	PA	-40 °C+140 °C	0,75 - 1,50		4.4	3	2.5	2.7	400	20000
8021360148	UGK 1 (Y)	PA	-40 °C+140 °C	0,75 - 1,50		4.4	3	2.5	2.7	400	20000
8021360149	UGK 1 (Z)	PA	-40 °C+140 °C	0,75 - 1,50		4.4	3	2.5	2.7	400	20000

Kablo Etiketleri

Cable Marker

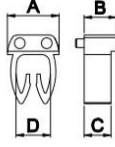

Ürün Kodu Product Code	Ürün Adı Product Name	Materyal Material	Sıcaklık Heat	Kablo Kesiti Cable Size (mm ²)	Renk Color	A	B	C	D	Amb. Mik. Pack. Qty (Adet/Pcs.)	Koli Mik. Carton Qty. (Adet/Pcs.)
8021361000	UGK 2 (0)	PA	-40 °C+140 °C	1.5 - 2.5		5	3	2.5	3.2	400	20000
8021361011	UGK 2 (1)	PA	-40 °C+140 °C	1.5 - 2.5		5	3	2.5	3.2	400	20000
8021361022	UGK 2 (2)	PA	-40 °C+140 °C	1.5 - 2.5		5	3	2.5	3.2	400	20000
8021361033	UGK 2 (3)	PA	-40 °C+140 °C	1.5 - 2.5		5	3	2.5	3.2	400	20000
8021361044	UGK 2 (4)	PA	-40 °C+140 °C	1.5 - 2.5		5	3	2.5	3.2	400	20000
8021361055	UGK 2 (5)	PA	-40 °C+140 °C	1.5 - 2.5		5	3	2.5	3.2	400	20000
8021361066	UGK 2 (6)	PA	-40 °C+140 °C	1.5 - 2.5		5	3	2.5	3.2	400	20000
8021361077	UGK 2 (7)	PA	-40 °C+140 °C	1.5 - 2.5		5	3	2.5	3.2	400	20000
8021361088	UGK 2 (8)	PA	-40 °C+140 °C	1.5 - 2.5		5	3	2.5	3.2	400	20000
8021361099	UGK 2 (9)	PA	-40 °C+140 °C	1.5 - 2.5		5	3	2.5	3.2	400	20000
8021361104	UGK 2 (+)	PA	-40 °C+140 °C	1.5 - 2.5		5	3	2.5	3.2	400	20000
8021361114	UGK 2 (-)	PA	-40 °C+140 °C	1.5 - 2.5		5	3	2.5	3.2	400	20000
8021361124	UGK 2 ($\frac{1}{2}$)	PA	-40 °C+140 °C	1.5 - 2.5		5	3	2.5	3.2	400	20000
8021361125	UGK 2 (A)	PA	-40 °C+140 °C	1.5 - 2.5		5	3	2.5	3.2	400	20000
8021361126	UGK 2 (B)	PA	-40 °C+140 °C	1.5 - 2.5		5	3	2.5	3.2	400	20000
8021361127	UGK 2 (C)	PA	-40 °C+140 °C	1.5 - 2.5		5	3	2.5	3.2	400	20000
8021361128	UGK 2 (D)	PA	-40 °C+140 °C	1.5 - 2.5		5	3	2.5	3.2	400	20000
8021361129	UGK 2 (E)	PA	-40 °C+140 °C	1.5 - 2.5		5	3	2.5	3.2	400	20000
8021361130	UGK 2 (F)	PA	-40 °C+140 °C	1.5 - 2.5		5	3	2.5	3.2	400	20000
8021361131	UGK 2 (G)	PA	-40 °C+140 °C	1.5 - 2.5		5	3	2.5	3.2	400	20000
8021361132	UGK 2 (H)	PA	-40 °C+140 °C	1.5 - 2.5		5	3	2.5	3.2	400	20000
8021361133	UGK 2 (I)	PA	-40 °C+140 °C	1.5 - 2.5		5	3	2.5	3.2	400	20000
8021361134	UGK 2 (J)	PA	-40 °C+140 °C	1.5 - 2.5		5	3	2.5	3.2	400	20000
8021361135	UGK 2 (K)	PA	-40 °C+140 °C	1.5 - 2.5		5	3	2.5	3.2	400	20000
8021361136	UGK 2 (L)	PA	-40 °C+140 °C	1.5 - 2.5		5	3	2.5	3.2	400	20000
8021361137	UGK 2 (M)	PA	-40 °C+140 °C	1.5 - 2.5		5	3	2.5	3.2	400	20000
8021361138	UGK 2 (N)	PA	-40 °C+140 °C	1.5 - 2.5		5	3	2.5	3.2	400	20000
8021361139	UGK 2 (O)	PA	-40 °C+140 °C	1.5 - 2.5		5	3	2.5	3.2	400	20000
8021361140	UGK 2 (P)	PA	-40 °C+140 °C	1.5 - 2.5		5	3	2.5	3.2	400	20000
8021361141	UGK 2 (R)	PA	-40 °C+140 °C	1.5 - 2.5		5	3	2.5	3.2	400	20000
8021361142	UGK 2 (S)	PA	-40 °C+140 °C	1.5 - 2.5		5	3	2.5	3.2	400	20000
8021361143	UGK 2 (T)	PA	-40 °C+140 °C	1.5 - 2.5		5	3	2.5	3.2	400	20000
8021361144	UGK 2 (U)	PA	-40 °C+140 °C	1.5 - 2.5		5	3	2.5	3.2	400	20000
8021361145	UGK 2 (V)	PA	-40 °C+140 °C	1.5 - 2.5		5	3	2.5	3.2	400	20000
8021361146	UGK 2 (W)	PA	-40 °C+140 °C	1.5 - 2.5		5	3	2.5	3.2	400	20000
8021361147	UGK 2 (X)	PA	-40 °C+140 °C	1.5 - 2.5		5	3	2.5	3.2	400	20000
8021361148	UGK 2 (Y)	PA	-40 °C+140 °C	1.5 - 2.5		5	3	2.5	3.2	400	20000
8021361149	UGK 2 (Z)	PA	-40 °C+140 °C	1.5 - 2.5		5	3	2.5	3.2	400	20000

Kablo Etiketleri

Cable Marker

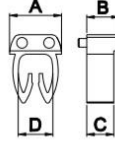

Ürün Kodu Product Code	Ürün Adı Product Name	Materyal Material	Sıcaklık Heat	Kablo Kesiti Cable Size (mm ²)	Renk Color	A	B	C	D	Amb. Mik. Pack. Qty (Adet/Pcs.)	Koli Mik. Carton Qty. (Adet/Pcs.)
8021362000	UGK 3 (0)	PA	-40 °C+140 °C	4,0 - 6,0		7.4	3	2.5	4.9	400	20000
8021362011	UGK 3 (1)	PA	-40 °C+140 °C	4,0 - 6,0		7.4	3	2.5	4.9	400	20000
8021362022	UGK 3 (2)	PA	-40 °C+140 °C	4,0 - 6,0		7.4	3	2.5	4.9	400	20000
8021362033	UGK 3 (3)	PA	-40 °C+140 °C	4,0 - 6,0		7.4	3	2.5	4.9	400	20000
8021362044	UGK 3 (4)	PA	-40 °C+140 °C	4,0 - 6,0		7.4	3	2.5	4.9	400	20000
8021362055	UGK 3 (5)	PA	-40 °C+140 °C	4,0 - 6,0		7.4	3	2.5	4.9	400	20000
8021362066	UGK 3 (6)	PA	-40 °C+140 °C	4,0 - 6,0		7.4	3	2.5	4.9	400	20000
8021362077	UGK 3 (7)	PA	-40 °C+140 °C	4,0 - 6,0		7.4	3	2.5	4.9	400	20000
8021362088	UGK 3 (8)	PA	-40 °C+140 °C	4,0 - 6,0		7.4	3	2.5	4.9	400	20000
8021362099	UGK 3 (9)	PA	-40 °C+140 °C	4,0 - 6,0		7.4	3	2.5	4.9	400	20000
8021362104	UGK 3 (+)	PA	-40 °C+140 °C	4,0 - 6,0		7.4	3	2.5	4.9	400	20000
8021362114	UGK 3 (-)	PA	-40 °C+140 °C	4,0 - 6,0		7.4	3	2.5	4.9	400	20000
8021362124	UGK 3 ($\frac{1}{2}$)	PA	-40 °C+140 °C	4,0 - 6,0		7.4	3	2.5	4.9	400	20000
8021362125	UGK 3 (A)	PA	-40 °C+140 °C	4,0 - 6,0		7.4	3	2.5	4.9	400	20000
8021362126	UGK 3 (B)	PA	-40 °C+140 °C	4,0 - 6,0		7.4	3	2.5	4.9	400	20000
8021362127	UGK 3 (C)	PA	-40 °C+140 °C	4,0 - 6,0		7.4	3	2.5	4.9	400	20000
8021362128	UGK 3 (D)	PA	-40 °C+140 °C	4,0 - 6,0		7.4	3	2.5	4.9	400	20000
8021362129	UGK 3 (E)	PA	-40 °C+140 °C	4,0 - 6,0		7.4	3	2.5	4.9	400	20000
8021362130	UGK 3 (F)	PA	-40 °C+140 °C	4,0 - 6,0		7.4	3	2.5	4.9	400	20000
8021362131	UGK 3 (G)	PA	-40 °C+140 °C	4,0 - 6,0		7.4	3	2.5	4.9	400	20000
8021362132	UGK 3 (H)	PA	-40 °C+140 °C	4,0 - 6,0		7.4	3	2.5	4.9	400	20000
8021362133	UGK 3 (I)	PA	-40 °C+140 °C	4,0 - 6,0		7.4	3	2.5	4.9	400	20000
8021362134	UGK 3 (J)	PA	-40 °C+140 °C	4,0 - 6,0		7.4	3	2.5	4.9	400	20000
8021362135	UGK 3 (K)	PA	-40 °C+140 °C	4,0 - 6,0		7.4	3	2.5	4.9	400	20000
8021362136	UGK 3 (L)	PA	-40 °C+140 °C	4,0 - 6,0		7.4	3	2.5	4.9	400	20000
8021362137	UGK 3 (M)	PA	-40 °C+140 °C	4,0 - 6,0		7.4	3	2.5	4.9	400	20000
8021362138	UGK 3 (N)	PA	-40 °C+140 °C	4,0 - 6,0		7.4	3	2.5	4.9	400	20000
8021362139	UGK 3 (O)	PA	-40 °C+140 °C	4,0 - 6,0		7.4	3	2.5	4.9	400	20000
8021362140	UGK 3 (P)	PA	-40 °C+140 °C	4,0 - 6,0		7.4	3	2.5	4.9	400	20000
8021362141	UGK 3 (R)	PA	-40 °C+140 °C	4,0 - 6,0		7.4	3	2.5	4.9	400	20000
8021362142	UGK 3 (S)	PA	-40 °C+140 °C	4,0 - 6,0		7.4	3	2.5	4.9	400	20000
8021362143	UGK 3 (T)	PA	-40 °C+140 °C	4,0 - 6,0		7.4	3	2.5	4.9	400	20000
8021362144	UGK 3 (U)	PA	-40 °C+140 °C	4,0 - 6,0		7.4	3	2.5	4.9	400	20000
8021362145	UGK 3 (V)	PA	-40 °C+140 °C	4,0 - 6,0		7.4	3	2.5	4.9	400	20000
8021362146	UGK 3 (W)	PA	-40 °C+140 °C	4,0 - 6,0		7.4	3	2.5	4.9	400	20000
8021362147	UGK 3 (X)	PA	-40 °C+140 °C	4,0 - 6,0		7.4	3	2.5	4.9	400	20000
8021362148	UGK 3 (Y)	PA	-40 °C+140 °C	4,0 - 6,0		7.4	3	2.5	4.9	400	20000
8021362149	UGK 3 (Z)	PA	-40 °C+140 °C	4,0 - 6,0		7.4	3	2.5	4.9	400	20000

Sıkmalı Kablo Pabuçları - Standart Seri

Standart Range Compression Cable Lugs - Standard Line

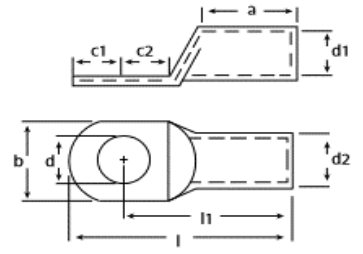

Ürün Kodu Product Code	Ürün Adı Product Name	Kesit Cross Sec. (mm ²)	Ölçüler / Dimensions (mm)									Delik Çapı Hole Dia.	Amb. Mik. Pack. Qty. (Adet/Pcs.)
			d	d1	d2	l	l1	a	b	c1	c2		
8029320610	CCL 10mm² M6	10	6,5	4,4	6	27,5	21,7	10	10,4	6	6	M6	500
8029320620	CCL 10mm² M8	10	8,5	4,4	6	27,5	21,7	10	13,7	6	6	M8	500
8029320630	CCL 16mm² M6	16	6,5	5,5	8	32,6	24,9	12	11,4	7	8	M6	300
8029320640	CCL 16mm² M8	16	8,5	5,5	8	32,6	24,9	12	13,9	7	8	M8	300
8029320641	CCL 16mm ² M10	16	10,5	5,5	8	32,6	24,9	12	16,1	7	8	M10	300
8029320649	CCL 25mm ² M6	25	6,5	7	9	39	32,3	16	13,6	6,8	9,2	M6	200
8029320650	CCL 25mm² M8	25	8,5	7	9	39	32,3	16	13,7	6,8	9,2	M8	200
8029320651	CCL 25mm ² M10	25	10,5	7	9,5	42	34,1	16	16,1	6,8	11	M10	200
8029320659	CCL 35mm ² M6	35	6,5	8,5	11	44	35,6	19	15,9	8,3	9,7	M6	150
8029320660	CCL 35mm² M8	35	8,5	8,5	11	44	35,6	19	15,9	8,3	9,7	M8	150
8029320661	CCL 35mm ² M10	35	10,5	8,5	11	48	37,9	19	15,8	10	12	M10	150
8029320669	CCL 50mm ² M8	50	8,5	10	12	47,5	39,3	21	17,8	8,3	9,7	M8	100
8029320670	CCL 50mm² M10	50	10,5	10	12	51,5	41,6	21	17,9	10	12	M10	100
8029320671	CCL 50mm ² M12	50	13	10	13	51,5	41,6	21	19,2	10	12	M12	100
8029320672	CCL 50mm ² M14	50	15	10	13	56,5	44,6	21	20,7	12	15	M14	100
8029320679	CCL 70mm ² M8	70	8,5	11,5	14,5	54,6	44,5	23	21,2	10	12	M8	75
8029320680	CCL 70mm² M10	70	10,5	11,5	14,5	54,6	44,5	23	21,2	10	12	M10	75
8029320681	CCL 70mm ² M12	70	13	11,5	14,5	54,6	44,5	23	21,3	10	12	M12	75
8029320682	CCL 70mm ² M14	70	15	11,5	14,5	62,6	47,5	23	21,5	15	15	M14	75
8029320689	CCL 95mm ² M8	95	8,5	13,5	17	58,8	48,9	26	24,7	10	12	M8	50
8029320690	CCL 95mm² M10	95	10,5	13,5	17	58,8	48,9	26	24,7	10	12	M10	50
8029320700	CCL 95mm² M12	95	13	13,5	17	58,8	48,9	26	24,6	10	12	M12	50
8029320709	CCL 120mm ² M10	120	10,5	15,5	19	69	55,9	29	28,1	13	14,5	M10	40
8029320710	CCL 120mm² M12	120	13	15,5	19	69	55,9	29	28,2	13	14,5	M12	40
8029320711	CCL 120mm ² M16	120	17	15,5	19	69	55,9	29	28,2	13	14,5	M16	40
8029320719	CCL 150mm ² M10	150	10,5	16,5	16,5	76,5	59,9	30	30,2	16,5	16,5	M10	30
8029320720	CCL 150mm² M12	150	13	16,5	21	76,5	59,9	30	30,1	16,5	16,5	M12	30
8029320721	CCL 150mm ² M16	150	17	16,5	21	76,5	59,9	30	30,1	16,5	16,5	M16	30
8029320729	CCL 185mm ² M12	185	13	18,5	23	82,5	65,6	33	34,2	17	18	M12	25
8029320730	CCL 185mm² M16	185	17	18,5	23	82,5	65,6	33	34,1	17	18	M16	25
8029320739	CCL 240mm ² M12	240	13	21	26	89	72,1	38	38,2	17	18	M12	20
8029320740	CCL 240mm² M16	240	17	21	26	89	72,1	38	38,2	17	18	M16	20



Malzeme : EN 13600 Standardında elektrolitik bakır
Kaplama : Minimum 3 mikron (µm) Kalay Kaplama

Material : EN 13600 Standarts Electrolytically Tin (E-Cu) Plated Copper
 Plating : Minimum 3 microns (µm) Tin Plated

**** Koyu renk ile işaretlenmiş kablo pabuçları standart ürünlerimiz olup, diğer kalemler için lütfen stok durumunu sorunuz.**

**** Bold fonted items are our standart sizes, pls ask stock availability for other items.**

Standart Kablo Pabuçları - Eko Seri

Compression Cable Lugs - Eco Line

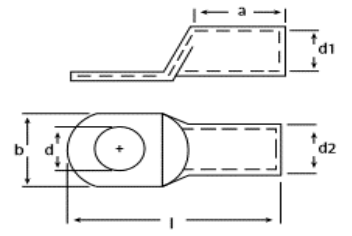

Ürün Kodu Product Code	Ürün Adı Product Name	Kesit Cross Sec. (mm ²)	Ölçüler / Dimensions (mm)						Delik Çapı Hole Dia.	Amb. Mik. Pack. Qty. (Adet/Pcs.)
			d	d1	d2	l	a	b		
8029320500	CCL-E 16 M6	16	6,5	5,5	7	32,5	11	10,5	M6	500
8029320510	CCL-E 16 M8	16	8,5	5,5	7	32,5	11	13	M8	500
8029320520	CCL-E 25 M8	25	8,5	7	9	38,5	16	13	M8	300
8029320530	CCL-E 35 M8	35	8,5	8,5	10,5	43,5	19	15,5	M8	200
8029320540	CCL-E 50 M10	50	10,5	10	12	51,5	21	17,6	M10	125
8029320550	CCL-E 70 M10	70	10,5	11,5	14	55,5	23	20,7	M10	100
8029320560	CCL-E 95 M12	95	13	13,5	16	58,5	26	23,5	M12	75
8029320570	CCL-E 120 M12	120	13	15,5	18	71	29	26,7	M12	50
8029320580	CCL-E 150 M12	150	13	16,5	20	76	30	29,2	M12	30
8029320590	CCL-E 185 M16	185	17	18,5	22	82	33	32,3	M16	25
8029320600	CCL-E 240 M16	240	17	21,5	25,5	91	38	37,6	M16	20

Malzeme : EN 13600 Standardında elektrolitik bakır
Kaplama : Minimum 3 mikron (µm) Kalay Kaplama

Material : EN 13600 Standarts Electrolytically Tin (E-Cu) Plated Copper
Plating : Minimum 3 microns (µm) Tin Plated



Standart Seri Ek Muflar

Standard Range Compression Butt Terminals

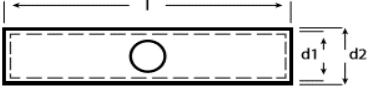

Ürün Kodu Product Code	Ürün Adı Product Name	Kesit Cross Sec. (mm ²)	Ölçüler / Dimensions (mm)			Amb. Mik. Pack. Qty. (Adet/Pcs.)
			d1	d2	l	
8029320845	CBT 10	10	4,4	6	27	400
8029320850	CBT 16	16	5,5	8	32	250
8029320860	CBT 25	25	7	9	40,5	200
8029320870	CBT 35	35	8,2	11	45,5	150
8029320880	CBT 50	50	9,5	13	53,5	80
8029320890	CBT 70	70	11,2	14,5	57,5	60
8029320900	CBT 95	95	13,4	17	61,5	40
8029320910	CBT 120	120	15	19,5	74	30
8029320920	CBT 150	150	16,5	21	79	25
8029320930	CBT 185	185	19	24	85	18
8029320940	CBT 240	240	21	26	95	13

Malzeme : EN 13600 Standardında elektrolitik bakır

Kaplama : Minimum 3 mikron (µm) Kalay Kaplama

Material : EN 13600 Standarts Electrolytically Tin (E-Cu) Plated Copper

Plating : Minimum 3 microns (µm) Tin Plated

Eko Seri Ek Muflar

Economical Range Compression Butt Terminals

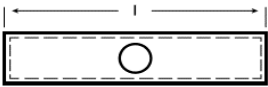

Ürün Kodu Product Code	Ürün Adı Product Name	Kesit Cross Sec. (mm ²)	Uzunluk Lenght (l) mm	Amb. Mik. Pack. Qty. (Adet/Pcs.)
8029320750	CBT-E 16	16	32	300
8029320760	CBT-E 25	25	41	200
8029320770	CBT-E 35	35	46	150
8029320780	CBT-E 50	50	54	125
8029320790	CBT-E 70	70	58	100
8029320800	CBT-E 95	95	62	60
8029320810	CBT-E 120	120	74	40
8029320820	CBT-E 150	150	80	30
8029320830	CBT-E 185	185	86	22
8029320840	CBT-E 240	240	95	15

Malzeme : EN 13600 Standardında elektrolitik bakır

Kaplama : Minimum 3 mikron (µm) Kalay Kaplama

Material : EN 13600 Standarts Electrolytically Tin (E-Cu) Plated Copper

Plating : Minimum 3 microns (µm) Tin Plated

Yuvarlak Pabuçlar

Insulated Ring Terminals

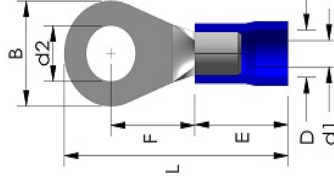

Ürün Kodu Product Code	Ürün Adı Product Name	Kesit Cross Sect. (mm ²)	Ölçüler Dimensions (mm)							Renk Color	Amb. Mik. Pack. Qty (Adet/Pcs.)
			d2	B	F	L	E	D	d1		
8018335500	IRT 301	0,5 - 1,5	3,2	5,5	4	16,7	10	4,1	1,7	Kırmızı / Red	200
8018335510	IRT 351	0,5 - 1,5	3,7	5,5	4	16,7	10	4,1	1,7	Kırmızı / Red	200
8018335520	IRT 401	0,5 - 1,5	4,3	6,6	6,3	19,6	10	4,1	1,7	Kırmızı / Red	200
8018335530	IRT 501	0,5 - 1,5	5,3	8	7	21	10	4,1	1,7	Kırmızı / Red	200
8018335540	IRT 601	0,5 - 1,5	6,5	11,6	11,1	26,8	10	4,1	1,7	Kırmızı / Red	200
8018335550	IRT 801	0,5 - 1,5	8,4	11,6	11,1	26,8	10	4,1	1,7	Kırmızı / Red	200
8018335560	IRT 302	1,5 - 2,5	3,2	6,4	4,3	17,5	10	4,5	2,3	Mavi / Blue	200
8018335570	IRT 402	1,5 - 2,5	4,3	6,6	6,3	19,5	10	4,5	2,3	Mavi / Blue	200
8018335580	IRT 502	1,5 - 2,5	5,3	8,5	7,8	22	10	4,5	2,3	Mavi / Blue	200
8018335590	IRT 602	1,5 - 2,5	6,5	12	11	27	10	4,5	2,3	Mavi / Blue	200
8018335600	IRT 802	1,5 - 2,5	8,4	12	11	27	10	4,5	2,3	Mavi / Blue	200
8018335610	IRT 1002	1,5 - 2,5	10,5	13,6	13,9	30,7	10	4,5	2,3	Mavi / Blue	100
8018335620	IRT 406	4,0 - 6,0	4,3	7,2	5,9	22	12,5	6,5	3,4	Sarı / Yellow	75
8018335630	IRT 506	4,0 - 6,0	5,3	9,5	8,3	25,5	12,5	6,5	3,4	Sarı / Yellow	75
8018335640	IRT 606	4,0 - 6,0	6,5	12	10,5	29	12,5	6,5	3,4	Sarı / Yellow	75
8018335650	IRT 806	4,0 - 6,0	8,4	15	13,7	33,7	12,5	6,5	3,4	Sarı / Yellow	75
8018335660	IRT 1006	4,0 - 6,0	10,5	15	13,7	33,7	12,5	6,5	3,4	Sarı / Yellow	75
8018335670	IRT 1206	4,0 - 6,0	13	19,2	16	38,1	12,5	6,5	3,4	Sarı / Yellow	75
8018335680	IRT 510	8,0 - 10,0	5,3	12	9,7	32,5	17	8	4,5	Kırmızı / Red	50
8018335690	IRT 610	8,0 - 10,0	6,7	12	9,7	32,5	17	8	4,5	Kırmızı / Red	50

* Malzeme: Bakır, Nikel Kaplı

* Material: Copper, Nickel Plated - PVC

Çatal Pabuçlar

Insulated Fork Terminals

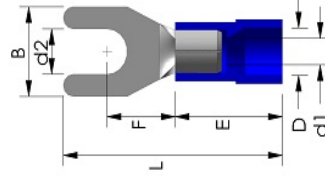

Ürün Kodu Product Code	Ürün Adı Product Name	Kesit Cross Sect. (mm ²)	Ölçüler Dimensions (mm)							Renk Color	Amb. Mik. Pack. Qty (Adet/Pcs.)
			d2	B	F	L	E	D	d1		
8018335700	IFT 301	0,5 - 1,5	3,2	5,8	6,3	21	10	4,1	1,7	Kırmızı / Red	200
8018335720	IFT 401	0,5 - 1,5	4,3	6,4	6,3	20,6	10	4,1	1,7	Kırmızı / Red	200
8018335730	IFT 501	0,5 - 1,5	5,3	8	7	21	10	4,1	1,7	Kırmızı / Red	200
8018335740	IFT 601	0,5 - 1,5	6,5	12	11	27,2	10	4,1	1,7	Kırmızı / Red	200
8018335750	IFT 302	1,5 - 2,5	3,2	5,8	6,3	21	10	4,2	2,3	Mavi / Blue	200
8018335760	IFT 402	1,5 - 2,5	4,3	6,4	6,3	21	10	4,2	2,3	Mavi / Blue	200
8018335770	IFT 502	1,5 - 2,5	5,3	9,5	7,2	22	10	4,2	2,3	Mavi / Blue	200
8018335780	IFT 602	1,5 - 2,5	6,5	12	11	27,2	10	4,2	2,3	Mavi / Blue	200
8018335790	IFT 406	4,0 - 6,0	4,3	8,5	7,5	25,2	12,5	6,5	3,4	Sarı / Yellow	75
8018335800	IFT 506	4,0 - 6,0	5,3	9,5	7,5	25,2	12,5	6,5	3,4	Sarı / Yellow	75
8018335810	IFT 606	4,0 - 6,0	6,5	9,5	7,5	25,2	12,5	6,5	3,4	Sarı / Yellow	75
8018335820	IFT 806	4,0 - 6,0	8,4	13,5	10,5	30	12,5	6,5	3,4	Sarı / Yellow	75

* Malzeme: Bakır, Nikel Kaplı

* Material: Copper, Nickel Plated - PVC

Faston Dişi Pabuçlar

Fast-on Female Terminals

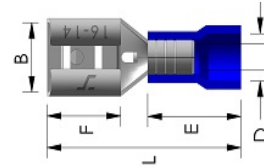

Ürün Kodu Product Code	Ürün Adı Product Name	Kesit Cross Sect. (mm ²)	Ölçüler Dimensions (mm)					Renk Color	Amb. Mik. Pack. Qty (Adet/Pcs.)
			B	F	L	E	D		
8018336030	FFT 1288	0,5 - 1,5	3,20	6,5	19,0	10,5	3,8	Kırmızı / Red	200
8018336100	FFT 1488	0,5 - 1,5	5,00	6,4	19,4	10,5	3,8	Kırmızı / Red	200
8018336110	FFT 1638	0,5 - 1,5	6,60	7,5	20,8	10,5	3,8	Kırmızı / Red	200
8018336115	FFT 2288	1,5 - 2,5	5,00	6,4	19,4	10,5	4,7	Mavi / Blue	150
8018336120	FFT 2488	1,5 - 2,5	6,60	7,5	20,8	10,5	4,7	Mavi / Blue	150
8018336130	FFT 2638	1,5 - 2,5	6,60	7,5	23,3	13,0	6,2	Mavi / Blue	150
8018336140	FFT 5638	4,0 - 6,0	6,6	7,2	23,3	13	5,6	Sarı / Yellow	100

* Malzeme: Pirinç, Kalay Kaplı

* Material: Brass, Tin Plated - PVC

İzoleli Faston Dişi Pabuçlar

Insulated Fast-on Female Terminals

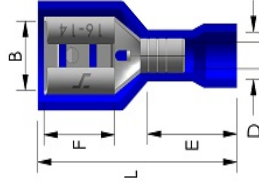

Ürün Kodu Product Code	Ürün Adı Product Name	Kesit Cross Sect. (mm ²)	Ölçüler Dimensions (mm)					Renk Color	Amb. Mik. Pack. Qty (Adet/Pcs.)
			B	F	L	E	D		
8018336300	IFFT 1288	0,5 - 1,5	3,2	6,5	19,00	10,50	3,8	Kırmızı / Red	200
8018336310	IFFT 1488	0,5 - 1,5	5	6,4	20,50	10,50	3,8	Kırmızı / Red	200
8018336320	IFFT 1638	0,5 - 1,5	6,6	7,5	21,80	10,50	3,8	Kırmızı / Red	100
8018336325	IFFT 2288	1,5 - 2,5	3,2	6,4	20,0	10	4,2	Mavi / Blue	100
8018336330	IFFT 2488	1,5 - 2,5	5	6,4	19,2	10	4,2	Mavi / Blue	100
8018336340	IFFT 2638	1,5 - 2,5	6,6	7,5	24,20	12,50	6,2	Mavi / Blue	100
8018336350	IFFT 5638	4,0 - 6,0	6,6	7,2	23,8	13	5,6	Sarı / Yellow	75

* Malzeme: Pirinç, Kalay Kaplı
* Material: Brass, Tin Plated - PVC

Faston Erkek Pabuçlar

Fast-on Male Terminals

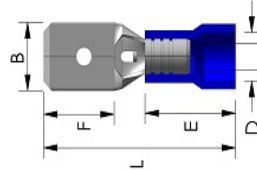

Ürün Kodu Product Code	Ürün Adı Product Name	Kesit Cross Sect. (mm ²)	Ölçüler Dimensions (mm)					Renk Color	Amb. Mik. Pack. Qty (Adet/Pcs.)
			B	F	L	E	D		
8018336150	FMT 1288	0,5 - 1,5	2,80	6,5	19,2	10,5	3,8	Kırmızı / Red	200
8018336160	FMT 1488	0,5 - 1,5	4,80	6,7	19,8	10,5	3,8	Kırmızı / Red	200
8018336170	FMT 1638	0,5 - 1,5	6,35	7,7	21,8	10,5	3,8	Kırmızı / Red	200
8018336175	FMT 2288	1,5 - 2,5	4,80	6,7	19,8	10,5	4,7	Mavi / Blue	200
8018336180	FMT 2488	1,5 - 2,5	4,80	7,7	21,8	10,5	4,7	Mavi / Blue	200
8018336190	FMT 2638	1,5 - 2,5	6,35	7,7	24,8	13,0	6,2	Mavi / Blue	200
8018336200	FMT 5638	4,0 - 6,0	6,3	7,7	24	13	5,6	Sarı / Yellow	100

* Malzeme: Pirinç, Kalay Kaplı
* Material: Brass, Tin Plated - PVC

Geri Dönüflü Pabuçlar

Piggy Back Terminals

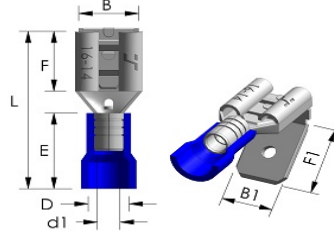

Ürün Kodu Product Code	Ürün Adı Product Name	Kesit Cross Sect. (mm ²)	Ölçüler Dimensions (mm)								Renk Color	Amb. Mik. Pack. Qty (Adet/Pcs.)
			B	B1	F	F1	L	E	D	d1		
8018336460	PBT 1638	0,5 - 1,5	6,6	6,3	8	8,2	22	10	3,5	1,7	Kırmızı / Red	100
8018336470	PBT 2638	1,5 - 2,5	6,6	6,3	8	8,2	22	10	4,2	2,3	Mavi / Blue	100
8018336480	PBT 5638	4,0 - 6,0	6,6	6,3	8	8,2	25	13	5,6	3,4	Sarı / Yellow	100

* **Malzeme: Bakır, Kalay Kaplı**
* Material: Copper, Tin Plated - PVC

İğne Tip Pabuçlar

Insulated Pin Terminals

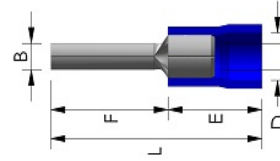

Ürün Kodu Product Code	Ürün Adı Product Name	Kesit Cross Sect. (mm ²)	Ölçüler Dimensions (mm)					Renk Color	Amb. Mik. Pack. Qty (Adet/Pcs.)
			B	F	L	E	D		
8018335900	IPT 1/1,5	0,5 - 1,5	1,9	10	20	10	4,0	Kırmızı / Red	200
8018335910	IPT 1/2,5	1,5 - 2,5	1,9	12	22	10	4,5	Mavi / Blue	200
8018335920	IPT 1/6	4,0 - 6,0	2,8	14	27	13	6,4	Sarı / Yellow	100

* **Malzeme: Bakır, Kalay Kaplı**
* Material: Copper, Tin Plated - PVC

Dişi Pabuçlar

Bullet Female Terminals

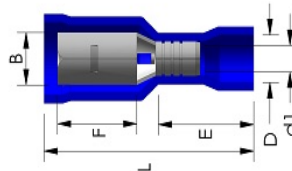

Ürün Kodu Product Code	Ürün Adı Product Name	Kesit Cross Sect. (mm ²)	Ölçüler Dimensions (mm)						Renk Color	Amb. Mik. Pack. Qty (Adet/Pcs.)
			B	F	L	E	D	d1		
8018336600	BFT 1040	0,5 - 1,5	3,9	7,3	23,5	10	3,5	1,7	Kırmızı / Red	100
8018336610	BFT 2050	1,5 - 2,5	4,9	8,5	25	10	4,2	2,3	Mavi / Blue	100
8018336620	BFT 5050	4,0 - 6,0	4,9	8,5	28	13	5,6	3,4	Sarı / Yellow	50

* **Malzeme: Bakır, Kalay Kaplı**
* Material: Copper, Tin Plated - PVC

Erkek Pabuçlar

Bullet Male Terminals

EAC

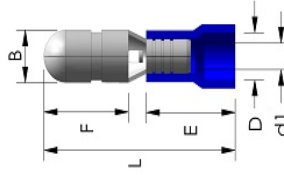

Ürün Kodu Product Code	Ürün Adı Product Name	Kesit Cross Sect. (mm ²)	Ölçüler Dimensions (mm)						Renk Color	Amb. Mik. Pack. Qty (Adet/Pcs.)
			B	F	L	E	D	d1		
8018336700	BMT 1040	0,5 - 1,5	4	8,5	21	10	3,5	1,7	Kırmızı / Red	100
8018336710	BMT 2050	1,5 - 2,5	5	9	21,5	10	4,2	2,3	Mavi / Blue	100
8018336720	BMT 5050	4,0 - 6,0	5	9	24,5	13	5,6	3,4	Sarı / Yellow	100

* Malzeme: Bakır, Kalay Kaplı
* Material: Copper, Tin Plated - PVC

Ek Muflar

Insulated Butt Terminals

EAC

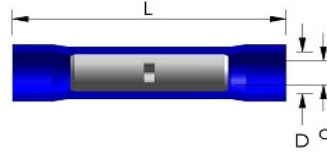

Ürün Kodu Product Code	Ürün Adı Product Name	Kesit Cross Sect. (mm ²)	Ölçüler Dimensions (mm)			Renk Color	Amb. Mik. Pack. Qty (Adet/Pcs.)
			L	D	d		
8018336500	IBT 251	0,5 - 1,5	24,5	4,3	1,7	Kırmızı / Red	100
8018336510	IBT 252	1,5 - 2,5	24,5	4,8	2,3	Mavi / Blue	100
8018336520	IBT 256	4,0 - 6,0	27	6,2	3,4	Sarı / Yellow	100

* Malzeme: Bakır, Kalay Kaplı
* Material: Copper, Tin Plated - PVC

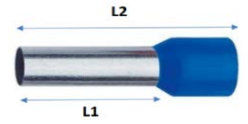

İzoleli Kablo Yüksükleri

Insulated End Sleeves



Ürün Kodu Product Code	Ürün Adı Product Name	Ölçüler Dimensions (mm)		Kesit Cross Sect. (mm ²)	AWG	Norm	Amb. Mik. Pack. Qty (Adet/Pcs.)
		L1	L2				
8017335000	IES 0,50/8 Turuncu / Orange	8	12	0,5	20	Alman / German	1.000
8017335010	IES 0,75/8 Beyaz / White	8	14	0,75	18	Alman / German	1.000
8017335020	IES 1,0/8 Sarı / Yellow	8	14	1	17	Alman / German	1.000
8017335030	IES 1,5/8 Kırmızı / Red	8	14	1,5	16	Alman / German	1.000
8017335040	IES 2,5/8 Mavi / Blue	8	14	2,5	14	Alman / German	500
8017335050	IES 4,0/10 Gri / Gray	10	17	4	12	Alman / German	500
8017335060	IES 6,0/12 Siyah / Black	12	20	6	10	Alman / German	250
8017335070	IES 10,0/12 Fildişi / Ivory	12	22	10	8	Alman / German	100
8017335080	IES 16,0/12 Yeşil / Green	12	24	16	6	Alman / German	100
8017335090	IES 25,0/16 Kahve / Brown	16	28	25	4	Alman / German	50
8017335100	IES 35,0/16 Bej / Beige	16	30	35	2	Alman / German	50
8017335110	IES 50,0/20 Zeytin Yeşili / Olive Green	20	36	50	1	Alman / German	25

Ürün Kodu Product Code	Ürün Adı Product Name	Ölçüler Dimensions (mm)		Kesit Cross Sect. (mm ²)	AWG	Norm	Amb. Mik. Pack. Qty (Adet/Pcs.)
		L1	L2				
8017335005	IES 0,50/8 Beyaz / White	8	12	0,5	20	Fransız / French	1.000
8017335015	IES 0,75/8 Mavi / Blue	8	14	0,75	18	Fransız / French	1.000
8017335025	IES 1,0/8 Kırmızı / Red	8	14	1	17	Fransız / French	1.000
8017335035	IES 1,5/8 Siyah / Black	8	14	1,5	16	Fransız / French	1.000
8017335045	IES 2,5/8 Gri / Gray	8	14	2,5	14	Fransız / French	500
8017335055	IES 4,0/10 Turuncu / Orange	10	17	4	12	Fransız / French	500
8017335065	IES 6,0/12 Yeşil / Green	12	20	6	10	Fransız / French	250
8017335075	IES 10,0/12 Kahve / Brown	12	22	10	8	Fransız / French	100
8017335085	IES 16,0/12 Bej / Beige	12	24	16	6	Fransız / French	100
8017335095	IES 25,0/16 Siyah / Black	16	28	25	4	Fransız / French	50
8017335105	IES 35,0/16 Kırmızı / Red	16	30	35	2	Fransız / French	50
8017335115	IES 50,0/20 Mavi / Blue	20	36	50	1	Fransız / French	25
8017335125	IES 70,0/20 Sarı / Yellow	20	37	70	1	Fransız / French	25

* Malzeme: Bakır, Kalay Kaplı

* Material: Copper, Tin Plated - PVC



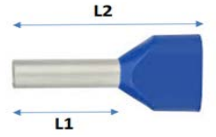

Çift Girişli Kablo Yüksükleri

Twin Cord End Sleeves



Ürün Kodu Product Code	Ürün Adı Product Name	Ölçüler Dimensions (mm)		Kesit Cross Sect. (mm ²)	Norm	Amb. Mik. Pack. Qty (Adet/Pcs.)
		L1	L2			
8017335400	IES 2x0,50/8 Turuncu / Orange	8	14	2 x 0,5	Alman / German	1.000
8017335410	IES 2x0,75/8 Beyaz / White	8	14	2 x 0,75	Alman / German	500
8017335420	IES 2x1,0/8 Sarı / Yellow	8	14	2 x 1,0	Alman / German	500
8017335430	IES 2x1,5/8 Kırmızı / Red	8	14	2 x 1,5	Alman / German	500
8017335440	IES 2x2,5/10 Mavi / Blue	10	14	2 x 2,5	Alman / German	250
8017335450	IES 2x4,0/12 Gri / Gray	12	17	2 x 4,0	Alman / German	200
8017335460	IES 2x6,0/14 Siyah / Black	14	20	2 x 6,0	Alman / German	100
8017335470	IES 2x10,0/14 Fildişi / Ivory	14	27	2 x 10	Alman / German	50
8017335480	IES 2x16,0/14 Yeşil / Green	14	31	2 x 16	Alman / German	50

Ürün Kodu Product Code	Ürün Adı Product Name	Ölçüler Dimensions (mm)		Kesit Cross Sect. (mm ²)	Norm	Amb. Mik. Pack. Qty (Adet/Pcs.)
		L1	L2			
8017335405	IES 2x0,50/8 Beyaz / White	8	14	2 x 0,5	Fransız / French	1.000
8017335415	IES 2x0,75/8 Mavi / Blue	8	14	2 x 0,75	Fransız / French	500
8017335425	IES 2x1,0/8 Kırmızı / Red	8	14	2 x 1,0	Fransız / French	500
8017335435	IES 2x1,5/8 Siyah / Black	8	14	2 x 1,5	Fransız / French	500
8017335445	IES 2x2,5/10 Gri / Gray	10	14	2 x 2,5	Fransız / French	250
8017335455	IES 2x4,0/12 Turuncu / Orange	12	17	2 x 4,0	Fransız / French	200
8017335465	IES 2x6,0/14 Yeşil / Green	14	20	2 x 6,0	Fransız / French	100
8017335475	IES 2x10,0/14 Kahve / Brown	14	27	2 x 10	Fransız / French	50
8017335485	IES 2x16,0/14 Bej / Beige	14	31	2 x 16	Fransız / French	50

* Malzeme: Bakır, Kalay Kaplı
* Material: Copper, Tin Plated - PVC



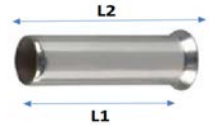

İzolesiz Kablo Yüksükleri

Non-insulated End Sleeves



Ürün Kodu Product Code	Ürün Adı Product Name	Ölçüler Dimensions (mm)		Kesit Cross Sect. (mm ²)	AWG	Amb. Mik. Pack. Qty (Adet/Pcs.)
		L1	L2			
8017335220	ES 0,50/10	8	10	0,50	20	2.000
8017335230	ES 0,75/10	8	10	0,75	18	2.000
8017335240	ES 1,0/10	8	10	1,00	17	2.000
8017335250	ES 1,5/10	8	10	1,50	15	2.000
8017335260	ES 2,5/12	8	12	2,50	13	2.000
8017335270	ES 4,0/12	10	12	4,00	11	1.000
8017335280	ES 6,0/12	10	12	6,00	9	500
8017335290	ES 10,0/15	12	15	10,00	7	200
8017335300	ES 16,0/15	12	15	16,00	5	200
8017335310	ES 25,0/16	16	16	25,00	4	100
8017335320	ES 35,0/16	16	16	35,00	2	100
8017335330	ES 50,0/20	20	20	50,00	1	50

* Malzeme: Bakır, Kalay Kaplı

* Material: Copper, Tin Plated - PVC



Ledli Sinyal Lambaları - Ø22 mm

LED Indicators - Ø22 mm



Ürün Kodu Product Code	Ürün Adı Product Name		Nominal Gerilim Nominal Voltage (V)	Renk Color	Amb. Mik. Pack. Qty (Adet/Pcs.)
8026088912	SIL-X22-220 AC Kırmızı	SIL-X22-220 Red Signal Lamp with LED	220V AC	●	25
8026088914	SIL-X22-220 AC Sarı	SIL-X22-220 Yellow Signal Lamp with LED	220V AC	●	25
8026088915	SIL-X22-220 AC Yeşil	SIL-X22-220 Green Signal Lamp with LED	220V AC	●	25
8026088916	SIL-X22-220 AC Mavi	SIL-X22-220 Blue Signal Lamp with LED	220V AC	●	25
8026088919	SIL-X22-220 AC Beyaz	SIL-X22-220 White Signal Lamp with LED	220V AC	○	25
8026088922	SIL-X22-220 AC/DC Kırmızı	SIL-X22-220 DC Red Signal Lamp with LED	220V DC	●	25
8026088924	SIL-X22-220 AC/DC Sarı	SIL-X22-220 DC Yellow Signal Lamp with LED	220V DC	●	25
8026088925	SIL-X22-220 AC/DC Yeşil	SIL-X22-220 DC Green Signal Lamp with LED	220V DC	●	25
8026088926	SIL-X22-220 AC/DC Mavi	SIL-X22-220 DC Blue Signal Lamp with LED	220V DC	●	25
8026088929	SIL-X22-220 AC/DC Beyaz	SIL-X22-220 DC White Signal Lamp with LED	220V DC	○	25

Ürün Kodu Product Code	Ürün Adı Product Name		Nominal Gerilim Nominal Voltage (V)	Renk Color	Amb. Mik. Pack. Qty (Adet/Pcs.)
8026078912	SIL22-220 Kırmızı Sinyal Lambası Ledli	SIL22-220 Red Signal Lamp with LED	220V AC	●	25
8026078915	SIL22-220 Yeşil Sinyal Lambası Ledli	SIL22-220 Green Signal Lamp with LED	220V AC	●	25
8026078914	SIL22-220 Sarı Sinyal Lambası Ledli	SIL22-220 Yellow Signal Lamp with LED	220V AC	●	25
8026078916	SIL22-220 Mavi Sinyal Lambası Ledli	SIL22-220 Blue Signal Lamp with LED	220V AC	●	25
8026078919	SIL22-220 Beyaz Sinyal Lambası Ledli	SIL22-220 White Signal Lamp with LED	220V AC	○	25
8026078922	SIL22-220DC Kırmızı Sinyal Lambası Ledli	SIL22-220DC Red Signal Lamp with LED	220V DC	●	25
8026078925	SIL22-220DC Yeşil Sinyal Lambası Ledli	SIL22-220DC Green Signal Lamp with LED	220V DC	●	25
8026078924	SIL22-220DC Sarı Sinyal Lambası Ledli	SIL22-220DC Yellow Signal Lamp with LED	220V DC	●	25
8026078926	SIL22-220DC Mavi Sinyal Lambası Ledli	SIL22-220DC Blue Signal Lamp with LED	220V DC	●	25
8026078929	SIL22-220DC Beyaz Sinyal Lambası Ledli	SIL22-220DC White Signal Lamp with LED	220V DC	○	25
8026078932	SIL22-110 Kırmızı Sinyal Lambası Ledli	SIL22-110 Red Signal Lamp with LED	110V AC/DC	●	25
8026078935	SIL22-110 Yeşil Sinyal Lambası Ledli	SIL22-110 Green Signal Lamp with LED	110V AC/DC	●	25
8026078934	SIL22-110 Sarı Sinyal Lambası Ledli	SIL22-110 Yellow Signal Lamp with LED	110V AC/DC	●	25
8026078936	SIL22-110 Mavi Sinyal Lambası Ledli	SIL22-110 Blue Signal Lamp with LED	110V AC/DC	●	25
8026078939	SIL22-110 Beyaz Sinyal Lambası Ledli	SIL22-110 White Signal Lamp with LED	110V AC/DC	○	25
8026078942	SIL22-24 Kırmızı Sinyal Lambası Ledli	SIL22-24 Red Signal Lamp with LED	24V AC/DC	●	25
8026078945	SIL22-24 Yeşil Sinyal Lambası Ledli	SIL22-24 Green Signal Lamp with LED	24V AC/DC	●	25
8026078944	SIL22-24 Sarı Sinyal Lambası Ledli	SIL22-24 Yellow Signal Lamp with LED	24V AC/DC	●	25
8026078946	SIL22-24 Mavi Sinyal Lambası Ledli	SIL22-24 Blue Signal Lamp with LED	24V AC/DC	●	25
8026078949	SIL22-24 Beyaz Sinyal Lambası Ledli	SIL22-24 White Signal Lamp with LED	24V AC/DC	○	25

Yaylı Kumanda Butonları - Ø22 mm

Push Buttons Spring Return - Ø22 mm



Ürün Kodu Product Code	Ürün Adı Product Name	Kontakt Contact	Renk Color	Amb. Mik. Pack. Qty (Adet/Pcs.)
8025078002	PSR-1C Kırmızı Düz Yaylı Tip 1 NK	1 NK	Red	15
8025078075	PSR-1O Yeşil Düz Yaylı Tip 1 NA	1 NA	Green	15
8025078104	PSR-1O Sarı Düz Yaylı Tip 1 NA	1 NA	Yellow	15
8025078106	PSR-1O Mavi Düz Yaylı Tip 1 NA	1 NA	Blue	15
8025078109	PSR-1O Beyaz Düz Yaylı Tip 1 NA	1 NA	White	15
8025078100	PSR-1O Siyah Düz Yaylı Tip 1 NA	1 NA	Black	15

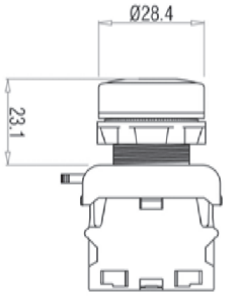

PSR-10 Sarı/Yellow



PSR-1C Kırmızı/Red



PSR-1O Yeşil/Green

Silikon Kılıf - Ø22 mm

Silicon Cover - Ø22 mm

Ürün Kodu Product Code	Ürün Adı Product Name	Amb. Mik. Pack. Qty (Adet/Pcs.)
8025078000	PSR-IP Şeffaf Silikon Buton Koruma Kılıfı	50



LED'li Yaylı Kumanda Butonları - Ø 22 mm

Push Buttons Spring Return LED - Ø 22 mm



Ürün Kodu Product Code	Ürün Adı Product Name	Nominal Gerilim (V) Nominal Voltage (V)	Renk Color	Amb. Mik. Pack. Qty (Adet/Pcs.)
8025078022	PSRL-1C 220 Kırmızı Düz Yaylı Tip 1 NK Ledli	220 V AC/DC	Red	15
8025078085	PSRL-1O 220 Yeşil Düz Yaylı Tip 1 NA Ledli	220 V AC/DC	Green	15
8025078224	PSRL-1O 220 Sarı Düz Yaylı Tip 1 NA Ledli	220 V AC/DC	Yellow	15
8025078226	PSRL-1O 220 Mavi Düz Yaylı Tip 1 NA Ledli	220 V AC/DC	Blue	15
8025078229	PSRL-1O 220 Beyaz Düz Yaylı Tip 1 NA Ledli	220 V AC/DC	White	15
8025078032	PSRL-1C 110 Kırmızı Düz Yaylı Tip 1 NK Ledli	110 V AC/DC	Red	15
8025078095	PSRL-1O 110 Yeşil Düz Yaylı Tip 1 NA Ledli	110 V AC/DC	Green	15
8025078234	PSRL-1O 110 Sarı Düz Yaylı Tip 1 NA Ledli	110 V AC/DC	Yellow	15
8025078236	PSRL-1O 110 Mavi Düz Yaylı Tip 1 NA Ledli	110 V AC/DC	Blue	15
8025078239	PSRL-1O 110 Beyaz Düz Yaylı Tip 1 NA Ledli	110 V AC/DC	White	15
8025078042	PSRL-1C 48 Kırmızı Düz Yaylı Tip 1 NK Ledli	48 V AC/DC	Red	15
8025078205	PSRL-1O 48 Yeşil Düz Yaylı Tip 1 NA Ledli	48 V AC/DC	Green	15
8025078204	PSRL-1O 48 Sarı Düz Yaylı Tip 1 NA Ledli	48 V AC/DC	Yellow	15
8025078206	PSRL-1O 48 Mavi Düz Yaylı Tip 1 NA Ledli	48 V AC/DC	Blue	15
8025078209	PSRL-1O 48 Beyaz Düz Yaylı Tip 1 NA Ledli	48 V AC/DC	White	15
8025078052	PSRL-1C 24 Kırmızı Düz Yaylı Tip 1 NK Ledli	24 V AC/DC	Red	15
8025078215	PSRL-1O 24 Yeşil Düz Yaylı Tip 1 NA Ledli	24 V AC/DC	Green	15
8025078214	PSRL-1O 24 Sarı Düz Yaylı Tip 1 NA Ledli	24 V AC/DC	Yellow	15
8025078216	PSRL-1O 24 Mavi Düz Yaylı Tip 1 NA Ledli	24 V AC/DC	Blue	15
8025078219	PSRL-1O 24 Beyaz Düz Yaylı Tip 1 NA Ledli	24 V AC/DC	White	15

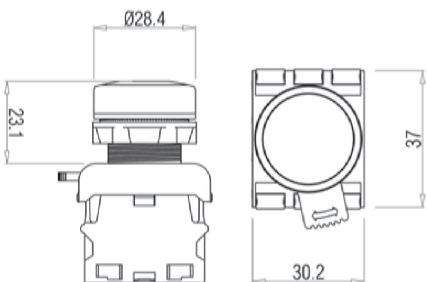

PSRL-1C Kırmızı/Red



PSRL-1O Yeşil/Green



PSRL-1O Mavi/Blue

Çiftli, Yaylı Kumanda Butonları - Ø 22 mm

Double Spring Push Button - Ø22 mm



Ürün Kodu Product Code	Ürün Adı Product Name	Kontakt Contact	Renk Color	Amb. Mik. Pack. Qty (Adet/Pcs.)
8025078302	DSR-1C10 Çiftli Yaylı Tip 1NA+1NK	DSR-1C10 Double Spring Return 1NO+1NC	1 NA + 1 NK	10
8025078312	DSRL-1C10 220 Çiftli Yaylı Tip 1NA+1NK Ledli	DSRL-1C10 220 Double Spring Return 1NO+1NC with LED	1 NA + 1 NK	10
8025078362	DSRL-1C10 110 Çiftli Yaylı Tip 1NA+1NK Ledli	DSRL-1C10 110 Double Spring Return 1NO+1NC with LED	1 NA + 1 NK	10
8025078372	DSRL-1C10 24 Çiftli Yaylı Tip 1NA+1NK Ledli	DSRL-1C10 24 Double Spring Return 1NO+1NC with LED	1 NA + 1 NK	10
8025079002	DSR-20 Ciftli yayli Tip 2NA	DSR-20 Double Spring Return 2NO	2 NA	10
8025079012	DSRL-20 220 Ciftli yayli Tip 2NA Ledli	DSRL-20 220 Double Spring Return 2NO with LED	2 NA	10
8025079062	DSRL-20 110 Ciftli yayli Tip 2NA Ledli	DSRL-20 110 Double Spring Return 2NO with LED	2 NA	10
8025079072	DSRL-20 24 Ciftli yayli Tip 2NA Ledli	DSRL-20 24 Double Spring Return 2NO with LED	2 NA	10

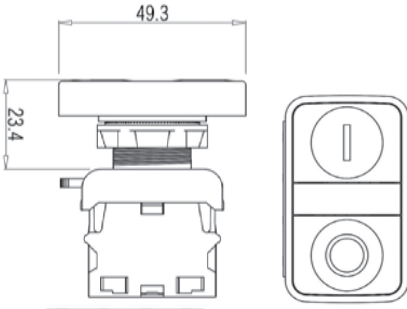

DSR-1C10

Acil Stop Kumanda Butonları - Ø 22 mm

Emergency Stop - Ø 22 mm



Ürün Kodu Product Code	Ürün Adı Product Name	Kontakt Contact	Renk Color	Amb. Mik. Pack. Qty (Adet/Pcs.)
8025078012	EPB-1C Acil Stop 1 NK	EPB-1C Emergency Stop 1 NC	1NK	10
8025078880	C-EPB - Acil Stop Koruma Kılıfı	C-EPB - Emergency Stop Protection Cover	--	1

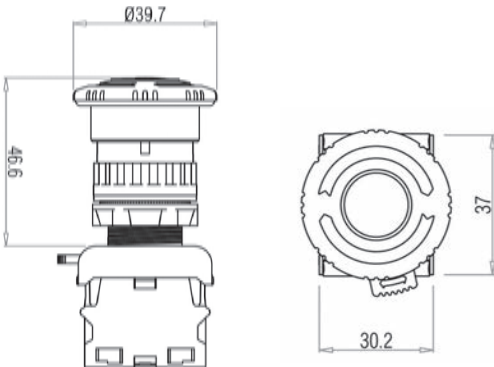

C-EPB



EPB-1C

Kalıcı Tip Seçici Butonlar - Ø 22 mm

Selector Switches Maintained - Ø22 mm



Ürün Kodu Product Code	Ürün Adı Product Name	Kontakt Contac	Renk Color	Pozisyon Position	Amb. Mik. Pack. Qty (Adet/Pcs.)
8025078500	SSP-10 Kalıcı 0-1 Seçici Buton	1 NA	●	<pre> 0 1 \ / </pre>	12
8025078501	SSP-1C10 Kalıcı 1-0-2 Seçici Buton	1 NA + 1NK	●	<pre> 1 0 2 \ / \ / </pre>	12
8025078510	SSP-20 Kalıcı 1-0-2 Seçici Buton	2 NA	●	<pre> 1 0 2 \ / \ / </pre>	12

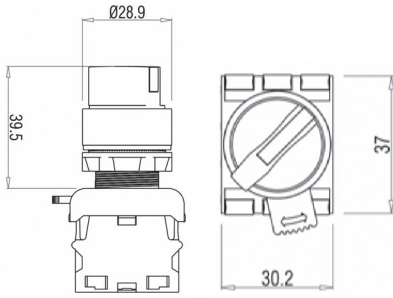

SSP-20

LED'li Kalıcı Tip Seçici Butonlar - Ø 22 mm

Selector Switches Maintained with LED - Ø22 mm



Ürün Kodu Product Code	Ürün Adı Product Name	Nominal Gerilim (V) Nominal Voltage (V)	Renk Color	Pozisyon Position	Amb. Mik. Pack. Qty (Adet/Pcs.)
8025078602	SSP-10 220 L Kırmızı Kalıcı Işıklı 0-1 Seçici Buton	220 V AC/DC	●	<pre> 0 1 \ / </pre>	12
8025078605	SSP-10 220 L Yeşil Kalıcı Işıklı 0-1 Seçici Buton	220 V AC/DC	●	<pre> 0 1 \ / </pre>	12
8025078604	SSP-10 220 L Sarı Kalıcı Işıklı 0-1 Seçici Buton	220 V AC/DC	●	<pre> 0 1 \ / </pre>	12
8025078622	SSP-20 220 L Kırmızı Kalıcı Işıklı 1-0-2 Seçici Buton	220 V AC/DC	●	<pre> 1 0 2 \ / \ / </pre>	12
8025078615	SSP-20 220 L Yeşil Kalıcı Işıklı 1-0-2 Seçici Buton	220 V AC/DC	●	<pre> 1 0 2 \ / \ / </pre>	12
8025078614	SSP-20 220 L Sarı Kalıcı Işıklı 1-0-2 Seçici Buton	220 V AC/DC	●	<pre> 1 0 2 \ / \ / </pre>	12

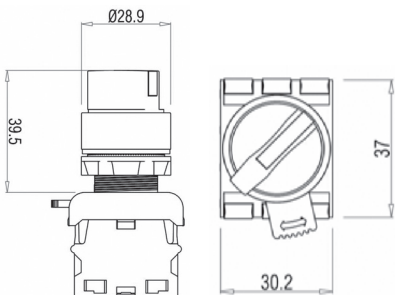

SSP-10 220 L Yeşil/Green



SSP-10 220 L Kırmızı/Red

LED'li Tip Yay Dönüflü Seçi Butonlar - Ø 22 mm

Selector Switch Momentary with LED - Ø22 mm



Ürün Kodu Product Code	Ürün Adı Product Name	Nominal Gerilim (V) Nominal Voltage (V)	Renk Color	Pozisyon Position	Amb. Mik. Pack. Qty (Adet/Pcs.)
8025078402	SSM-10 220 L Kırmızı Yay Dönüflü Işıklı 0-1 Seçi Buton SSM-10 220 L, 1NO 90° with LED	220 V AC/DC	●	0 1	12
8025078405	SSM-10 220 L Yeşil Yay Dönüflü Işıklı 0-1 Seçi Buton SSM-10 220 L, 2 position 1NO 90° with LED	220 V AC/DC	●	0 1	12
8025078404	SSM-10 220 L Sarı Yay Dönüflü Işıklı 0-1 Seçi Buton SSM-10 220 L, 2 position 1NO 90° with LED	220 V AC/DC	●	0 1	12
8025078422	SSM-20 220 L Kırmızı Yay Dönüflü Işıklı 1-0-2 Seçi Buton SSM-20 220 L, 3 position 2NC 60° with LED	220 V AC/DC	●	1 0 2	12
8025078415	SSM-20 220 L Yeşil Yay Dönüflü Işıklı 1-0-2 Seçi Buton SSM-20 220 L, 3 position 2NO 60° with LED	220 V AC/DC	●	1 0 2	12
8025078424	SSM-20 220 L Sarı Yay Dönüflü Işıklı 1-0-2 Seçi Buton SSM-20 220 L, 3 position 2NO 60° with LED	220 V AC/DC	●	1 0 2	12

Yay Dönüflü Seçi Butonlar - Ø 22 mm

Selector Switch Momentary - Ø22 mm



Ürün Kodu Product Code	Ürün Adı Product Name	Kontakt Contact	Renk Color	Pozisyon Position	Amb. Mik. Pack. Qty (Adet/Pcs.)
8025078320	SSM-10 Yay Dönüflü 0-1 Seçi Buton SSM-10, 2 position 1NO 90°	1 NA	●	0 1	12
8025078330	SSM-20 Yay Dönüflü 1-0-2 Seçi Buton SSM-20, 3 position 2NO 60°	2 NA	●	1 0 2	12

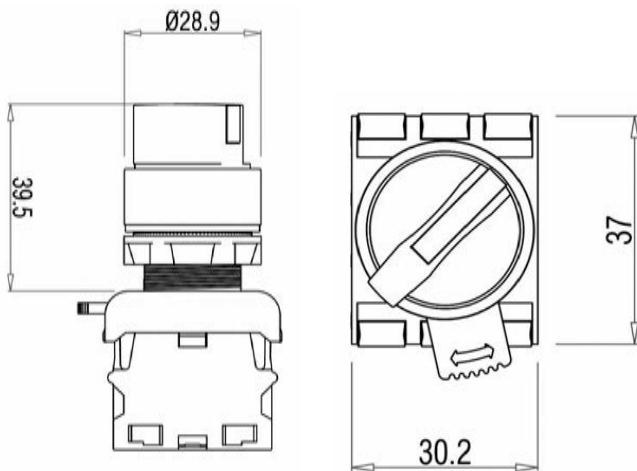

SMM-10

LED li Kalıcı ve Yaylı Tip Seçi Butonların 110V AC/DC ve 24V AC/DC Nominal Gerilimleri için lütfen satış temsilcinizle irtibata geçiniz.

Kontak Blok Tipleri

Contact Block Types



Ürün Kodu Product Code	Ürün Adı Product Name	Kontak Contact	Amb. Mik. Pack. Qty (Adet/Pcs.)
8025078800	CNT-O NA Kontak	CNT-O NO Contact	50
8025078810	CNT-C NK Kontak	CNT-C NC Contact	50
8025078820	CNT-S Işık Kontak Blok	CNT-S Signal Contact	50

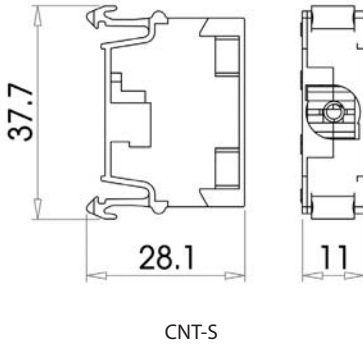
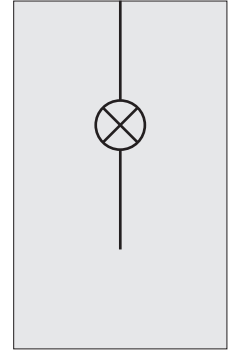
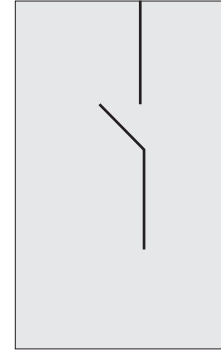
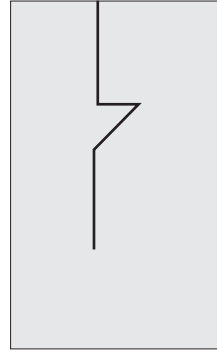
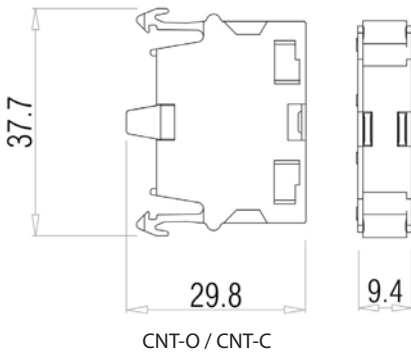

Teknik Bilgiler / Technical Information

Standart / Standard	IEC 60947-5-1
Çalışma Sıcaklığı min/maks. / Operating Temperature min/max (°C)	-5 / +40
Kirlilik Derecesi / Pollution Severity	3
Yalıtım Gerilimi / Rated Insulation Voltage (V)	400
Darbe Beyan Gerilimi / Rated Impulse Withstand Voltage (kV)	4
Klasik Açık hava Termal Akım / Conventional Thermal Current (A)	10
Kullanım Sınıfı / Utilization Category	AC 15
Nominal Çalışma Gerilimi / Rated Operational Voltage (V)	Nominal Çalışma Akımı / Rated Operational Current (A)
380	1,9
240	3
120	6

tbloc

Electrical & Electronic Manufacturing

ENDÜSTRİYEL ve PLC RÖLELER

İnce Tip Endüstriyel Röle

Kalın Tip Endüstriyel Röle

Vida Bağlantılı PLC Röle

Röle Soketi (Vidalı ve Push-in)

Röle Tutucu, Ekstra Klipsler

Harici Led Modülleri

Markalama

INDUSTRIAL and INTERFACE RELAYS

Compact Industrial Relays

Plug-In Industrial Relays

Screw Type Interface Relay

Relay Socket (Screw and Push-In)

Relay Holder, Support Clips

External Led Modul

Marking

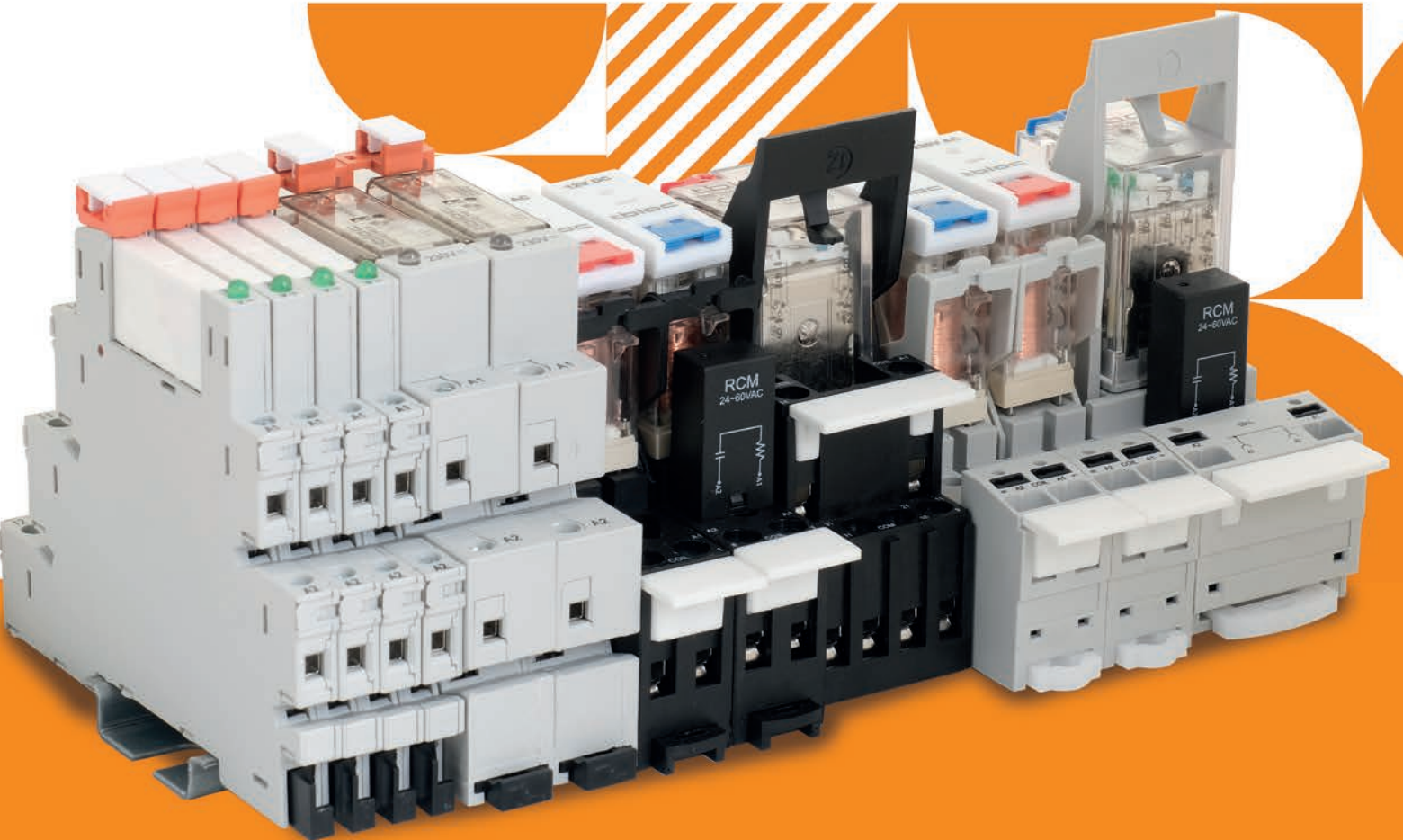

1CO 10A İnce Tip Endüstriyel Röle Compact Industrial Relay

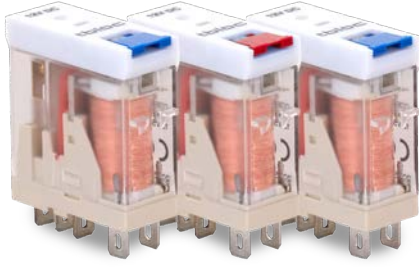

Ürün Kodu Product Code	Ürün Adı Product Name	Açıklama Explanation	Amb. Mik. Pack. Qty (Adet/Pcs.)
8036311200	TRS LT-1C-12A-12 V DC	1CO, 10A, 12V DC, LED+Test Butonlu Kompakt Röle / Test Button Compact Relay	20
8036311210	TRS LT-1C-12A-24 V DC	1CO, 10A, 24V DC, LED+Test Butonlu Kompakt Röle / Test Button Compact Relay	20
8036311220	TRS LT-1C-12A-48 V DC	1CO, 10A, 48V DC, LED+Test Butonlu Kompakt Röle / Test Button Compact Relay	20
8036311230	TRS LT-1C-12A-110 V DC	1CO, 10A, 110V DC, LED+Test Butonlu Kompakt Röle / Test Button Compact Relay	20
8036311240	TRS LT-1C-12A-24 V AC	1CO, 10A, 24V AC, LED+Test Butonlu Kompakt Röle / Test Button Compact Relay	20
8036311270	TRS LT-1C-12A-230 V AC	1CO, 10A, 230V AC, LED+Test Butonlu Kompakt Röle / Test Button Compact Relay	20

Aksesuarlar Accessories



Ürün Kodu Product Code	Ürün Adı Product Name	Açıklama Explanation	Amb. Mik. Pack. Qty (Adet/Pcs.)
8036012000	TS-V TRS 1C	1 Kontaklı Vidalı Röle Soketi / 1 Screw Relay Socket	20
8036212000	TS-P TRS 1C	1 Kontaklı Push-In Röle Soketi / 1 Push-In Relay Socket	20
8036330100	MARK- TRS	Etiket (Röle ile birlikte set olarak verilmektedir) / Marking Tag (Arriving as set with relay)	50
8036330060	LED FC R 6-24 VAC/DC	Harici Led Modülü / External Led Modul	5
8036330000	CP- TRS	Plastik Röle Tutucu / Plastic Relay Holder	20
8036331003	JP TS-P-2C-8	TRS Serisi için 8 Kutuplu Köprü / 8 pole jumper for TRS Series	5

2CO 8A İnce Tip Endüstriyel Röle Compact Industrial Relay

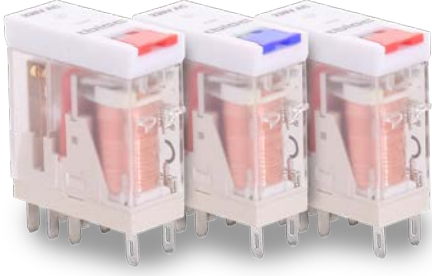

Ürün Kodu Product Code	Ürün Adı Product Name	Açıklama Explanation	Amb. Mik. Pack. Qty (Adet/Pcs.)
8036312800	TRS LT-2C-8A-12 V DC	2CO, 8A, 12V DC, LED+Test Butonlu Kompakt Röle / Test Button Compact Relay	20
8036312810	TRS LT-2C-8A-24 V DC	2CO, 8A, 24V DC, LED+Test Butonlu Kompakt Röle / Test Button Compact Relay	20
8036312820	TRS LT-2C-8A-48 V DC	2CO, 8A, 48V DC, LED+Test Butonlu Kompakt Röle / Test Button Compact Relay	20
8036312830	TRS LT-2C-8A-110 V DC	2CO, 8A, 110V DC, LED+Test Butonlu Kompakt Röle / Test Button Compact Relay	20
8036312840	TRS LT-2C-8A-24 V AC	2CO, 8A, 24V AC, LED+Test Butonlu Kompakt Röle / Test Button Compact Relay	20
8036312860	TRS LT-2C-8A-115 V AC	2CO, 8A, 115V AC, LED+Test Butonlu Kompakt Röle / Test Button Compact Relay	20
8036312870	TRS LT-2C-8A-230 V AC	2CO, 8A, 230V AC, LED+Test Butonlu Kompakt Röle / Test Button Compact Relay	20

Aksesuarlar Accessories



Ürün Kodu Product Code	Ürün Adı Product Name	Açıklama Explanation	Amb. Mik. Pack. Qty (Adet/Pcs.)
8036012001	TS-V TRS 2C	2 Kontaklı Vidalı Röle Soketi / 2C Relay Socket	20
8036212001	TS-P TRS 2C	2 Kontaklı Push-İn Röle Soketi / 2C Push-İn Relay Socket	20
8036330100	MARK- TRS	Etiket (Röle ile birlikte set olarak verilmektedir) / Marking Tag (Arriving as set with relay)	50
8036330060	LED FC R 6-24 VAC/DC	Harici Led Modülü / External Led Modul	5
8036330000	CP- TRS	Plastik Röle Tutucu / Plastic Relay Holder	20
8036331003	JP TS-P-2C-8	TRS Serisi için 8 Kutuplu Köprü / 8 pole jumper for TRS Series	5

**2CO 10A Kalın Tip Endüstriyel Röle
Plug-In Industrial Relay**



Ürün Kodu Product Code	Ürün Adı Product Name	Açıklama Explanation	Amb. Mik. Pack. Qty (Adet/Pcs.)
8036322010	TRB LT-2C-10A-24 V DC	2CO, 10A, 24V DC, LED+Test Butonlu Röle / Test Button Plug-In Industrial Relay	20
8036322020	TRB LT-2C-10A-48 V DC	2CO, 10A, 48V DC, LED+Test Butonlu Röle / Test Button Plug-In Industrial Relay	20
8036322030	TRB LT-2C-10A-110 V DC	2CO, 10A, 110V DC, LED+Test Butonlu Röle / Test Button Plug-In Industrial Relay	20
8036322040	TRB LT-2C-10A-24 V AC	2CO, 10A, 24V AC, LED+Test Butonlu Röle / Test Button Plug-In Industrial Relay	20
8036322050	TRB LT-2C-10A-48 V AC	2CO, 10A, 48V AC, LED+Test Butonlu Röle / Test Button Plug-In Industrial Relay	20
8036322060	TRB LT-2C-10A-115 V AC	2CO, 10A, 115V AC, LED+Test Butonlu Röle / Test Button Plug-In Industrial Relay	20
8036322070	TRB LT-2C-10A-230 V AC	2CO, 10A, 230V AC, LED+Test Butonlu Röle / Test Button Plug-In Industrial Relay	20

**4CO 5A Kalın Tip Endüstriyel Röle
Plug-In Industrial Relay**



Ürün Kodu Product Code	Ürün Adı Product Name	Açıklama Explanation	Amb. Mik. Pack. Qty (Adet/Pcs.)
8036324500	TRB LT-4C-5A-12 V DC	4CO, 5A, 12V DC, LED+Test Butonlu Röle / Test Button Plug-In Industrial Relay	20
8036324510	TRB LT-4C-5A-24 V DC	4CO, 5A, 24V DC, LED+Test Butonlu Röle / Test Button Plug-In Industrial Relay	20
8036324520	TRB LT-4C-5A-48 V DC	4CO, 5A, 48V DC, LED+Test Butonlu Röle / Test Button Plug-In Industrial Relay	20
8036324530	TRB LT-4C-5A-110 V DC	4CO, 5A, 110V DC, LED+Test Butonlu Röle / Test Button Plug-In Industrial Relay	20
8036324540	TRB LT-4C-5A-24 V AC	4CO, 5A, 24V AC, LED+Test Butonlu Röle / Test Button Plug-In Industrial Relay	20
8036324550	TRB LT-4C-5A-48 V AC	4CO, 5A, 48V AC, LED+Test Butonlu Röle / Test Button Plug-In Industrial Relay	20
8036324560	TRB LT-4C-5A-115 V AC	4CO, 5A, 110V AC, LED+Test Butonlu Röle / Test Button Plug-In Industrial Relay	20
8036324570	TRB LT-4C-5A-230 V AC	4CO, 5A, 220V AC, LED+Test Butonlu Röle / Test Button Plug-In Industrial Relay	20

Aksesuarlar Accessories



Ürün Kodu Product Code	Ürün Adı Product Name	Açıklama Explanation	Amb. Mik. Pack. Qty (Adet/Pcs.)
8036024002	TS-V TRB 4C	2 & 4 Kontaklı Vidalı Röle Soketi / 2C & 4C Screw Relay Socket	10
8036224000	TS-P TRB 2C	2 Kontaklı Push-In Röle Soketi / 2C Push-In Relay Socket	10
8036224002	TS-P TRB 4C	4 Kontaklı Push-In Röle Soketi / 4C Push-In Relay Socket	10
8036330101	MARK- TRB	Etiket (Röle ile birlikte set olarak verilmektedir) / Marking Tag(Arriving as set with relay)	50
8036330060	LED FC R 6-24 VAC/DC	Harici Led Modülü / External Led Modul	5
8036330001	CP- TRB	Plastik Röle Tutucu / Plastic Relay Holder	20
8036331005	JP TS-P-4C-5	TRB Serisi için 5 Kutuplu Köprü / 5 pole jumper for TRS Series	5

Vida Bağlantılı 1CO PLC Röleler Screw Type 1CO PLC Relays

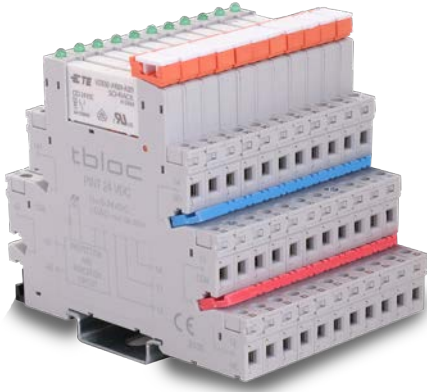

Ürün Kodu Product Code	Ürün Adı Product Name	Açıklama Explanation	Amb. Mik. Pack. Qty (Adet/Pcs.)
8031241500	PINT-1C 24 V DC - 6A	1CO, 24 V DC PLC Röle + Soket / Relay and Socket	20
8031241502	PINT-1C 12 VAC/DC - 6A	1CO, 12 VAC/DC Röle + Soket / Relay and Socket	20
8031241510	PINT-1C 24 VAC/DC - 6A	1CO, 24 VAC/DC Röle + Soket / Relay and Socket	20
8031241503	PINT-1C 48 VAC/DC - 6A	1CO, 48 VAC/DC Röle + Soket / Relay and Socket	20
8031241511	PINT-1C 60 VAC/DC - 6A	1CO, 60 VAC/DC Röle + Soket / Relay and Socket	20
8031241512	PINT-1C 110 VAC/DC - 6A	1CO, 110 VAC/DC Röle + Soket / Relay and Socket	20
8031241513	PINT-1C 230 VAC/DC - 6A	1CO, 230 VAC/DC Röle + Soket / Relay and Socket	20

Vida Bağlantılı 2CO PLC Röleler Screw Type 2CO PLC Relays



Ürün Kodu Product Code	Ürün Adı Product Name	Açıklama Explanation	Amb. Mik. Pack. Qty (Adet/Pcs.)
8031241540	PINT-2C 24 V DC - 8A	2CO, 24 V DC PLC Röle + Soket / Relay and Socket	20
8031241541	PINT-2C 24 V AC/DC - 8A	2CO, 24 V AC/DC Röle + Soket / Relay and Socket	20
8031241542	PINT-2C 48 V AC/DC - 8A	2CO, 48 V AC/DC Röle + Soket / Relay and Socket	20
8031241543	PINT-2C 110 V AC/DC - 8A	2CO, 110 V AC/DC Röle + Soket / Relay and Socket	20
8031241544	PINT-2C 230 V AC/DC - 8A	2CO, 230 V AC/DC Röle + Soket / Relay and Socket	20

Aksesuarlar Accessories



Ürün Kodu Product Code	Ürün Adı Product Name	Açıklama Explanation	Amb. Mik. Pack. Qty (Adet/Pcs.)
8031241533	PINT GİRİŞ ADAPTÖRÜ	PINT 1C Serisi PLC Röle Adaptör / Adaptor for PINT 1C PLC Relays	20

Aksesuarlar Accessories

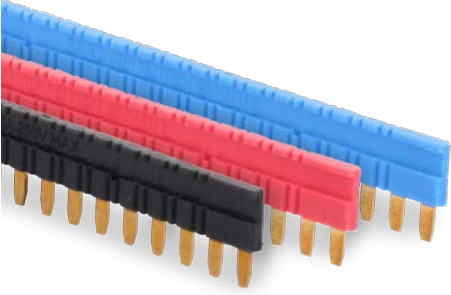

Ürün Kodu Product Code	Ürün Adı Product Name	Açıklama Explanation	Amb. Mik. Pack. Qty (Adet/Pcs.)
8036331000	JP PINT-20-MAVİ	PINT 1C Serisi için 20 Kutuplu Köprü / 20 Pole jumper for PINT 1C (Blue)	5
8036331001	JP PINT-20-SİYAH	PINT 1C Serisi için 20 Kutuplu Köprü / 20 Pole jumper for PINT 1C (Black)	5
8036331002	JP PINT-20-KIRMIZI	PINT 1C Serisi için 20 Kutuplu Köprü / 20 Pole jumper for PINT 1C (Red)	5

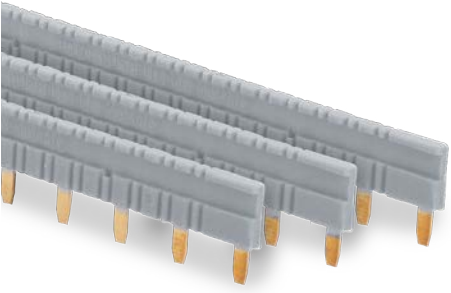

Ürün Kodu Product Code	Ürün Adı Product Name	Açıklama Explanation	Amb. Mik. Pack. Qty (Adet/Pcs.)
8036331007	JP PINT-8-GRİ	PINT 2C Serisi için 8 Kutuplu Köprü / 8 Pole jumper for PINT 2C (Gray)	5

tbloc
Electrical & Electronic Manufacturing

MERKEZ / HEADQUARTER

**Tbloc Elektrik Elektronik
Sanayi ve Ticaret A.Ş.**

29 Ekim Mahallesi
10001 Sokak No: 50/4
35663 Menemen İzmir Türkiye
Tel: +90 232 833 26 96
Fax: +90 232 833 26 97

info@tbloc.com.tr
www.tbloc.com.tr

