

# tbloc

## 2024

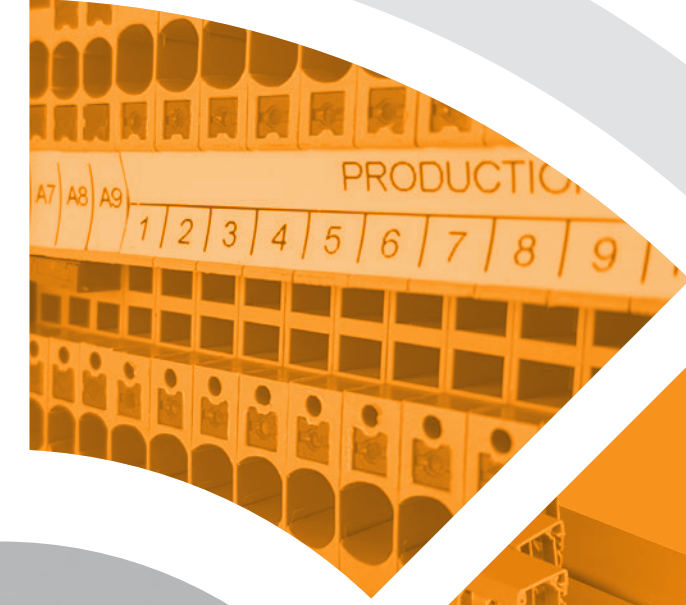

**Ürün Kataloğu**  
Product Catalog



## İçindekiler

### Index

<b>NTB Kompakt Vida Bağlantılı Ray Klemensleri</b>	NTB Compact Screw Type Terminal Blocks	06 - 13
<b>Vida Bağlantılı Ray Klemensleri</b>	Screw Type Terminal Blocks	14 - 39
<b>Push-in Klemensleri</b>	Push-in Terminal Blocks	40 - 51
<b>Sıra Klemensleri ve Durdurucular</b>	Terminal Strips and End Bracket	52
<b>Grup Etiketleri ve Etiket Şemsiyesi</b>	Group Marker and Marker Holder	53
<b>Nihayet Plakaları ve Ayırma Plakaları</b>	End Plates and Partition Plates	54 - 55
<b>Test Fişleri ve Tarak Köprüler</b>	Test Sockets and Comb Connector	56
<b>Vidalı Üst Köprüler</b>	Cross Connections	57
<b>Push-in Üst Köprüler ve Kayar Köprüler</b>	Push-in Cross Connections and Sliding Connector	58
<b>Klemens Etiketleri</b>	Marking Tags	59 - 62
<b>Montaj Rayları</b>	Mounting Rails	63
<b>Kanal ve Ray Kesme Makası</b>	Wiring Duct and Din Rail Cutter	64
<b>Pano Tipi Delikli Kablo Kanalları</b>	Panel Type Slotted Wiring Ducts	65 - 66
<b>Markalama Sistemleri</b>	Marking Systems	67 - 73
<b>Paslanmaz Çelik Kablo Bağları - 304 Kalite</b>	Stainless Steel Cable Ties - Grade 304	74
<b>Müşterek w otomat baraları</b>	Pin mcb busbars	75
<b>Plastik Kablo Bağları</b>	Plastic Cable Ties	76
<b>Kroşeler ve Kablo Bağ Sıkma ve Kesme Aleti</b>	Tie Mounts and Cable Tie Tightening and Cutting Tool	77
<b>Plastik Kablo Etiketleri</b>	Plastic Cable Label	79 - 81
<b>Kablo Pabuçları ve Ek Muflar</b>	Cable Lugs and Butt Terminals	82 - 88
<b>Kablo Yüksükleri</b>	End Sleeves	90 - 92
<b>Sinyal Lambaları ve Butonlar</b>	Led Indicators and Buttons	93 - 99
<b>Endüstriyel ve PLC Röleler</b>	Industrial and Interface Relays	101 - 106

**TBLOC 2020 yılının Ocak ayında İzmir’de kurulmuş bir endüstri firmasıdır. Yeni bir firma olmasına rağmen kökleri uzun yıllara dayanan tecrübe ve birikimler nedeniyle çok derindedir. TBLOC, Türkiye’nin yeni bağlantı elemanları markası olarak Ar-Ge, Üretim ve Satış faaliyetlerini tek çatı altında yürütmekte ve bir Türk markası olarak uluslararası standartlarda ürettiği ürünleri tüm dünyaya ihraç etmektedir.**

**TBLOC markası, klemensin İngilizce karşılığı olan Terminal Block kelimelerinin bir kısaltması olarak görünse de “t” harfi teknolojinin kısaltması olarak markamızın başında, şirketimizin uzun vadeli planlarının göstergesi olarak yerini almıştır.**

## **Tbloc Kurumsal**



TBLOC is an industrial company established in January 2020 in İzmir/Turkey. Even though TBLOC is a new company, it has deep roots backed up with long years experience and knowledge. TBLOC, as a new brand in connectivity industry, is gathering all R&D, production and sales & marketing functions under one roof with the aim of becoming a global brand and supplying to international markets.

Despite TBLOC brand is being perceived as an abbreviation of Terminal Block definition, first letter “t” stands for technology and indicates our company’s long term vision.

Tbloc Corporate

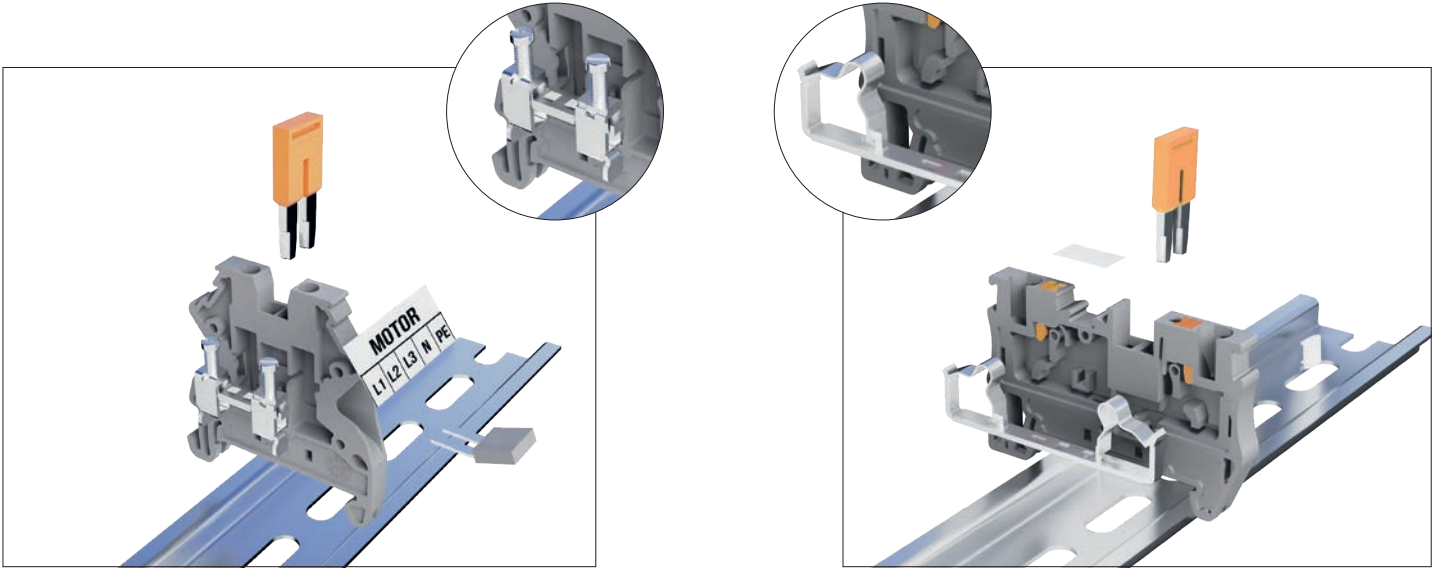

### Vida Bağlantısı

Vidalı bağlantı bilinen en klasik bağlantı yöntemidir. Isıl işlem ile güçlendirilmiş sac ayaklar sayesinde uzun dönemde güvenli ve dayanıklı saha kullanımı mümkündür.

### Güvenilir Bağlantı Ünitesi

Vidalı klemenslerde yer alan bağlantı ünitesi de (klemens ayağı), vidalarda olduğu gibi güçlendirilmiş çelikten üretilmektedir. Vida sıkıldığında bağlantı ünitesinde meydana gelen kuvvet bir kilitleme mekanizması oluşturur. Bu sistem sayesinde, uzun ömürlü ve güvenli bağlantı elde edilmektedir.

### Push-in Bağlantı

Tbloc push-in klemensler, herhangi bir alet kullanmaksızın kolay ve hızlı montaj avantajı sağlamaktadır. Bu bağlantı teknolojisi sayesinde; tek damarlı kablolar ön hazırlığa gerek duymaksızın, çok damarlı kablolar da yüksek olarak kolayca montajlanabilir. Ayrıca klemens üzerinde yer alan kırmızı butonlar, kullanıcıya klemensin iletken kısımlarına temas etmeden demontaj avantajı sağlamaktadır. Push-in bağlantılı klemensler titreşime karşı dayanıklıdır.

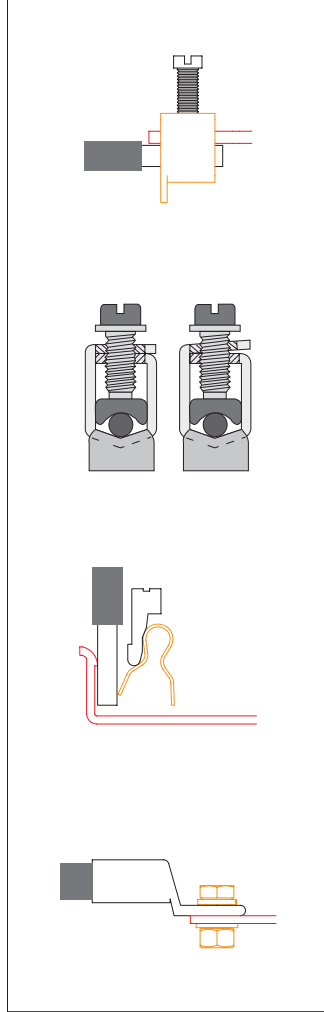

### Screw Connection

Screw type connection is the classical method for terminal blocks. Reinforced clamps ensures the safe and durable connection for long time of usage.

### Reliable Clamping

The connection unit (yokes) in the terminal block is made of reinforced steel, as in the screw. When the screw is tightened, the force that occurs in the connection unit creates a locking mechanism. Thanks to that, durable and safe connection is obtained.

### Push-in Connection

Tbloc push-in terminal blocks provide fast assembly of cables without using a tool. With this technology, solid conductors (just stripping is enough) and flexible conductors (with end ferrules) can be assembled easily. Red buttons on top of the terminal blocks provide easy disassembly without touching conductive parts of the terminal blocks. Push-in connection is resistant to vibration hence can be used safely in many areas.



# NTB

Geçiş Klemensleri  
Çok Katlı Klemensler  
Sigortalı ve Ayırmalı Klemensler  
Topraklama Klemensleri

**Kompakt Tasarım**  
**11.4 mm Şerit Etiket**  
**Pratik Üst Köprü**

# NTB

Feed Through Terminal Blocks  
Multi Level Terminal Blocks  
Fuse and Disconnect Terminal Blocks  
Earth Terminal Blocks

**Compact Desing**  
**11.4 mm Strip Label**  
**Plug -In Cross Connection**

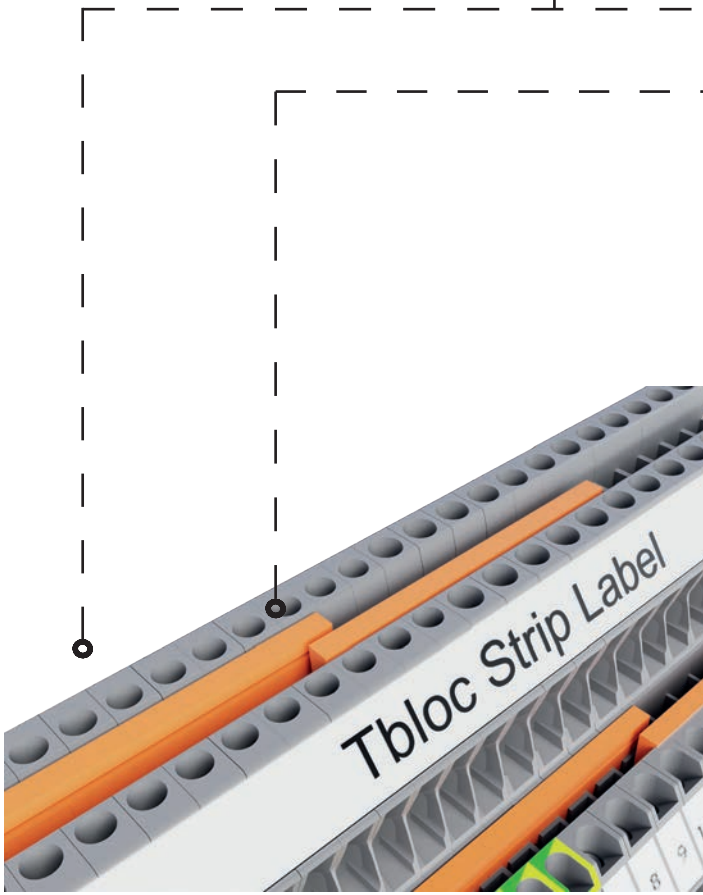

- Kompakt Tasarım
- **Compact Desing**

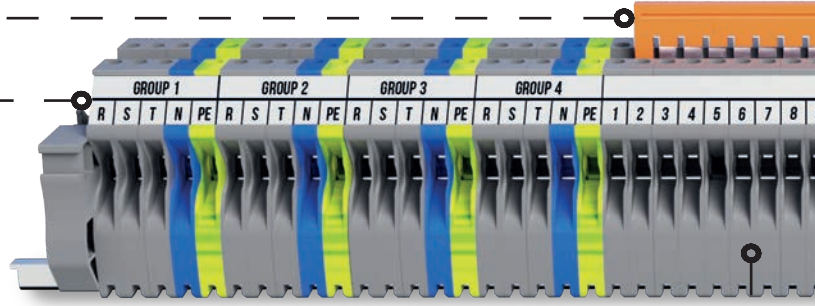

- Pratik Üst Köprü
- 11.4 mm Şerit Etiket
- **Plug -In Cross Connection**
- **11.4 mm Strip Label**

Genişlik / Width : 5,2 mm

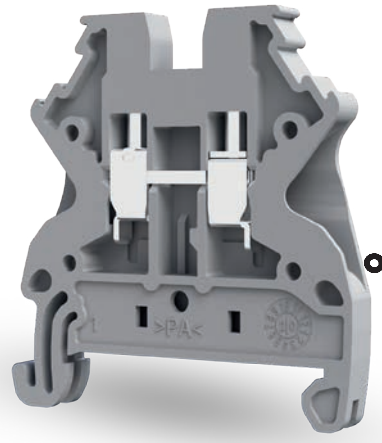





EAC

YENİ ÜRÜN  
NEW PRODUCT

2024

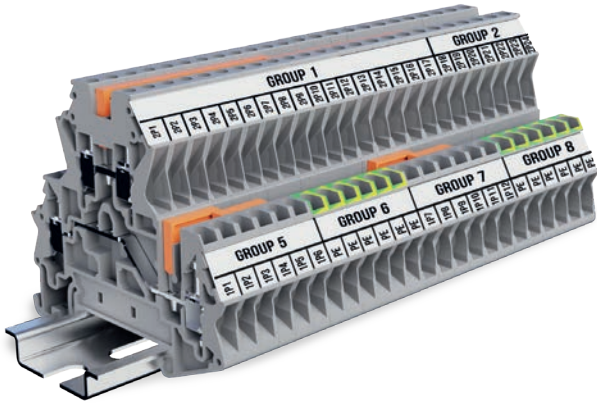
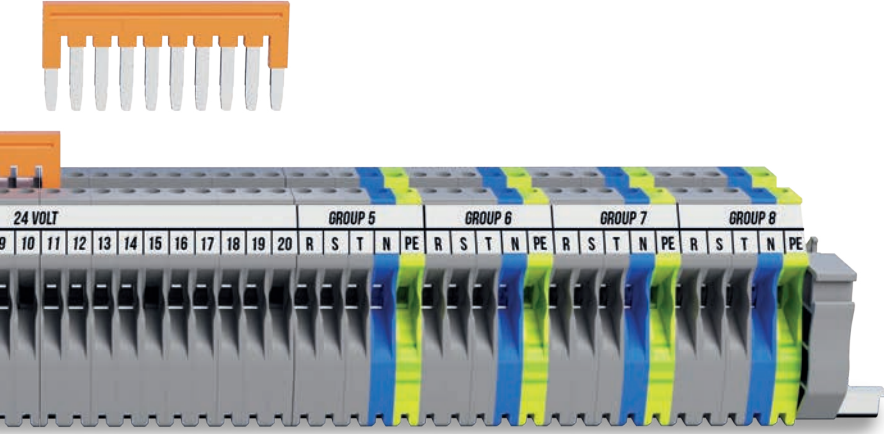

- Çok Katlı Klemensler
- Multi Level Terminal Blocks

- Sigortalı ve Ayırmalı Klemensler
- Fuse and Disconnect Terminal Blocks

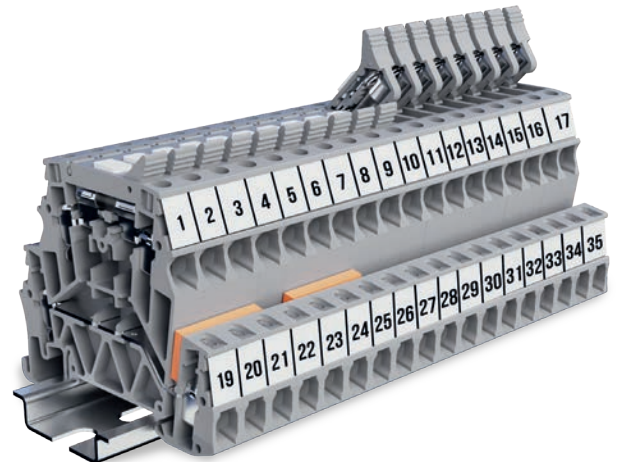

## Vida Bağlantılı Ray Klemensleri Screw Type Terminal Blocks

### NTB Serisi Geçiş Klemensleri

NTB Series Feed Through Terminal Block



NTB 2,5

YENİ  
NEW

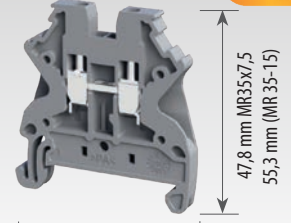

45,2 mm

Genişlik / Width : 5,2 mm



Ürün Adı / Product Name

NTB 2,5

Sipariş No / Order No.

8000099208

Paket Adeti / Packing Qty.

100

Anma Değerleri / Rated Values

IEC 60947-7-1

800 V / 24 A

Bağlantı Bilgileri / Connection Information

Kesit / Cross-Section (mm<sup>2</sup>)

2,5

Tek Damarlı Kablo / Solid Conductor Cross-Section min-max mm<sup>2</sup>

0,5 - 4

Çok Damarlı Kablo / Stranded Conductor Cross-Section min-max mm<sup>2</sup>

0,5 - 4

Çok Telli Kablo / Flexible Conductor Cross-Section min-max mm<sup>2</sup>

0,5 - 2,5

AWG

20-12 AWG

Açıklamalar / Descriptions

Kablo Soyma Uzunluğu / Insulation Stripping Length (mm)

10

Max. Sıkma Torku (N.m) / Max. Tightening Torque

0,6

Bağlantı Vidası / Screw Diameter

M2,5

Darbe Gerilimi / Rated Impulse Voltage (Kv)

6

Kirlilik Derecesi / Gerilim Kategorisi / Malzeme Grubu / Pollution Degree / Voltage Category / Material Group

3 / III / I

Aksesuarlar / Accessories

Montaj Rayı / Din Rail

Ürün Adı Product Name	Sipariş No Order No.	Adet Qty.
DR 35-7,5 S 2M	8015393407	40
DR 35-15 S 2M	8015393427	20
SS 1	8010097308	50
SS 2	8010097318	50
PS 1	8010197328	50
PS 2	8010197420	50
PCC 2,5/2	8013294523	100
PCC 2,5/3	8013294533	100
PCC 2,5/10	8013294503	10
TCC 2,5/2	8013094223	50
TCC 2,5/3	8013094203	50
TCC 2,5/10	8013094233	10
EPL NTB 2,5-10	8012396288	50
MTG 5	8020389009	500
TBSL 22x20	8020384009	1
GM1	8014393008	50
GM2	8014393018	50
TM1	8014393020	50
1,0x5,5		

Durdurucu / End Stopper

Üst Köprü / Cross Connection

Tarak Köprü / Comb Connector

Nihayet Plakası / End Plate

Klemens Etiketi / Marking Tags

Şerit Etiket / Strip Label

Grup Etiketi / Group Label

Tornavida / Screwdriver

\* TM1 Sadece PS2 ürünü ile Uyumludur.

\* TM1 is only suitable for PS2

Renk Kodları / Color Codes

800009900....

...0

...1

...2

...3

...4

...5

...6

...9

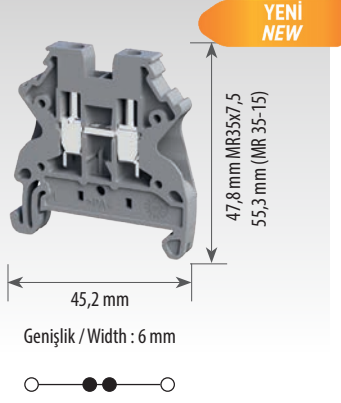
**NTB 4****NTB 4**

8000099308

85

800 V / 32 A

4

0,5 - 6

0,5 - 6

0,5 - 4

20-10 AWG

10

0,8

M3

6

3 / III / I

**NTB 6****NTB 6**

8000099408

65

800 V / 41 A

6

0,5 - 10

0,5 - 10

0,5 - 6

20-8 AWG

10

1,2

M3,5

8

3 / III / I

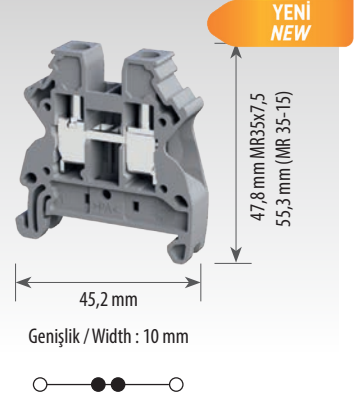
**NTB 10****NTB 10**

8000099508

50

800 V / 57 A

10

1,5 - 16

1,5 - 16

1,5 - 10

20-6 AWG

10

1,5

M4

8

3 / III / I

Ürün Adı Product Name	Sipariş No Order No.	Adet Qty.
DR 35-7,5 S 2M	8015393407	40
DR 35-15 S 2M	8015393427	20
SS 1	8010097308	50
SS 2	8010097318	50
PS 1	8010197328	50
PS 2	8010197420	50
PCC 4/2	8013294623	100
PCC 4/3	8013294633	100
PCC 4/10	8013294603	10
TCC 4/2	8013094323	50
TCC 4/3	8013094333	50
TCC 4/10	8013094303	10
EPL NTB 2,5-10	8012396288	50
MTG 6	8020388009	500
TBSL 22x20	8020384009	1
GM1	8014393008	50
GM2	8014393018	50
TM1	8014393020	50
1,0x5,5		

Ürün Adı Product Name	Sipariş No Order No.	Adet Qty.
DR 35-7,5 S 2M	8015393407	40
DR 35-15 S 2M	8015393427	20
SS 1	8010097308	50
SS 2	8010097318	50
PS 1	8010197328	50
PS 2	8010197420	50
PCC 6/2	8013294723	50
PCC 6/3	8013294733	50
PCC 6/10-T	8013295703	10
EPL NTB 2,5-10	8012396288	50
MTG 8	8020386009	500
TBSL 22x20	8020384009	1
GM1	8014393008	50
GM2	8014393018	50
TM1	8014393020	50
1,0x5,5		

Ürün Adı Product Name	Sipariş No Order No.	Adet Qty.
DR 35-7,5 S 2M	8015393407	40
DR 35-15 S 2M	8015393427	20
SS 1	8010097308	50
SS 2	8010097318	50
PS 1	8010197328	50
PS 2	8010197420	50
PCC 10/2	8013294823	10
EPL NTB 2,5-10	8012396288	50
MTG 10	8020385009	250
TBSL 22x20	8020384009	1
GM1	8014393008	50
GM2	8014393018	50
TM1	8014393020	50
1,0x5,5		

\* TM1 Sadece PS2 ürünü ile Uyumludur.

\* TM1 is only suitable for PS2

## Vida Bağlantılı Ray Klemensleri Screw Type Terminal Blocks

### NTB Serisi Çok Katlı Klemensler NTB Series Multi Levels Terminal Blocks



## NTB 2,5 2P

YENİ  
NEW

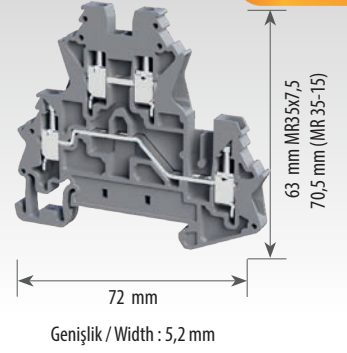

Ürün Adı / Product Name

**NTB 2,5 2P**

Sipariş No / Order No.

8002099558

Paket Adeti / Packing Qty.

Anma Değerleri / Rated Values

IEC 60947-7-1

500 V / 24 A

Bağlantı Bilgileri / Connection Information

Kesit / Cross-Section (mm<sup>2</sup>)

2,5

Tek Damarlı Kablo / Solid Conductor Cross-Section min-max mm<sup>2</sup>

0,5 - 4

Çok Damarlı Kablo / Stranded Conductor Cross-Section min-max mm<sup>2</sup>

0,5 - 4

Çok Tellî Kablo / Flexible Conductor Cross-Section min-max mm<sup>2</sup>

0,5 - 2,5

AWG

20-12 AWG

Açıklamalar / Descriptions

Kablo Soyma Uzunluğu / Insulation Stripping Length (mm)

10

Max. Sıkma Torku (N.m) / Max. Tightening Torque

0,6

Bağlantı Vidası / Screw Diameter

M2,5

Darbe Gerilimi / Rated Impulse Voltage (Kv)

6

Kirlilik Derecesi / Gerilim Kategorisi / Malzeme Grubu / Pollution Degree / Voltage Category / Material Group

3 / III / I

Aksesuarlar / Accessories

Montaj Rayı / Din Rail

Ürün Adı Product Name	Sipariş No Order No.	Adet Qty.
DR 35-7,5 S 2M	8015393407	40
DR 35-15 S 2M	8015393427	20
SS 1	8010097308	50
SS 2	8010097318	50
PS 1	8010197328	50
PS 2	8010197420	50
PCC 2,5/2	8013294523	100
PCC 2,5/3	8013294533	100
PCC 2,5/10	8013294503	10
EPL NTB 2,5-4 2P	8012396388	20
TBSL 22x20	8020384009	1
MTG 5	8020389009	500
GM1	8014393008	50
GM2	8014393018	50
TM1	8014393020	50
1,0x5,5		

Durdurucu / End Stopper

Üst Köprü / Cross Connection

Nihayet Plakası / End Plate

Şerit Etiket / Strip Label

Klemens Etiketi / Marking Tags

Grup Etiketi / Group Label

Tornavida / Screwdriver

\* TM1 Sadece PS2 ürünü ile Uyumludur.

\* TM1 is only suitable for PS2

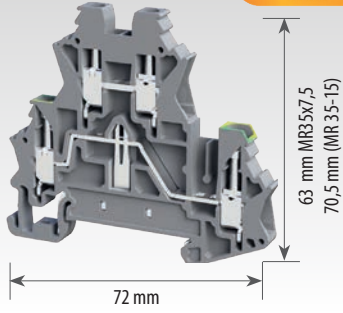
**NTB 2,5 P + E****YENİ  
NEW**

Genişlik / Width : 5,2 mm

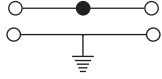
**NTB 2,5 P + E**

8002099568

500 V / 24 A

2,5

0,5 - 4

0,5 - 4

0,5 - 2,5

20-12 AWG

12

0,8

M3

6

3 / III / I

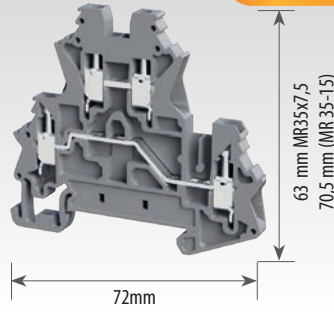
**NTB 4 2P****YENİ  
NEW**

Genişlik / Width : 6 mm

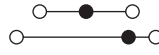
**NTB 4 2P**

8002099658

500 V / 32 A

4

0,5 - 6

0,5 - 6

0,5 - 4

20-10 AWG

12

0,8

M3

6

3 / III / I

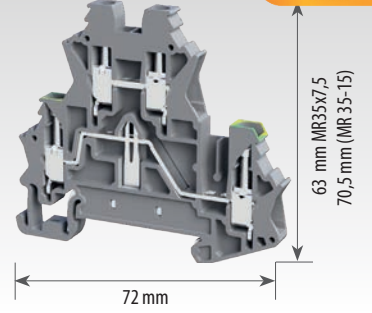
**NTB 4 P + E****YENİ  
NEW**

Genişlik / Width : 6 mm

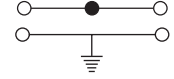
**NTB 4 P + E**

8002099668

500 V / 32 A

4

0,5 - 6

0,5 - 6

0,5 - 4

20-10 AWG

12

0,8

M3

6

3 / III / I

Ürün Adı Product Name	Sipariş No Order No.	Adet Qty.
DR 35-7,5 S 2M	8015393407	40
DR 35-15 S 2M	8015393427	20
SS 1	8010097308	50
SS 2	8010097318	50
PS 1	8010197328	50
PS 2	8010197420	50
PCC 2,5/2	8013294523	100
PCC 2,5/3	8013294533	100
PCC 2,5/10	8013294503	10
EPL NTB 2,5-4 2P	8012396388	20
TBSL 22x20	8020384009	1
MTG 5	8020389009	500
GM1	8014393008	50
GM2	8014393018	50
TM1	8014393020	50
1,0x5,5	8014393018	50

**\* TM1 Sadece PS2 ürünü ile Uyumludur.**

\* TM1 is only suitable for PS2

Ürün Adı Product Name	Sipariş No Order No.	Adet Qty.
DR 35-7,5 S 2M	8015393407	40
DR 35-15 S 2M	8015393427	20
SS 1	8010097308	50
SS 2	8010097318	50
PS 1	8010197328	50
PS 2	8010197420	50
PCC 4/2	8013294623	100
PCC 4/3	8013294633	100
PCC 4/10	8013294603	10
EPL NTB 2,5-4 2P	8012396388	20
TBSL 22x20	8020384009	1
MTG 6	8020388009	500
GM1	8014393008	50
GM2	8014393018	50
TM1	8014393020	50
1,0x5,5		

Ürün Adı Product Name	Sipariş No Order No.	Adet Qty.
DR 35-7,5 S 2M	8015393407	40
DR 35-15 S 2M	8015393427	20
SS 1	8010097308	50
SS 2	8010097318	50
PS 1	8010197328	50
PS 2	8010197420	50
PCC 4/2	8013294623	100
PCC 4/3	8013294633	100
PCC 4/10	8013294603	10
EPL NTB 2,5-4 2P	8012396388	20
TBSL 22x20	8020384009	1
MTG 6	8020388009	500
GM1	8014393008	50
GM2	8014393018	50
TM1	8014393020	50
1,0x5,5	8014393018	50

## Vida Bağlantılı Ray Klemensleri Screw Type Terminal Blocks

### NTB Serisi Topraklama Klemensleri NTB Series Earth Terminal Blocks



## NTB 2,5 E

YENİ  
NEW

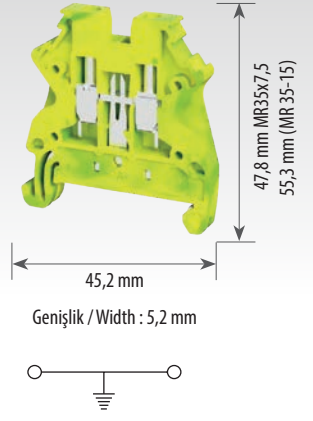

<b>Ürün Adı / Product Name</b>	<b>NTB 2,5 E</b>		
<b>Sipariş No / Order No.</b>	8001099304		
<b>Paket Adeti / Packing Qty.</b>	70		
<b>Anma Değerleri / Rated Values</b>	-		
<b>Bağlantı Bilgileri / Connection Information</b>			
<b>Kesit / Cross-Section (mm<sup>2</sup>)</b>	2,5		
<b>Tek Damarlı Kablo / Solid Conductor Cross-Section min-max mm<sup>2</sup></b>	0,5 - 4		
<b>Çok Damarlı Kablo / Stranded Conductor Cross-Section min-max mm<sup>2</sup></b>	0,5 - 4		
<b>Çok Tellli Kablo / Flexible Conductor Cross-Section min-max mm<sup>2</sup></b>	0,5 - 2,5		
<b>AWG</b>	20-12 AWG		
<b>Açıklamalar / Descriptions</b>			
<b>Kablo Soyma Uzunluğu / Insulation Stripping Length (mm)</b>	12		
<b>Max. Sıkma Torku (N.m) / Max. Tightening Torque</b>	0,6		
<b>Bağlantı Vidası / Screw Diameter</b>	M2,5		
<b>Darbe Gerilimi / Rated Impulse Voltage (Kv)</b>	6		
<b>Kirlilik Derecesi / Gerilim Kategorisi / Malzeme Grubu / Pollution Degree / Voltage Category / Material Group</b>	3 / III / I		
<b>Aksesuarlar / Accessories</b>	<b>Ürün Adı / Product Name</b>	<b>Sipariş No / Order No.</b>	<b>Adet Qty.</b>
<b>Montaj Rayı / Din Rail</b>	DR 35-7,5 S 2M	8015393407	40
	DR 35-15 S 2M	8015393427	20
<b>Durdurucu / End Stopper</b>	SS 1	8010097308	50
	SS 2	8010097318	50
	PS 1	8010197328	50
	PS 2	8010197420	50
<b>Nihayet Plakası / End Plate</b>	EPL NTB 2,5-10 E	8012396284	50
<b>Şerit Etiket / Strip Label</b>	TBSL 22x20	8020384009	1
<b>Klemens Etiketi / Marking Tags</b>	MTG 5	8020389009	500
	GM1	8014393008	50
<b>Grup Etiketi / Group Label</b>	GM2	8014393018	50
	TM1	8014393020	50
<b>Tornavida / Screwdriver</b>	1,0x5,5		

\* TM1 Sadece PS2 ürünü ile Uyumludur.

\* TM1 is only suitable for PS2

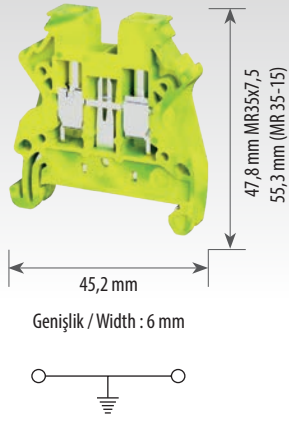
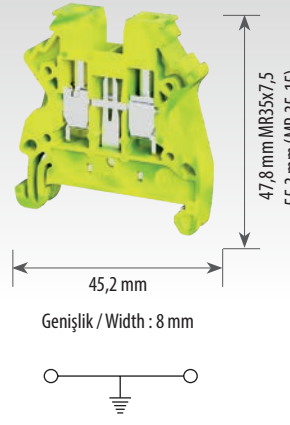
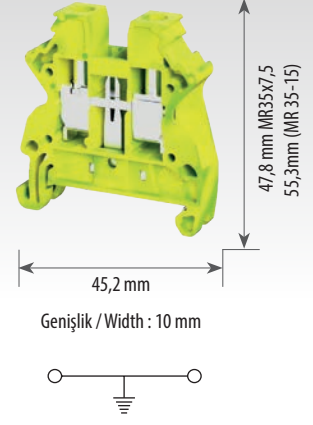
**NTB 4 E****YENİ  
NEW****NTB 6 E****YENİ  
NEW****NTB 10 E****YENİ  
NEW****NTB 4 E**

8001099314

60

4

0,5 - 6

0,5 - 6

0,5 - 4

20-10 AWG

12

0,8

M3

6

3 / III / I

**NTB 6 E**

8001099324

45

6

1,5 - 6

1,5 - 6

1,5 - 6

20-8 AWG

12

1,2

M3,5

8

3 / III / I

**NTB 10 E**

8001099334

35

10

1,5 - 10

1,5 - 10

1,5 - 10

20-6 AWG

12

1,5

M4

8

3 / III / I

Ürün Adı Product Name	Sipariş No Order No.	Adet Qty.
DR 35-7,5 S 2M	8015393407	40
DR 35-15 S 2M	8015393427	20
SS 1	8010097308	50
SS 2	8010097318	50
PS 1	8010197328	50
PS 2	8010197420	50
EPL NTB 2,5-10 E	8012396284	50
TBSL 22x20	8020384009	1
MTG 6	8020388009	500
GM1	8014393008	50
GM2	8014393018	50
TM1	8014393020	50
1,0x5,5		

Ürün Adı Product Name	Sipariş No Order No.	Adet Qty.
DR 35-7,5 S 2M	8015393407	40
DR 35-15 S 2M	8015393427	20
SS 1	8010097308	50
SS 2	8010097318	50
PS 1	8010197328	50
PS 2	8010197420	50
EPL NTB 2,5-10 E	8012396284	50
TBSL 22x20	8020384009	1
MTG 8	8020386009	500
GM1	8014393008	50
GM2	8014393018	50
TM1	8014393020	50
1,0x5,5	8014393018	50

Ürün Adı Product Name	Sipariş No Order No.	Adet Qty.
DR 35-7,5 S 2M	8015393407	40
DR 35-15 S 2M	8015393427	20
SS 1	8010097308	50
SS 2	8010097318	50
PS 1	8010197328	50
PS 2	8010197420	50
EPL NTB 2,5-10 E	8012396284	50
TBSL 22x20	8020384009	1
MTG 10	8020385009	250
GM1	8014393008	50
GM2	8014393018	50
TM1	8014393020	50
1,0x5,5	8014393018	50

\* TM1 Sadece PS2 ürünü ile Uyumludur.

\* TM1 is only suitable for PS2

## Vida Bağlantılı Ray Klemensleri Screw Type Terminal Blocks

### TBL Serisi Geçiş Klemensleri

TBL Series Feed Through Terminal Block



Ürün Adı / Product Name

Sipariş No / Order No.

Paket Adeti / Packing Qty.

Anma Değerleri / Rated Values

IEC 60947-7-1

Bağlantı Bilgileri / Connection Information

Kesit / Cross-Section (mm<sup>2</sup>)

Tek Damarlı Kablo / Solid Conductor Cross-Section min mm<sup>2</sup>: (mm<sup>2</sup>)-(min-max)

Çok Damarlı Kablo / Stranded Conductor Cross-Section (mm<sup>2</sup>)-(min-max)

Çok Telli Kablo / Flexible Conductor Cross-Section (mm<sup>2</sup>)-(min-max)

AWG

Açıklamalar / Descriptions

Kablo Soyma Uzunluğu / Insulation Stripping Length (mm)

Max. Sıkma Torku (N.m) / Max. Tightening Torque

Bağlantı Vidası / Screw Diameter

Darbe Gerilimi / Rated Impulse Voltage (Kv)

Kirlilik Derecesi / Gerilim Kategorisi / Malzeme Grubu / Pollution Degree / Voltage Category / Material Group

Aksesuarlar / Accessories

Montaj Rayı / Din Rail

Durdurucu / End Stopper

Nihayet Plakası / End Plate

Ayırma Plakası / Partition Plate

Mini Ayırma Dili / Small Partition Plate

Üst Köprü / Cross Connection

Tarak Köprü / Comb Connector

Test Fişi / Test Plug

Klemens Etiketi / Marking Tags

Şerit Etiket / Strip Label

Grup Etiketi / Group Label

Tornavida / Screwdriver

Renk Kodları / Color Codes

800009900....

...0

...1

...2

...3

...4

...5

...6

...9

## TBL 2,5

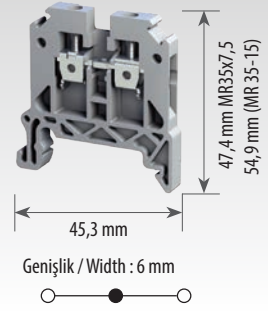

## TBL 2,5

8000099008

100

500 V / 24 A

2,5

0,5 -4

0,5 -4

0,5 -2,5

20-12 AWG

10

0,6

M2,5

6

3 / III / I

Ürün Adı Product Name	Sipariş No Order No.	Adet Qty.
DR 35-7,5 S 2M	8015393407	40
DR 35-15 S 2M	8015393427	20
SS 1	8010097308	50
SS 2	8010097318	50
PS 1	8010197328	50
PS 2	8010197420	50
EPL TBL 2,5-10	8012396118	50
PR TBL 2,5-10	8012396408	100
SPR 2,5-10	8012396528	100
SCC 2,5/2	8013095023	50
SCC 2,5/3	8013095033	50
SCC 2,5/10	8013095003	10
TCC 2,5/2	8013094223	50
TCC 2,5/3	8013094203	50
TCC 2,5/10	8013094233	10
TST 1	8014393227	50
MTG 6	8020388009	500
TBSL 5,15x5	8020384011	1
GM1	8014393008	50
GM2	8014393018	50
TM1	8014393020	50
0,5x3,0		

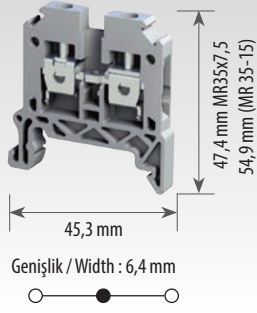

**TBL 4****TBL 4**

8000099028

100

800 V / 32 A

4

0,5 - 6

0,5 - 6

0,5 - 4

20-10 AWG

12

0,8

M3

6

3 / III / I

Ürün Adı Product Name	Sipariş No Order No.	Adet Qty.
DR 35-7,5 S 2M	8015393407	40
DR 35-15 S 2M	8015393427	20
SS 1	8010097308	50
SS 2	8010097318	50
PS 1	8010197328	50
PS 2	8010197420	50
EPL TBL 2,5-10	8012396118	50
PR TBL 2,5 - 10	8012396408	50
SPR 2,5-10	8012396528	100
SCC 4/2	8013095123	50
SCC 4/3	8013095133	50
SCC 4/10	8013095103	10
TCC 4/2	8013094323	50
TCC 4/3	8013094333	50
TCC 4/10	8013094303	10
TST 1	8014393227	50
MTG 6,4	8020387009	500
TBSL 5,15x5	8020384011	1
GM1	8014393008	50
GM2	8014393018	50
TM1	8014393020	50
0,5x3,0		

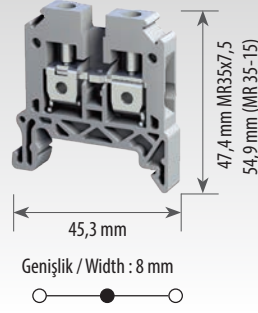
**TBL 6****TBL 6**

8000099038

80

800 V / 41 A

6

0,5 - 10

0,5 - 10

0,5 - 6

20-8 AWG

12

1,2

M3,5

8

3 / III / I

Ürün Adı Product Name	Sipariş No Order No.	Adet Qty.
DR 35-7,5 S 2M	8015393407	40
DR 35-15 S 2M	8015393427	20
SS 1	8010097308	50
SS 2	8010097318	50
PS 1	8010197328	50
PS 2	8010197420	50
EPL TBL 2,5-10	8012396118	50
PR TBL 2,5 - 10	8012396408	50
SPR 2,5-10	8012396528	100
SCC 6/2	8013095223	50
SCC 6/3	8013095233	50
SCC 6/10	8013095203	10
TST-I 1	8014393108	50
MTG 8	8020386009	500
TBSL 5,15x5	8020384011	1
GM1	8014393008	50
GM2	8014393018	50
TM1	8014393020	50
0,6x3,5		

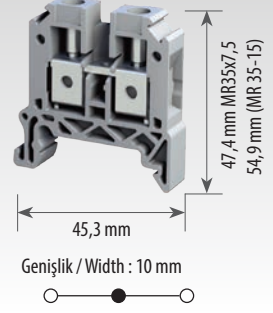
**TBL 10****TBL 10**

8000099048

60

800 V / 57 A

10

0,5 - 16

0,5 - 16

0,5 - 10

20-6 AWG

12

1,5

M4

8

3 / III / I

Ürün Adı Product Name	Sipariş No Order No.	Adet Qty.
DR 35-7,5 S 2M	8015393407	40
DR 35-15 S 2M	8015393427	20
SS 1	8010097308	50
SS 2	8010097318	50
PS 1	8010197328	50
PS 2	8010197420	50
EPL TBL 2,5-10	8012396118	50
PR TBL 2,5 - 10	8012396408	50
SPR 2,5-10	8012396528	100
SCC 10/2	8013095323	50
SCC 10/3	8013095333	50
SCC 10/10	8013095303	10
TST-I 1	8014393108	50
MTG 10	8020385009	250
TBSL 5,15x5	8020384011	1
GM1	8014393008	50
GM2	8014393018	50
TM1	8014393020	50
0,6x3,5		

\* TM1 Sadece PS2 ürünü ile Uyumludur.

\* TM1 is only suitable for PS2

## Vida Bağlantılı Ray Klemensleri Screw Type Terminal Blocks

### TBL Serisi Geçiş Klemensleri

TBL Series Feed Through Terminal Block



Ürün Adı / Product Name

Sipariş No / Order No.

Paket Adeti / Packing Qty.

Anma Değerleri / Rated Values

IEC 60947-7-1

Bağlantı Bilgileri / Connection Information

Kesit / Cross-Section (mm<sup>2</sup>)

Tek Damarlı Kablo / Solid Conductor Cross-Section min mm<sup>2</sup>: (mm<sup>2</sup>)-(min-max)

Çok Damarlı Kablo / Stranded Conductor Cross-Section (mm<sup>2</sup>)-(min-max)

Çok Tellili Kablo / Flexible Conductor Cross-Section (mm<sup>2</sup>)-(min-max)

AWG

Açıklamalar / Descriptions

Kablo Soyma Uzunluğu / Insulation Stripping Length (mm)

Max. Sıkma Torku (N.m) / Max. Tightening Torque

Bağlantı Vidası / Screw Diameter

Darbe Gerilimi / Rated Impulse Voltage (Kv)

Kirlilik Derecesi / Gerilim Kategorisi / Malzeme Grubu / Pollution Degree / Voltage Category / Material Group

Aksesuarlar / Accessories

Montaj Rayı / Din Rail

Durdurucu / End Stopper

Ayırma Plakası / Partition Plate

Üst Köprü / Cross Connection

Test Fişi / Test Plug

Klemens Etiketi / Marking Tags

Grup Etiketi / Group Label

Tornavida / Screwdriver

\* TM1 Sadece PS2 ürünü ile Uyumludur.

\* TM1 is only suitable for PS2

Renk Kodları / Color Codes

800009900....

...0

...1

...2

...3

...4

...5

...6

...9

## TBL 16

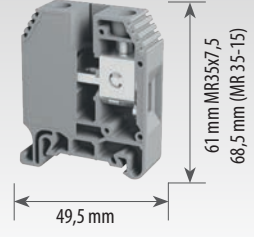

Genişlik / Width : 12,5 mm



## TBL 16

8000099058

50

1000 V / 76 A

16

0,5 - 16

0,5 - 16

0,5 - 16

20-6 AWG

12,3

2,5

M5

8

3 / III / I

Ürün Adı Product Name	Sipariş No Order No.	Adet Qty.
DR 35-7,5 S 2M	8015393407	40
DR 35-15 S 2M	8015393427	20
SS 1	8010097308	50
SS 2	8010097318	50
PS 1	8010197328	50
PS 2	8010197420	50
GPR	8012396568	20
SCC 16/2	8013095423	20
SCC 16/3	8013095433	20
SCC 16/10	8013095403	10
TST-1 1	8014393108	50
TST 2	8014393237	10
MTG 10	8020385009	250
GM1	8014393008	50
GM2	8014393018	50
TM1	8014393020	50
1,0x5,5		

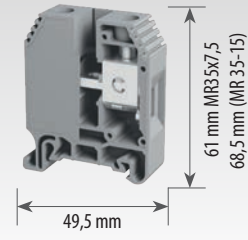
**TBL 25**

Genişlik / Width : 13,6 mm

**TBL 25**

8000099068

50

1000 V / 101 A

25

0,5 - 25

0,5 - 25

0,5 - 25

20-4 AWG

12,3

2,5

M5

8

3 / III / I

Ürün Adı Product Name	Sipariş No Order No.	Adet Qty.
DR 35-7,5 S 2M	8015393407	40
DR 35-15 S 2M	8015393427	20
SS 1	8010097308	50
SS 2	8010097318	50
PS 1	8010197328	50
PS 2	8010197420	50
GPR	8012396568	20
SCC 25/2	8013095523	20
SCC 25/3	8013095533	20
SCC 25/10	8013095503	10
TST-I 1	8014393108	10
TST 2	8014393237	10
MTG 10	8020385009	250
GM1	8014393008	50
GM2	8014393018	50
TM1	8014393020	50
1,0x5,5		

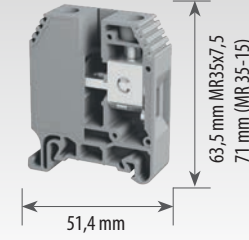
**TBL 35**

Genişlik / Width : 16,5 mm

**TBL 35**

8000099078

20

1000 V / 125 A

35

1,5 - 35

1,5 - 35

1,5 - 35

16-2 AWG

14,9

3,5

M6

8

3 / III / I

Ürün Adı Product Name	Sipariş No Order No.	Adet Qty.
DR 35-7,5 S 2M	8015393407	40
DR 35-15 S 2M	8015393427	20
SS 1	8010097308	50
SS 2	8010097318	50
PS 1	8010197328	50
PS 2	8010197420	50
GPR	8012396568	20
SCC 35/2	8013095623	20
SCC 35/3	8013095633	20
SCC 35/10	8013095603	10
TST 4	8014393257	50
MTG 10	8020385009	250
GM1	8014393008	50
GM2	8014393018	50
TM1	8014393020	50
1,2x6,5		

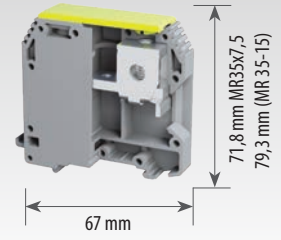
**TBL 50**

Genişlik / Width : 20,1 mm

**TBL 50**

8000099088

20

1000 V / 150 A

50

6 - 50

6 - 50

10 - 50

10-0 AWG

19

8

M8

8

3 / III / I

Ürün Adı Product Name	Sipariş No Order No.	Adet Qty.
DR 35-7,5 S 2M	8015393407	40
DR 35-15 S 2M	8015393427	20
SS 1	8010097308	50
SS 2	8010097318	50
PS 1	8010197328	50
PS 2	8010197420	50
GPR	8012396568	20
SCC 50/2	8013095723	10
SCC 50/3	8013095733	10
MTG 10	8020385009	250
GM1	8014393008	50
GM2	8014393018	50
TM1	8014393020	50
Alyen / Allen Wrench 4		

\* TM1 Sadece PS2 ürünü ile Uyumludur.

\* TM1 is only suitable for PS2

## Vida Bağlantılı Ray Klemensleri Screw Type Terminal Blocks

### TBL Serisi Geçiş Klemensleri

TBL Series Feed Through Terminal Block



**Ürün Adı / Product Name**

**Sipariş No / Order No.**

**Paket Adeti / Packing Qty.**

**Anma Değerleri / Rated Values**

IEC 60947-7-1

**Bağlantı Bilgileri / Connection Information**

**Kesit / Cross-Section (mm<sup>2</sup>)**

**Tek Damarlı Kablo / Solid Conductor Cross-Section min mm<sup>2</sup>: (mm<sup>2</sup>)-(min-max)**

**Çok Damarlı Kablo / Stranded Conductor Cross-Section (mm<sup>2</sup>)-(min-max)**

**Çok Tellî Kablo / Flexible Conductor Cross-Section (mm<sup>2</sup>)-(min-max)**

**AWG**

**Açıklamalar / Descriptions**

**Kablo Soyma Uzunluğu / Insulation Stripping Length (mm)**

**Max. Sıkma Torku (N.m) / Max. Tightening Torque**

**Bağlantı Vidası / Screw Diameter**

**Darbe Gerilimi / Rated Impulse Voltage (Kv)**

**Kirlilik Derecesi / Gerilim Kategorisi / Malzeme Grubu / Pollution Degree / Voltage Category / Material Group**

**Aksesuarlar / Accessories**

**Montaj Rayı / Din Rail**

**Durdurucu / End Stopper**

**Üst Köprü / Cross Connection**

**Klemens Etiketleri / Marking Tags**

**Grup Etiketleri / Group Label**

**Alyen / Allen Wrench**

\* **TM1 Sadece PS2 ürünü ile Uyumludur.**

\* TM1 is only suitable for PS2

## TBL 70

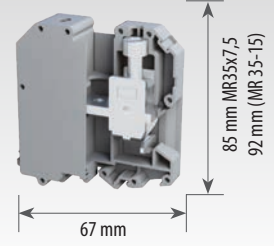

Genişlik / Width : 22 mm



## TBL 70

8000099098

10

1000 V / 192 A

70

6 - 70

6 - 70

10 - 70

8-0 AWG

19

10

M8

8

3 / III / I

Ürün Adı Product Name	Sipariş No Order No.	Adet Qty.
DR 35-7,5 S 2M	8015393407	40
DR 35-15 S 2M	8015393427	20
SS 1	8010097308	50
SS 2	8010097318	50
PS 1	8010197328	50
PS 2	8010197420	50
SCC 70/2	8013095823	10
SCC 70 /3	8013095833	10
MTG 10	8020385009	250
GM1	8014393008	50
GM2	8014393018	50
TM1	8014393020	50
6		

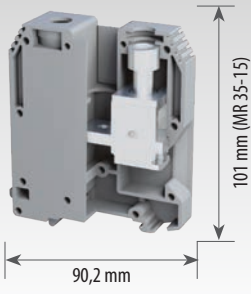
**TBL 95**

Genişlik / Width : 25,3 mm

**TBL 95**

8000099108

5

1000 V / 232 A

95

6 - 95

6 - 95

10 - 95

10-3/0 AWG

24.5

14

M8

8

3 / III / I

Ürün Adı Product Name	Sipariş No Order No.	Adet Qty.
DR 35-7,5 S 2M	8015393407	40
DR 35-15 S 2M	8015393427	20
SS 1	8010097308	50
SS 2	8010097318	50
PS 1	8010197328	50
PS 2	8010197420	50
SCC 95/2	8013095923	10
SCC 95/3	8013095933	10
MTG 10	8020385009	250
GM1	8014393008	50
GM2	8014393018	50
TM1	8014393020	50
6		

\* TM1 Sadece PS2 ürünü ile Uyumludur.

\* TM1 is only suitable for PS2

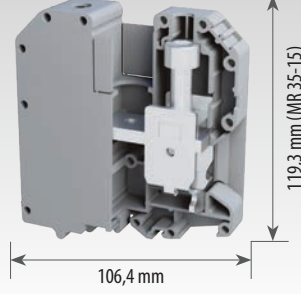
**TBL 150**

Genişlik / Width : 31 mm

**TBL 150**

8000099118

5

1000 V / 309 A

150

6 - 150

6 - 150

10 - 150

10-300 kcmil

27

22

M10

8

3 / III / I

Ürün Adı Product Name	Sipariş No Order No.	Adet Qty.
DR 35-7,5 S 2M	8015393407	40
DR 35-15 S 2M	8015393427	20
SS 1	8010097308	50
SS 2	8010097318	50
PS 1	8010197328	50
PS 2	8010197420	50
SCC 150/2	8013094023	10
MTG 10	8020385009	250
GM1	8014393008	50
GM2	8014393018	50
TM1	8014393020	50
8		

## Vida Bağlantılı Ray Klemensleri Screw Type Terminal Blocks

### Yüksek Akım Klemensi High Current Terminal Blocks



Ürün Adı / Product Name

Sipariş No / Order No.

Paket Adeti / Packing Qty.

Anma Değerleri / Rated Values

IEC 60947-7-1

Bağlantı Bilgileri / Connection Information

Kesit / Cross-Section (mm<sup>2</sup>)

Delik Çapı ve Bara Ölçüsü (mm) / Hole Diameter & Power Rail

DIN 46234 Norm Pabuç (min-max) (mm<sup>2</sup>) / Cable Lugs DIN 46234

DIN 46235 Norm Pabuç (min-max) (mm<sup>2</sup>) / Cable Lugs DIN 46235

AWG Kesit Aralığı DIN 46234 / AWG

AWG Kesit Aralığı DIN 46235 / AWG

Açıklamalar / Descriptions

Max. Sıkma Torku (N.m) / Max. Tightening Torque

Bağlantı Vidası / Screw Diameter

Darbe Gerilimi / Rated Impulse Voltage (kV)

Kirlilik Derecesi / Gerilim Kategorisi / Malzeme Grubu / Pollution Degree / Voltage Category / Material Group

Aksesuarlar / Accessories

Montaj Rayı / Din Rail

Koruma Kapağı / Isolation Cover

Durdurucu / End Stopper

Klemens Etiketi / Marking Tags

Grup Etiketi / Group Label

\* **TM1 Sadece PS2 ürünü ile Uyumludur.**

\* TM1 is only suitable for PS2

\*\* **Koruma kapakları ayrı satılmaktadır. (C-TBB)**

\*\* Isolation covers are sold separately. (C-TBB)

## TBB 70

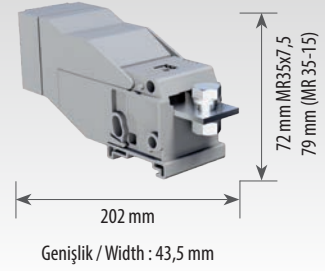

## TBB 70

8000099128

5

1000 V / 192 A

70

9/25x3

2,5 - 70

16 - 70

14-2/0

6-2/0

15-20

M8

8

3 / III / I

Ürün Adı Product Name	Sipariş No Order No.	Adet Qty.
DR 35-7,5 S 2M	8015393407	40
DR 35-15 S 2M	8015393427	20
C-TBB 70-95-150	8012396608	10
SS 1	8010097308	50
SS 2	8010097318	50
PS 1	8010197328	50
PS 2	8010197420	50
MTG 5	8020389009	500
GM1	8014393008	50
GM2	8014393018	50
TM1	8014393020	50

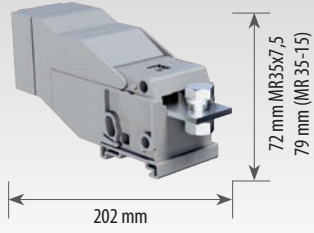
**TBB 95**

Genişlik / Width : 43,5 mm

**TBB 95**

8000099138

5

1000 V / 232 A

95

11/25x5

6 - 95

16 - 95

10-3/0

6-3/0

25-30

M10

8

3 / III / I

Ürün Adı Product Name	Sipariş No Order No.	Adet Qty.
DR 35-7,5 S 2M	8015393407	40
DR 35-15 S 2M	8015393427	20
C-TBB 70-95-150	8012396608	10
SS 1	8010097308	50
SS 2	8010097318	50
PS 1	8010197328	50
PS 2	8010197420	50
MTG 5	8020389009	500
GM1	8014393008	50
GM2	8014393018	50
TM1	8014393020	50

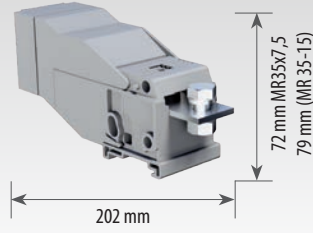
**TBB 150**

Genişlik / Width : 43,5 mm

**TBB 150**

8000099148

5

1000 V / 309 A

150

13/30x5

10 - 150

25 - 150

8-300 Kcmil

4-300 Kcmil

25-30

M12

8

3 / III / I

Ürün Adı Product Name	Sipariş No Order No.	Adet Qty.
DR 35-7,5 S 2M	8015393407	40
DR 35-15 S 2M	8015393427	20
C-TBB 70-95-150	8012396608	10
SS 1	8010097308	50
SS 2	8010097318	50
PS 1	8010197328	50
PS 2	8010197420	50
MTG 5	8020389009	500
GM1	8014393008	50
GM2	8014393018	50
TM1	8014393020	50

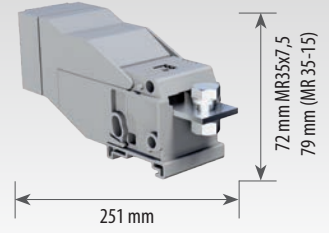
**TBB 240**

Genişlik / Width : 46,0 mm

**TBB 240**

8000099158

4

1000 V / 415 A

240

17/29,7x9,7

25 - 240

50 - 185

4-500 Kcmil

0-350 Kcmil

30-35

M16

8

3 / III / I

Ürün Adı Product Name	Sipariş No Order No.	Adet Qty.
DR 35-7,5 S 2M	8015393407	40
DR 35-15 S 2M	8015393427	20
C-TBB 240	8012396618	8
SS 1	8010097308	50
SS 2	8010097318	50
PS 1	8010197328	50
PS 2	8010197420	50
MTG 5	8020389009	500
GM1	8014393008	50
GM2	8014393018	50
TM1	8014393020	50

\* TM1 Sadece PS2 ürünü ile Uyumludur.

\* TM1 is only suitable for PS2

## Vida Bağlantılı Ray Klemensleri Screw Type Terminal Blocks

### Topraklama Klemensleri Earth Terminal Blocks



**Ürün Adı** / Product Name

**Sipariş No** / Order No.

**Paket Adeti** / Packing Qty.

**Anma Değerleri** / Rated Values

IEC 60947-7-1

**Bağlantı Bilgileri** / Connection Information

**Kesit** / Cross-Section (mm<sup>2</sup>)

**Tek Damarlı Kablo** / Solid Conductor Cross-Section min mm<sup>2</sup>: (mm<sup>2</sup>)-(min-max)

**Çok Damarlı Kablo** / Stranded Conductor Cross-Section (mm<sup>2</sup>)-(min-max)

**Çok Tellî Kablo** / Flexible Conductor Cross-Section (mm<sup>2</sup>)-(min-max)

**AWG**

**Açıklamalar** / Descriptions

**Kablo Soyma Uzunluğu** / Insulation Stripping Length (mm)

**Max. Sıkma Torku** (N.m) / Max. Tightening Torque

**Bağlantı Vidası** / Screw Diameter

**Darbe Gerilimi** / Rated Impulse Voltage (kV)

**Kirlilik Derecesi** / **Gerilim Kategorisi** / **Malzeme Grubu** / Pollution Degree / Voltage Category / Material Group

**Aksesuarlar** / Accessories

**Montaj Rayı** / Din Rail

**Durdurucu** / End Stopper

**Nihayet Plakası** / End Plate

**Klemens Etiketleri** / Marking Tags

**Grup Etiketleri** / Group Label

**Tornavida** / Screwdriver

\* **TM1 Sadece PS2 ürünü ile Uyumludur.**

\* TM1 is only suitable for PS2

## NTT 2,5 E

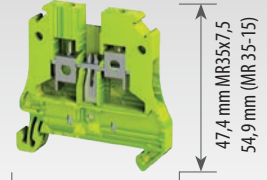

48,3 mm

Genişlik / Width : 6,0 mm

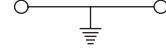

## NTT 2,5 E

8001099214

50

2,5

0,5 - 4

0,5 - 4

0,5 - 2,5

20-12 AWG

10

0,6

M2,5

6

3 / III / I

Ürün Adı Product Name	Sipariş No Order No.	Adet Qty.
DR 35-7,5 S 2M	8015393407	40
DR 35-15 S 2M	8015393427	20
SS 1	8010097308	50
SS 2	8010097318	50
PS 1	8010197328	50
PS 2	8010197420	50
EPL TBL 2,5-10	8012396118	50
MTG 6	8020388009	500
GM1	8014393008	50
GM2	8014393018	50
TM1	8014393020	50
0,5x3,0		

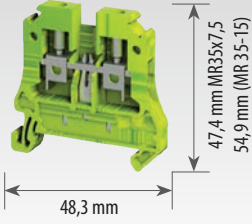

**NTT 4 E**

Genişlik / Width : 6,4 mm

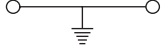
**NTT 4 E**

8001099224

50

4

0,5 - 4

0,5 - 4

0,5 - 4

20-12 AWG

12

0,8

M3

6

3 / III / I

Ürün Adı Product Name	Sipariş No Order No.	Adet Qty.
DR 35-7,5 S 2M	8015393407	40
DR 35-15 S 2M	8015393427	20
SS 1	8010097308	50
SS 2	8010097318	50
PS 1	8010197328	50
PS 2	8010197420	50
EPL TBL 2,5-10	8012396118	50
MTG 6,4	8020387009	500
GM1	8014393008	50
GM2	8014393018	50
TM1	8014393020	50
0,5x3,0		

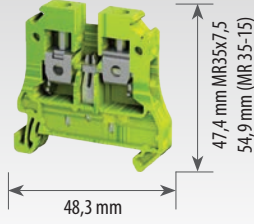
**NTT 6 E**

Genişlik / Width : 8,0 mm

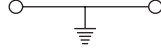
**NTT 6 E**

8001099234

25

6

0,5 - 10

0,5 - 10

0,5 - 6

20-8 AWG

12

1,2

M4

8

3 / III / I

Ürün Adı Product Name	Sipariş No Order No.	Adet Qty.
DR 35-7,5 S 2M	8015393407	40
DR 35-15 S 2M	8015393427	20
SS 1	8010097308	50
SS 2	8010097318	50
PS 1	8010197328	50
PS 2	8010197420	50
EPL TBL 2,5-10	8012396118	50
MTG 8	8020386009	500
GM1	8014393008	50
GM2	8014393018	50
TM1	8014393020	50
1,0x5,5		

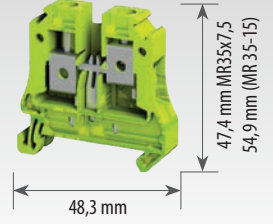
**NTT 10 E**

Genişlik / Width : 10,0 mm

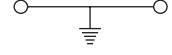
**NTT 10 E**

8001099244

20

10

0,5 - 16

0,5 - 16

0,5 - 10

20-6 AWG

12

1,5

M6

8

3 / III / I

Ürün Adı Product Name	Sipariş No Order No.	Adet Qty.
DR 35-7,5 S 2M	8015393407	40
DR 35-15 S 2M	8015393427	20
SS 1	8010097308	50
SS 2	8010097318	50
PS 1	8010197328	50
PS 2	8010197420	50
EPL TBL 2,5-10	8012396118	50
MTG 10	8020385009	250
GM1	8014393008	50
GM2	8014393018	50
TM1	8014393020	50
1,0x5,5		

\*TM1 Sadece PS2 ürünü ile Uyumludur.

\*TM1 is only suitable for PS2

## Vida Bağlantılı Ray Klemensleri Screw Type Terminal Blocks

### Topraklama Klemensleri Earth Terminal Blocks



**Ürün Adı / Product Name**

**Sipariş No / Order No.**

**Paket Adeti / Packing Qty.**

**Anma Değerleri / Rated Values**

IEC 60947-7-1

**Bağlantı Bilgileri / Connection Information**

**Kesit / Cross-Section (mm<sup>2</sup>)**

**Tek Damarlı Kablo / Solid Conductor Cross-Section min mm<sup>2</sup>: (mm<sup>2</sup>)-(min-max)**

**Çok Damarlı Kablo / Stranded Conductor Cross-Section (mm<sup>2</sup>)-(min-max)**

**Çok Tellî Kablo / Flexible Conductor Cross-Section (mm<sup>2</sup>)-(min-max)**

**AWG**

**Açıklamalar / Descriptions**

**Kablo Soyma Uzunluğu / Insulation Stripping Length (mm)**

**Max. Sıkma Torkü (N.m) / Max. Tightening Torque**

**Bağlantı Vidası / Screw Diameter**

**Darbe Gerilimi / Rated Impulse Voltage (kV)**

**Kirlilik Derecesi / Gerilim Kategorisi / Malzeme Grubu / Pollution Degree / Voltage Category / Material Group**

**Aksesuarlar / Accessories**

**Montaj Rayı / Din Rail**

**Durdurucu / End Stopper**

**Ayırma Plakası / Partition Plate**

**Klemens Etiketleri / Marking Tags**

**Grup Etiketleri / Group Label**

**Tornavida / Screwdriver**

\* **TM1 Sadece PS2 ürünü ile Uyumludur.**

\* TM1 is only suitable for PS2

## TBL 16 E

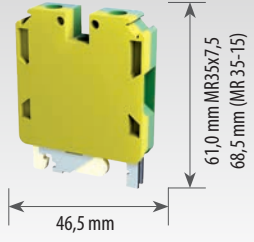

Genişlik / Width : 12,5 mm

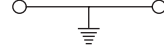

## TBL 16 E

8001099194

20

16

0,5 - 16

0,5 - 16

0,5 - 16

20-6 AWG

12,3

1,2

M5

8

3 / III / I

Ürün Adı Product Name	Sipariş No Order No.	Adet Qty.
DR 35-7,5 S 2M	8015393407	40
DR 35-15 S 2M	8015393427	20
SS 1	8010097308	50
SS 2	8010097318	50
PS 1	8010197328	50
PS 2	8010197420	50
GPR	8012396568	20
MTG 10	8020385009	250
GM1	8014393008	50
GM2	8014393018	50
TM1	8014393020	50
1,0x5,5		

## TBL 35 E

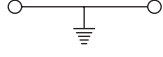
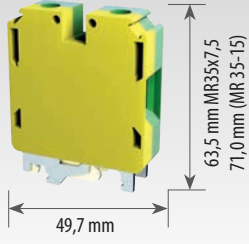

## TBL 35 E

8001099204

20

35

1,5 - 35

1,5 - 35

1,5 - 35

16-2 AWG

14,9

3,5

M6

8

3 / III / I

Ürün Adı Product Name	Sipariş No Order No.	Adet Qty.
DR 35-7,5 S 2M	8015393407	40
DR 35-15 S 2M	8015393427	20
SS 1	8010097308	50
SS 2	8010097318	50
PS 1	8010197328	50
PS 2	8010197420	50
GPR	8012396568	20
MTG 10	8020385009	250
GM1	8014393008	50
GM2	8014393018	50
TM1	8014393020	50
1,2x6,5		

\* **TM1 Sadece PS2 ürünü ile Uyumludur.**

\* TM1 is only suitable for PS2

## Vida Bağlantılı Ray Klemensleri Screw Type Terminal Blocks

### Çok Katlı Klemensler Multilevel Terminal Blocks



**Ürün Adı** / Product Name

**Sipariş No** / Order No.

**Paket Adeti** / Packing Qty.

**Anma Değerleri** / Rated Values

IEC 60947-7-1

**Bağlantı Bilgileri** / Connection Information

**Kesit** / Cross-Section (mm<sup>2</sup>)

**Tek Damarlı Kablo** / Solid Conductor Cross-Section min mm<sup>2</sup>: (mm<sup>2</sup>)-(min-max)

**Çok Damarlı Kablo** / Stranded Conductor Cross-Section (mm<sup>2</sup>)-(min-max)

**Çok Tellî Kablo** / Flexible Conductor Cross-Section (mm<sup>2</sup>)-(min-max)

**AWG**

**Açıklamalar** / Descriptions

**Kablo Soyma Uzunluğu** / Insulation Stripping Length (mm)

**Max. Sıkma Torku (N.m)** / Max. Tightening Torque

**Bağlantı Vidası** / Screw Diameter

**Darbe Gerilimi** / Rated Impulse Voltage (Kv)

**Kirlilik Derecesi / Gerilim Kategorisi / Malzeme Grubu** / Pollution Degree / Voltage Category / Material Group

**Aksesuarlar** / Accessories

**Montaj Rayı** / Din Rail

**Durdurucu** / End Stopper

**Nihayet Plakası** / End Plate

**Ayırma Plakası** / Partition Plate

**Mini Ayırma Dili** / Small Partition Plate

**Üst Köprü** / Cross Connection

**Tarak Köprü** / Comb Connector

**Test Fişi** / Test Plug

**Klemens Etiketi** / Marking Tags

**Grup Etiketi** / Group Label

**Tornavida** / Screwdriver

\* **TM1 Sadece PS2 ürünü ile Uyumludur.**

\* TM1 is only suitable for PS2

## TBL 2,5-4 2P



## TBL 2,5-4 2P

8002099438

50

500 V / 32 A

2,5 - 4

0,5 - 4

0,5 - 4

0,5 - 4

20-12 AWG

9

0,4

M2,5

6

3 / III / I

Ürün Adı Product Name	Sipariş No Order No.	Adet Qty.
DR 35-7,5 S 2M	8015393407	40
DR 35-15 S 2M	8015393427	20
SS 1	8010097308	50
SS 2	8010097318	50
PS 1	8010197328	50
PS 2	8010197420	50
EPL TBL 2,5-4 2P	8012396208	20
GPR	8012396568	20
SCC 2,5/2	8013095023	50
SCC 2,5/3	8013095033	50
SCC 2,5/10	8013095003	10
TCC 2,5/2	8013094223	50
TCC 2,5/3	8013094203	50
TCC 2,5/10	8013094233	10
TST 1	8014393227	50
MTG 6	8020388009	500
GM1	8014393008	50
GM2	8014393018	50
TM1	8014393020	50
0,5x3,0		

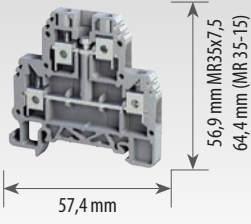
**TBL 2,5-4 2PK**

Genişlik / Width : 6,0 mm

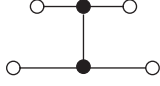
**TBL 2,5-4 2PK**

8002099448

50

500 V / 32 A

2,5 - 4

0,5 - 4

0,5 - 4

0,5 - 4

20-12 AWG

9

0,4

M2,5

6

3 / III / I

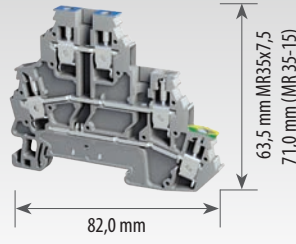
**TBL 2,5 - 2P+E**

Genişlik / Width : 6 mm

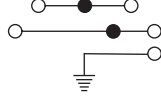
**TBL 2,5 - 2P+E**

8002099158

35

400 V / 24 A

2,5

0,5 - 4

0,5 - 4

0,5 - 4

20-12 AWG

9

0,4

M2,5

6

3 / III / I

Ürün Adı Product Name	Sipariş No Order No.	Adet Qty.
DR 35-7,5 S 2M	8015393407	40
DR 35-15 S 2M	8015393427	20
SS 1	8010097308	50
SS 2	8010097318	50
PS 1	8010197328	50
PS 2	8010197420	50
EPL TBL 2,5-4 2P	8012396208	20
GPR	8012396568	20
TCC 2,5/2	8013094223	50
TCC 2,5/3	8013094203	50
TCC 2,5/10	8013094233	10
TST 1	8014393227	50
MTG 6	8020388009	500
GM1	8014393008	50
GM2	8014393018	50
TM1	8014393020	50
0,5x3,0		

Ürün Adı Product Name	Sipariş No Order No.	Adet Qty.
DR 35-7,5 S 2M	8015393407	40
DR 35-15 S 2M	8015393427	20
SS 1	8010097308	50
SS 2	8010097318	50
PS 1	8010197328	50
PS 2	8010197420	50
EPL TBL 2,5 2P+E	8012396158	20
PR TBL 4 2P	8012396508	20
SPR TBL 4 2P	8012396558	100
SCC 2,5/2	8013095023	50
SCC 2,5/3	8013095033	50
SCC 2,5/10	8013095003	10
TCC 2,5/2	8013094223	50
TCC 2,5/3	8013094203	50
TCC 2,5/10	8013094233	10
TST 1	8014393227	50
MTG 6	8020388009	500
GM1	8014393008	50
GM2	8014393018	50
TM1	8014393020	50
0,5x3,0		

\* TM1 Sadece PS2 ürünü ile Uyumludur.

\* TM1 is only suitable for PS2

## Vida Bağlantılı Ray Klemensleri Screw Type Terminal Blocks

### Çok Katlı Klemensler Multilevel Terminal Blocks



<b>Ürün Adı / Product Name</b>
<b>Sipariş No / Order No.</b>
<b>Paket Adeti / Packing Qty.</b>
<b>Anma Değerleri / Rated Values</b>
IEC 60947-7-1
<b>Bağlantı Bilgileri / Connection Information</b>
<b>Kesit / Cross-Section (mm<sup>2</sup>)</b>
<b>Tek Damarlı Kablo / Solid Conductor Cross-Section min mm<sup>2</sup>: (mm<sup>2</sup>)-(min-max)</b>
<b>Çok Damarlı Kablo / Stranded Conductor Cross-Section (mm<sup>2</sup>)-(min-max)</b>
<b>Çok Telli Kablo / Flexible Conductor Cross-Section (mm<sup>2</sup>)-(min-max)</b>
<b>AWG</b>
<b>Açıklamalar / Descriptions</b>
<b>Kablo Soyma Uzunluğu / Insulation Stripping Length (mm)</b>
<b>Sıkma Torku (N.m) / Tightening Torque</b>
<b>Bağlantı Vidası / Screw Diameter</b>
<b>Darbe Gerilimi / Rated Impulse Voltage (Kv)</b>
<b>Kirlilik Derecesi / Gerilim Kategorisi / Malzeme Grubu / Pollution Degree / Voltage Category / Material Group</b>
<b>Aksesuarlar / Accessories</b>
<b>Montaj Rayı / Din Rail</b>
<b>Durdurucu / End Stopper</b>
<b>Nihayet Plakası / End Plate</b>
<b>Ayırma Plakası / Partition Plate</b>
<b>Üst Köprü / Cross Connection</b>
<b>Tarak Köprü / Comb Connector</b>
<b>Test Fişi / Test Plug</b>
<b>Klemens Etiketleri / Marking Tags</b>
<b>Grup Etiketleri / Group Label</b>
<b>Tornavida / Screwdriver</b>

\* TM1 Sadece PS2 ürünü ile uyumludur.

\* TM1 is only suitable for PS2

## TBL 4 2P

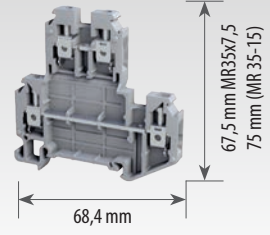

Genişlik / Width : 6,4 mm



## TBL 4 2P

8002099258

50

500 V / 32 A

4

0,5 - 4

0,5 - 4

0,5 - 4

20-12 AWG

9

0,4

M2,5

6

3 / III / I

Ürün Adı Product Name	Sipariş No Order No.	Adet Qty.
DR 35-7,5 S 2M	8015393407	40
DR 35-15 S 2M	8015393427	20
SS 1	8010097308	50
SS 2	8010097318	50
PS 1	8010197328	50
PS 2	8010197420	50
EPL1 TBL 4 2P	8012396218	20
EPL2 TBL 4 2P	8012396228	20
GPR	8012396568	20
SCC 4/2 TBL 4 2P	8013094123	50
SCC 4/3 TBL 4 2P	8013094133	50
SCC 4/10 TBL 4 2P	8013094103	10
TCC 4/2	8013094323	50
TCC 4/3	8013094333	50
TCC 4/10	8013094303	10
TST 1	8014393227	50
MTG 6,4	8020387009	500
GM1	8014393008	50
GM2	8014393018	50
TM1	8014393020	50
0,5x3,0		

## TBL 4 2P

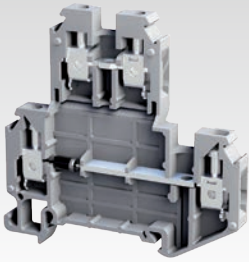

8002099268  
**TBL 4 2P X1**

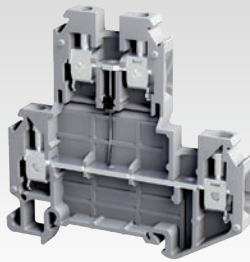

8002099278  
**TBL 4 2P X2**

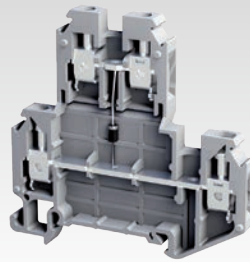

8002099288  
**TBL 4 2P X3**

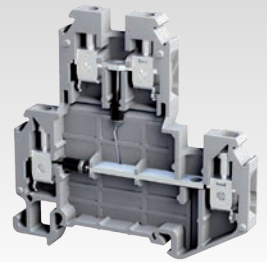

8002099298  
**TBL 4 2P X4**

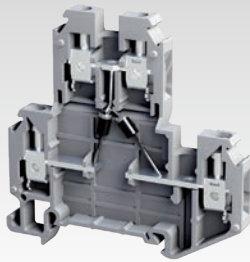

8002099318  
**TBL 4 2P X5**

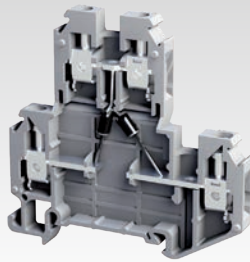

8002099328  
**TBL 4 2P X6**

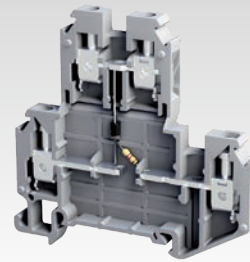

8002099348  
**TBL 4 2P X8**

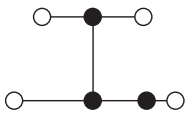

8002099428  
**TBL 4 2PK**

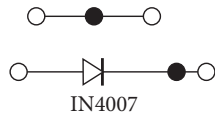

8002099268  
**TBL 4 2P X1**

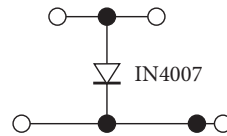

8002099278  
**TBL 4 2P X2**

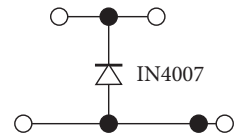

8002099288  
**TBL 4 2P X3**

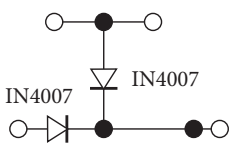

8002099298  
**TBL 4 2P X4**

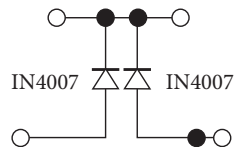

8002099305 **TBL 4 2P X5**  
8002099318 **TBL 4 2P X5**

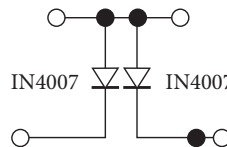

8002099328  
**TBL 4 2P X6**

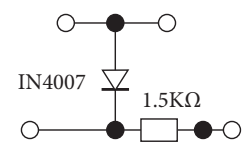

8002099348  
**TBL 4 2P X8**

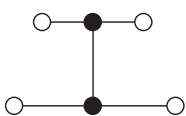

8002099448  
**TBL 2,5-4 2PK**

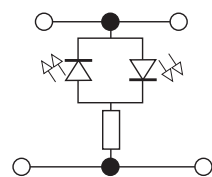

8002099458  
**TBL 2,5-4 2PL (24-48VAC/DC)**  
8002099468  
**TBL 2,5-4 2PL (110-220VAC/DC)**

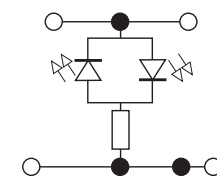

8002099368  
**TBL 4 2PL (24-48VAC/DC)**  
8002099378  
**TBL 4 2PL (110-220VAC/DC)**

## Vida Bağlantılı Ray Klemensleri Screw Type Terminal Blocks

### Çok Katlı Klemensler Multilevel Terminal Blocks



<b>Ürün Adı / Product Name</b>
<b>Sipariş No / Order No.</b>
<b>Paket Adeti / Packing Qty.</b>
<b>Anma Değerleri / Rated Values</b>
IEC 60947-7-1
<b>Bağlantı Bilgileri / Connection Information</b>
<b>Kesit / Cross-Section (mm<sup>2</sup>)</b>
<b>Tek Damarlı Kablo / Solid Conductor Cross-Section min mm<sup>2</sup>: (mm<sup>2</sup>)-(min-max)</b>
<b>Çok Damarlı Kablo / Stranded Conductor Cross-Section (mm<sup>2</sup>)-(min-max)</b>
<b>Çok Telli Kablo / Flexible Conductor Cross-Section (mm<sup>2</sup>)-(min-max)</b>
<b>AWG</b>
<b>Açıklamalar / Descriptions</b>
<b>Kablo Soyma Uzunluğu / Insulation Stripping Length (mm)</b>
<b>Sıkma Torku (N.m) / Tightening Torque</b>
<b>Bağlantı Vidası / Screw Diameter</b>
<b>Darbe Gerilimi / Rated Impulse Voltage (Kv)</b>
<b>Kirlilik Derecesi / Gerilim Kategorisi / Malzeme Grubu / Pollution Degree / Voltage Category / Material Group</b>
<b>Aksesuarlar / Accessories</b>
<b>Montaj Rayı / Din Rail</b>
<b>Durdurucu / End Stopper</b>
<b>Nihayet Plakası / End Plate</b>
<b>Ayırma Plakası / Partition Plate</b>
<b>Üst Köprü / Cross Connection</b>
<b>Tarak Köprü / Comb Connector</b>
<b>Test Fişi / Test Plug</b>
<b>Klemens Etiketi / Marking Tags</b>
<b>Grup Etiketi / Group Label</b>
<b>Tornavida / Screwdriver</b>

## TBL 4 2PK

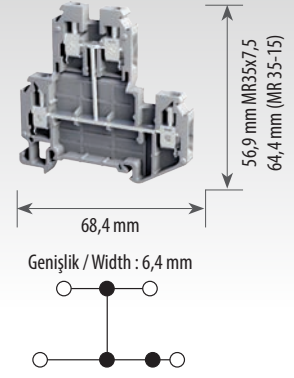

<b>TBL 4 2PK</b>		
8002099428		
25		
500 V / 32 A		
4		
0,5 - 4		
0,5 - 4		
0,5 - 4		
20-12 AWG		
9		
0,4		
M2,5		
6		
3 / III / I		
DR 35-7,5 S 2M	8015393407	40
DR 35-15 S 2M	8015393427	20
SS 1	8010097308	50
SS 2	8010097318	50
PS 1	8010197328	50
PS 2	8010197420	50
EPL1 TBL 4 2P	8012396218	20
EPL2 TBL 4 2P	8012396228	20
EPL3 TBL 4 2P	8012396238	20
GPR	8012396568	20
SCC 4/2 TBL 4 2P	8013094123	50
SCC 4/3 TBL 4 2P	8013094133	50
SCC 4/10 TBL 4 2P	8013094103	10
TCC 4/2	8013094323	50
TCC 4/3	8013094333	50
TCC 4/10	8013094303	10
TST 1	8014393227	50
MTG 6,4	8020387009	500
GM1	8014393008	50
GM2	8014393018	50
TM1	8014393020	50
0,5x3,0		

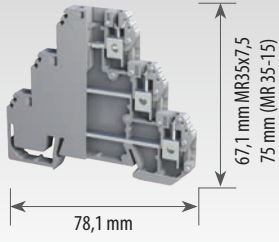

**TBL 4 3P**

Genişlik / Width : 6,4 mm

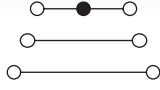
**TBL 4 3P**

8002099478

25

400 V / 32 A

4

0,5 - 4

0,5 - 4

0,5 - 4

20-12 AWG

9

0,4

M2,5

6

3 / III / I

Ürün Adı Product Name	Sipariş No Order No.	Adet Qty.
DR 35-7,5 S 2M	8015393407	40
DR 35-15 S 2M	8015393427	20
SS 1	8010097308	50
SS 2	8010097318	50
PS 1	8010197328	50
PS 2	8010197420	50
GPR	8012396568	20
SCC 4/2 TBL 4 2P	8013094123	50
SCC 4/3 TBL 4 2P	8013094133	50
SCC 4/10 TBL 4 2P	8013094103	10
TST 1	8014393227	50
MTG 6,4	8020387009	500
GM1	8014393008	50
GM2	8014393018	50
TM1	8014393020	50
0,5x3,0		

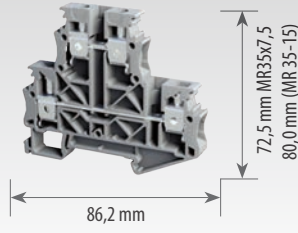
**TBL 10 - 2P**

Genişlik / Width : 10 mm

**TBL 10 - 2P**

8002099488

25

800 V / 57 A

10

0,5 - 4

0,5 - 4

0,5 - 4

20-12 AWG

9

0,4

M2,5

6

3 / III / I

Ürün Adı Product Name	Sipariş No Order No.	Adet Qty.
DR 35-7,5 S 2M	8015393407	40
DR 35-15 S 2M	8015393427	20
SS 1	8010097308	50
SS 2	8010097318	50
PS 1	8010197328	50
PS 2	8010197420	50
EPL TBL 10 2P	8012396298	20
GPR	8012396568	20
SCC 10/2	8013095323	50
SCC 10/3	8013095333	50
SCC 10/10	8013095303	10
TST 1	8014393227	50
MTG 10	8020385009	250
GM1	8014393008	50
GM2	8014393018	50
TM1	8014393020	50
0,5x3,0		

\* TM1 Sadece PS2 ürünü ile Uyumludur.

\* TM1 is only suitable for PS2

## Vida Bağlantılı Ray Klemensleri Screw Type Terminal Blocks

### Sigortalı ve Bıçaklı Ayırma Klemensleri Fuse and Disconnect Terminal Blocks



<b>Ürün Adı / Product Name</b>
<b>Sipariş No / Order No.</b>
<b>Paket Adeti / Packing Qty.</b>
<b>Anma Değerleri / Rated Values</b>
IEC 60947-7-3 (FDT 4) / IEC 60947-7-1 (TBL S)
<b>Bağlantı Bilgileri / Connection Information</b>
<b>Kesit / Cross-Section (mm<sup>2</sup>)</b>
<b>Tek Damarlı Kablo / Solid Conductor Cross-Section min mm<sup>2</sup>: (mm<sup>2</sup>)-(min-max)</b>
<b>Çok Damarlı Kablo / Stranded Conductor Cross-Section (mm<sup>2</sup>)-(min-max)</b>
<b>Çok Telli Kablo / Flexible Conductor Cross-Section (mm<sup>2</sup>)-(min-max)</b>
<b>AWG</b>
<b>Açıklamalar / Descriptions</b>
<b>Kablo Soyma Uzunluğu / Insulation Stripping Length (mm)</b>
<b>Max. Sıkma Torku (N.m) / Max. Tightening Torque</b>
<b>Bağlantı Vidası / Screw Diameter</b>
<b>Darbe Gerilimi / Rated Impulse Voltage (Kv)</b>
<b>Kirlilik Derecesi / Gerilim Kategorisi / Malzeme Grubu / Pollution Degree / Voltage Category / Material Group</b>
<b>Aksesuarlar / Accessories</b>
<b>Montaj Rayı / Din Rail</b>
<b>Durdurucu / End Stopper</b>
<b>Tarak Köprü / Comb Connector</b>
<b>Klemens Etiketleri / Marking Tags</b>
<b>Şerit Etiket / Strip Label</b>
<b>Grup Etiketleri / Group Label</b>
<b>Tornavida / Screwdriver</b>

\* **TM1 Sadece PS2 ürünü ile uyumludur.**

\* TM1 is only suitable for PS2

\*\* **Sigortalı ve bıçaklı ayırma klemenslerimiz iki tarafı kapalı tipte olduğundan, nihayet plakası seçimine gerek yoktur.**

\*\* Fuse and disconnect type terminal blocks are double side closed, no need for an extra end plate usage.

## FDT 4

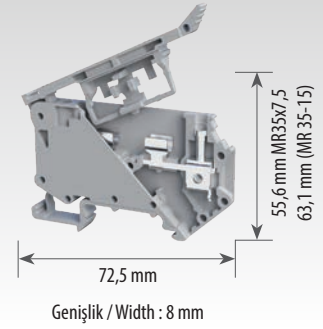

<b>FDT 4</b>		
8003099488		
25		
800 V / 6,3 A		
4		
0,5 - 4		
0,5 - 4		
0,5 - 4		
20-12 AWG		
12		
0,5		
M3		
8		
3 / III / I		
<b>Ürün Adı</b> Product Name	<b>Sipariş No</b> Order No.	<b>Adet</b> Qty.
DR 35-7,5 S 2M	8015393407	40
DR 35-15 S 2M	8015393427	20
SS 1	8010097308	50
SS 2	8010097318	50
PS 1	8010197328	50
PS 2	8010197420	50
TCC 6/2	8013394823	50
TCC 6/3	8013394833	50
TCC 6/10	8013394803	50
MTG 8	8020386009	500
TBSL 22X20	8020384009	1
GM1	8014393008	50
GM2	8014393018	50
TM1	8014393020	50
0,5x3,0		

## FDT 4 L

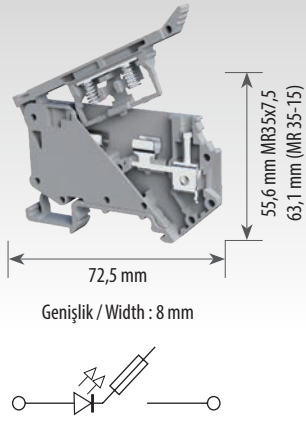

Genişlik / Width : 8 mm

### FDT 4 L (110-220 VAC/DC)

8003099508

25

800 V / 6,3 A

4

0,5 - 4

0,5 - 4

0,5 - 4

20-12 AWG

12

0,5

M3

8

3 / III / I

Ürün Adı Product Name	Sipariş No Order No.	Adet Qty.
DR 35-7,5 S 2M	8015393407	40
DR 35-15 S 2M	8015393427	20
SS 1	8010097308	50
SS 2	8010097318	50
PS 1	8010197328	50
PS 2	8010197420	50
TCC 6/2	8013394823	50
TCC 6/3	8013394833	50
TCC 6/10	8013394803	50
MTG 8	8020386009	500
TBSL 22X20	8020384009	1
GM1	8014393008	50
GM2	8014393018	50
TM1	8014393020	50
0,5x3,0		

\* TM1 Sadece PS2 ürünü ile Uyumludur.

\* TM1 is only suitable for PS2

\*\* Sigortalı ve bıçaklı ayırma klemenslerimiz iki tarafı kapalı tipte olduğundan, nihayet plakası seçimine gerek yoktur.

\*\* Fuse and disconnect type terminal blocks are double side closed, no need for an extra end plate usage.



### Mini Cam Sigorta Mini Glass Fuse

Ürün Adı Product Name	Sipariş No Order No.	Adet Qty.
MGF 0,05A	8014401200	10
MGF 0,25A	8014401210	10
MGF 0,5A	8014401220	10
MGF 1A	8014401230	10
MGF 2A	8014401240	10
MGF 2,5A	8014401250	10
MGF 3,15A	8014401260	10
MGF 4A	8014401270	10
MGF 5A	8014401280	10
MGF 6,3A	8014401290	10

### Sigorta Tipi Bakır Bara Fuse Shaped Copper Bar

Ürün Adı Product Name	Sipariş No Order No.	Adet Qty.
FSCB 5x20	8014401100	10

### FDT 4 L Series

Ürün Adı Product Name	Renk Color	Sipariş No Order No.	Adet Qty.
FDT 4 L (24-48 VAC/DC)	●	8003099498	25
FDT 4 L (110-220 VAC/DC)	●	8003099508	25
FDT 4 L (24-48 VAC/DC)	●	8003099496	25
FDT 4 L (110-220 VAC/DC)	●	8003099506	25
FDT 4	●	8003099486	25



## Vida Bağlantılı Ray Klemensleri Screw Type Terminal Blocks

### Sigortalı ve Bıçaklı Ayırma Klemensleri Fuse and Disconnect Terminal Blocks



Ürün Adı / Product Name

Sipariş No / Order No.

Paket Adeti / Packing Qty.

Anma Değerleri / Rated Values

IEC 60947-7-3 (FDT 4) / IEC 60947-7-1 (TBL S)

Bağlantı Bilgileri / Connection Information

Kesit / Cross-Section (mm<sup>2</sup>)

Tek Damarlı Kablo / Solid Conductor Cross-Section min mm<sup>2</sup>: (mm<sup>2</sup>)-(min-max)

Çok Damarlı Kablo / Stranded Conductor Cross-Section (mm<sup>2</sup>)-(min-max)

Çok Tellî Kablo / Flexible Conductor Cross-Section (mm<sup>2</sup>)-(min-max)

AWG

Açıklamalar / Descriptions

Kablo Soyma Uzunluğu / Insulation Stripping Length (mm)

Sıkma Torku (N.m) / Tightening Torque

Bağlantı Vidası / Screw Diameter

Darbe Gerilimi / Rated Impulse Voltage (Kv)

Kirlilik Derecesi / Gerilim Kategorisi / Malzeme Grubu / Pollution Degree / Voltage Category / Material Group

Aksesuarlar / Accessories

Montaj Rayı / Din Rail

Durdurucu / End Stopper

Tarak Köprü / Comb Connector

Klemens Etiketli / Marking Tags

Grup Etiketli / Group Label

Tornavida / Screwdriver

\* **TM1 Sadece PS2 ürünü ile Uyumludur.**

\* TM1 is only suitable for PS2

\*\* **Sigortalı ve bıçaklı ayırma klemenslerimiz iki tarafı kapalı tipte olduğundan, nihayet plakası seçimine gerek yoktur.**

\*\* Fuse and disconnect type terminal blocks are double side closed, no need for an extra end plate usage.

## TBL 2,5 S

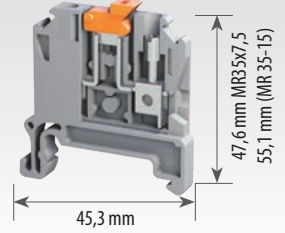

Genişlik / Width : 6 mm



## TBL 2,5 S

8003099528

50

500 V / 17,5 A

2,5

0,5 - 4

0,5 - 4

0,5 - 4

20-12 AWG

12

0,6

M2,5

6

3 / III / I

Ürün Adı Product Name	Sipariş No Order No.	Adet Qty.
DR 35-7,5 S 2M	8015393407	40
DR 35-15 S 2M	8015393427	20
SS 1	8010097308	50
SS 2	8010097318	50
PS 1	8010197328	50
PS 2	8010197420	50
TCC 2,5/2	8013094223	50
TCC 2,5/3	8013094203	50
TCC 2,5/10	8013094233	10
MTG 6	8020388009	500
GM1	8014393008	50
GM2	8014393018	50
TM1	8014393020	50
0,5x3,0		



## Vida Bağlantılı Ray Klemensleri Screw Type Terminal Blocks

### Ölçme Ayırma Klemensleri

Test and Disconnect Terminal Blocks



<b>Ürün Adı</b> / Product Name
<b>Sipariş No</b> / Order No.
<b>Paket Adeti</b> / Packing Qty.
<b>Anma Değerleri</b> / Rated Values
IEC 60947-7-1
<b>Bağlantı Bilgileri</b> / Connection Information
<b>Kesit</b> / Cross-Section (mm <sup>2</sup> )
<b>Tek Damarlı Kablo</b> / Solid Conductor Cross-Section min mm <sup>2</sup> : (mm <sup>2</sup> )-(min-max)
<b>Çok Damarlı Kablo</b> / Stranded Conductor Cross-Section (mm <sup>2</sup> )-(min-max)
<b>Çok Telli Kablo</b> / Flexible Conductor Cross-Section (mm <sup>2</sup> )-(min-max)
<b>AWG</b>
<b>Açıklamalar</b> / Descriptions
<b>Kablo Soyma Uzunluğu</b> / Insulation Stripping Length (mm)
<b>Max. Sıkma Torku (N.m)</b> / Max. Tightening Torque
<b>Bağlantı Vidası</b> / Screw Diameter
<b>Darbe Gerilimi</b> / Rated Impulse Voltage (Kv)
<b>Kirlilik Derecesi / Gerilim Kategorisi / Malzeme Grubu</b> / Pollution Degree / Voltage Category / Material Group
<b>Merkez Vida / Sıkma Torku (N.m)</b> / Center Screw / Tightening Torque
<b>Aksesuarlar</b> / Accessories
<b>Montaj Rayı</b> / Din Rail
<b>Durdurucu</b> / End Stopper
<b>Nihayet Plakası</b> / End Plate Section
<b>Kayar Köprü</b> / Swipe Connector
<b>Tarak Köprü</b> / Comb Connector
<b>Test Fişi</b> / Test Plug
<b>Klemens Etiketi</b> / Marking Tags
<b>Grup Etiketi</b> / Group Label
<b>Tornavida</b> / Screwdriver

\* **TM1 Sadece PS2 ürünü ile Uyumludur.**

\* TM1 is only suitable for PS2

## TDT-C 6

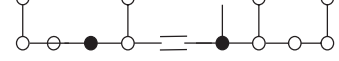
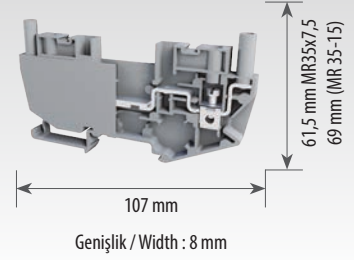

<b>TDT-C 6</b>		
8004099808		
20		
400 V / 41 A		
6		
0,5 - 10		
0,5 - 10		
0,5 - 6		
20-8 AWG		
12		
1,2		
M3,5		
6		
3 / III / I		
M3 / 0,5		
<b>Ürün Adı</b> Product Name	<b>Sipariş No</b> Order No.	<b>Adet</b> Qty.
DR 35-7,5 S 2M	8015393407	40
DR 35-15 S 2M	8015393427	20
SS 1	8010097308	50
SS 2	8010097318	50
PS 1	8010197328	50
PS 2	8010197420	50
SLC 2	8013394923	50
SLC 3	8013394933	50
SLC 4	8013394943	50
TCC 6/2	8013394823	50
TCC 6/3	8013394833	50
TCC 6/10	8013394803	10
TST-I 1	8014393108	50
MTG 8	8020386009	500
GM1	8014393008	50
GM2	8014393018	50
TM1	8014393020	50
0,5x3.0 / 0,6x3,5		

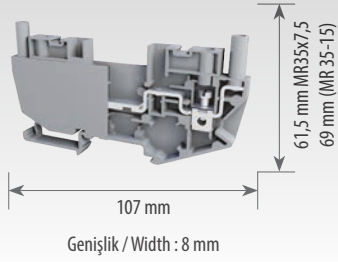
**TDT-V 6****TDT-V 6**

8004099818

20

400 V / 41 A

6

0,5 - 10

0,5 - 10

0,5 - 6

20-8 AWG

12

1,2

M3,5

6

3 / III / I

M3 / 0,5

Ürün Adı Product Name	Sipariş No Order No.	Adet Qty.
DR 35-7,5 S 2M	8015393407	40
DR 35-15 S 2M	8015393427	20
SS 1	8010097308	50
SS 2	8010097318	50
PS 1	8010197328	50
PS 2	8010197420	50
SLC 2	8013394923	50
SLC 3	8013394933	50
SLC 4	8013394943	50
TCC 6/2	8013394823	50
TCC 6/3	8013394833	50
TCC 6/10	8013394803	10
TST-I 1	8014393108	50
MTG 8	8020386009	500
GM1	8014393008	50
GM2	8014393018	50
TM1	8014393020	50
0,6x3,5		

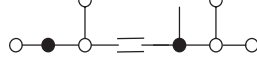
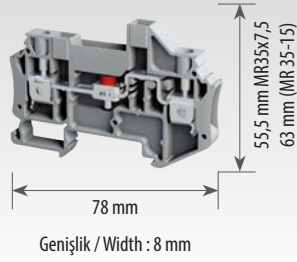
**TDS-C 6****TDS-C 6**

8004099828

25

400 V / 41 A

6

0,5 - 10

0,5 - 10

0,5 - 6

20-8 AWG

12

1,2

M3,5

6

3 / III / I

M3 / 0,5

Ürün Adı Product Name	Sipariş No Order No.	Adet Qty.
DR 35-7,5 S 2M	8015393407	40
DR 35-15 S 2M	8015393427	20
SS 1	8010097308	50
SS 2	8010097318	50
PS 1	8010197328	50
PS 2	8010197420	50
EPL TDS	8012396018	50
SLC 2	8013394923	50
SLC 3	8013394933	50
SLC 4	8013394943	50
TCC 6/2	8013394823	50
TCC 6/3	8013394833	50
TCC 6/10	8013394803	10
TST-I 1	8014393108	50
MTG 8	8020386009	500
GM1	8014393008	50
GM2	8014393018	50
TM1	8014393020	50
0,5x3,0 / 0,6x3,5		

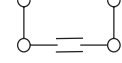
**TDV-C 6****TDV-C 6**

8004099838

25

500 V / 41 A

6

0,5 - 10

0,5 - 10

0,5 - 6

20-8 AWG

12

1,2

M3,5

6

3 / III / I

M3 / 0,5

Ürün Adı Product Name	Sipariş No Order No.	Adet Qty.
DR 35-7,5 S 2M	8015393407	40
DR 35-15 S 2M	8015393427	20
SS 1	8010097308	50
SS 2	8010097318	50
PS 1	8010197328	50
PS 2	8010197420	50
EPL TDV	8012396028	50
TCC 6/2	8013394823	50
TCC 6/3	8013394833	50
TCC 6/10	8013394803	10
TST-I 1	8014393108	50
MTG 5	8020389009	500
GM1	8014393008	50
GM2	8014393018	50
TM1	8014393020	50
1,0x5,5		

\* TM1 Sadece PS2 ürünü ile Uyumludur.

\* TM1 is only suitable for PS2

## Vida Bağlantılı Ray Klemensleri Screw Type Terminal Blocks

### Ölçme Ayırma Klemensleri Test and Disconnect Terminal Blocks



<b>Ürün Adı / Product Name</b>
<b>Sipariş No / Order No.</b>
<b>Paket Adeti / Packing Qty.</b>
<b>Anma Değerleri / Rated Values</b>
IEC 60947-7-1
<b>Bağlantı Bilgileri / Connection Information</b>
<b>Kesit / Cross-Section (mm<sup>2</sup>)</b>
<b>Tek Damarlı Kablo / Solid Conductor Cross-Section min mm<sup>2</sup>: (mm<sup>2</sup>)-(min-max)</b>
<b>Çok Damarlı Kablo / Stranded Conductor Cross-Section (mm<sup>2</sup>)-(min-max)</b>
<b>Çok Telli Kablo / Flexible Conductor Cross-Section (mm<sup>2</sup>)-(min-max)</b>
<b>AWG</b>
<b>Açıklamalar / Descriptions</b>
<b>Kablo Soyma Uzunluğu / Insulation Stripping Length (mm)</b>
<b>Max. Sıkma Torku (N.m) / Max. Tightening Torque</b>
<b>Bağlantı Vidası / Screw Diameter</b>
<b>Darbe Gerilimi / Rated Impulse Voltage (Kv)</b>
<b>Kirlilik Derecesi / Gerilim Kategorisi / Malzeme Grubu / Pollution Degree / Voltage Category / Material Group</b>
<b>Merkez Vida / Sıkma Torku (N.m) / Center Screw / Tightening Torque</b>
<b>Aksesuarlar / Accessories</b>
<b>Montaj Rayı / Din Rail</b>
<b>Durdurucu / End Stopper</b>
<b>Nihayet Plakası / End Plate Section</b>
<b>Kayar Köprü / Swipe Connector</b>
<b>Tarak Köprü / Comb Connector</b>
<b>Test Fişi / Test Plug</b>
<b>Klemens Etiketi / Marking Tags</b>
<b>Şerit Etiket / Strip Label</b>
<b>Grup Etiketi / Group Label</b>
<b>Tornavida / Screwdriver</b>

\* TM1 Sadece PS2 ürünü ile Uyumludur.

\* TM1 is only suitable for PS2

## TDS-V 6

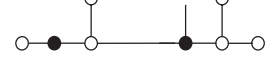
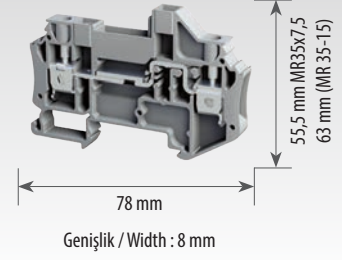

<b>TDS-V 6</b>
8004099848
25
400 V
6
0,5 - 10
0,5 - 10
0,5 - 6
20-8 AWG
12
1,2
M3,5
6
3 / III / I

Ürün Adı Product Name	Sipariş No Order No.	Adet Qty.
DR 35-7,5 S 2M	8015393407	40
DR 35-15 S 2M	8015393427	20
SS 1	8010097308	50
SS 2	8010097318	50
PS 1	8010197328	50
PS 2	8010197420	50
EPL TDS	8012396018	50
SLC 2	8013394923	50
SLC 3	8013394933	50
SLC 4	8013394943	50
TCC 6/2	8013394823	50
TCC 6/3	8013394833	50
TCC 6/10	8013394803	10
TST-1 1	8014393108	50
MTG 8	8020386009	500
TBSL 22X20	8020384009	1
GM1	8014393008	50
GM2	8014393018	50
TM1	8014393020	50
0,6x3,5		



## TDY-C 6

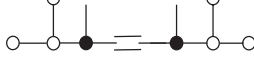
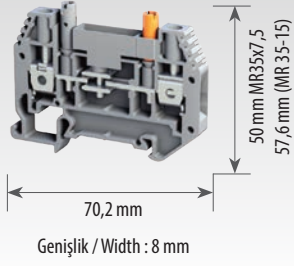

### TDY-C 6

8004099858

25

400 V

6

0,5 - 10

0,5 - 10

0,5 - 6

20-8 AWG

12

0,5

M3,5

6

3 / III / I

M3 / 0,5

Ürün Adı Product Name	Sipariş No Order No.	Adet Qty.
DR 35-7,5 S 2M	8015393407	40
DR 35-15 S 2M	8015393427	20
SS 1	8010097308	50
SS 2	8010097318	50
PS 1	8010197328	50
PS 2	8010197420	50
EPL TDY	8012396038	50
SLC-R 2	8014393307	50
SLC-R 3	8014393317	50
SLC-R 4	8014393327	50
TCC 6/2	8013394823	50
TCC 6/3	8013394833	50
TCC 6/10	8013394803	10
TST-I 1	8014393108	50
MTG 8	8020386009	500
GM1	8014393008	50
GM2	8014393018	50
TM1	8014393020	50
0,6x3,5 / 0,5x3.0		

\* TM1 Sadece PS2 ürünü ile Uyumludur.

\* TM1 is only suitable for PS2

## Push-in Klemensleri Push-in Terminal Blocks

### Geçiş Klemensleri Feed Through Terminal Blocks



**Ürün Adı / Product Name**

**Sipariş No / Order No.**

**Paket Adeti / Packing Qty.**

**Anma Değerleri / Rated Values**

IEC 60947-7-1

**Bağlantı Bilgileri / Connection Information**

**Kesit / Cross-Section (mm<sup>2</sup>)**

**Tek Damarlı Kablo / Solid Conductor Cross-Section min mm<sup>2</sup>: (mm<sup>2</sup>)-(min-max)**

**Çok Damarlı Kablo / Stranded Conductor Cross-Section (mm<sup>2</sup>)-(min-max)**

**Çok Tellî Kablo / Flexible Conductor Cross-Section (mm<sup>2</sup>)-(min-max)**

**AWG**

**Açıklamalar / Descriptions**

**Kablo Soyma Uzunluğu / Insulation Stripping Length (mm)**

**Max. Sıkma Torku (N.m) / Max. Tightening Torque**

**Bağlantı Vidası / Screw Diameter**

**Darbe Gerilimi / Rated Impulse Voltage (Kv)**

**Kirlilik Derecesi / Gerilim Kategorisi / Malzeme Grubu / Pollution Degree / Voltage Category / Material Group**

**Aksesuarlar / Accessories**

**Montaj Rayı / Din Rail**

**Durdurucu / End Stopper**

**Üst Köprü / Cross Connection**

**Klemens Etiketi / Marking Tags**

**Şerit Etiket / Strip Label**

**Grup Etiketi / Group Label**

\* **TM1 Sadece PS2 ürünü ile uyumludur.**

\* TM1 is only suitable for PS2

\*\* **PFT Serisi klemenslerimiz iki tarafı kapalı tipte olduğundan, nihayet plakası seçimine gerek yoktur.**

\*\* PFT Series terminal blocks are double side closed, no need for an extra end plate usage.

## PFT 2,5

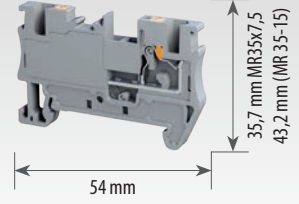

Genişlik / Width : 5,2 mm



## PFT 2,5

8000298008

100

800 V / 24 A

2,5

0,5 - 2,5

0,5 - 2,5

0,5 - 2,5

20-12 AWG

12

8

3 / III / I

Ürün Adı Product Name	Sipariş No Order No.	Adet Qty.
DR 35-7,5 S 2M	8015393407	40
DR 35-15 S 2M	8015393427	20
PS 1	8010197328	50
PS 2	8010197420	50
PCC 2,5/2	8013294523	100
PCC 2,5/3	8013294533	100
PCC 2,5/10	8013294503	10
MTG 5	8020389009	500
TBSL 22X20	8020384009	1
GM1	8014393008	50
GM2	8014393018	50
TM1	8014393020	50

**Renk Kodları / Color Codes**

800009900....

...0

...1

...2

...3

...4

...5

...6

...9

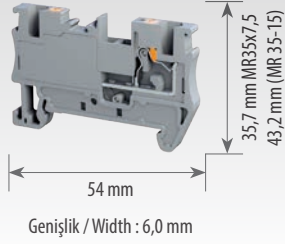
**PFT 4****PFT 4**

8000298018

100

800 V / 32 A

4

1,5 - 4

1,5 - 4

1,5 - 4

20-10 AWG

12

8

3 / III / I

Ürün Adı Product Name	Sipariş No Order No.	Adet Qty.
DR 35-7,5 S 2M	8015393407	40
DR 35-15 S 2M	8015393427	20
PS 1	8010197328	50
PS 2	8010197420	50
PCC 4/2	8013294623	100
PCC 4/3	8013294633	100
PCC 4/10	8013294603	10
MTG 6	8020388009	500
TBSL 22X20	8020384009	1
GM1	8014393008	50
GM2	8014393018	50
TM1	8014393020	50

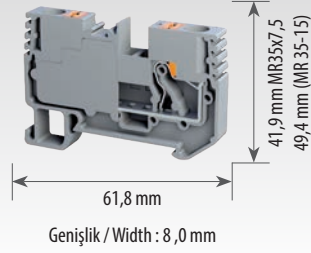
**PFT 6****PFT 6**

8000298028

50

1000 V / 41 A

6

1,5 - 6

1,5 - 6

1,5 - 6

20-8 AWG

12

8

3 / III / I

Ürün Adı Product Name	Sipariş No Order No.	Adet Qty.
DR 35-7,5 S 2M	8015393407	40
DR 35-15 S 2M	8015393427	20
PS 1	8010197328	50
PS 2	8010197420	50
PCC 6/2	8013294723	50
PCC 6/3	8013294733	50
PCC 6/10	8013294703	10
MTG 8	8020386009	500
TBSL 22X20	8020384009	1
GM1	8014393008	50
GM2	8014393018	50
TM1	8014393020	50

\* **TM1 Sadece PS2 ürünü ile Uyumludur.**

\* TM1 is only suitable for PS2

\* **PFT Serisi klemenslerimiz iki tarafı kapalı tipte olduğundan, nihayet plakası secimine gerek yoktur.**

\* PFT Series terminal blocks are double side closed, no need for an extra end plate usage.

## Push-in Klemensleri Push-in Terminal Blocks

### Geçiş Klemensleri Feed Through Terminal Blocks



<b>Ürün Adı / Product Name</b>
<b>Sipariş No / Order No.</b>
<b>Paket Adeti / Packing Qty.</b>
<b>Anma Değerleri / Rated Values</b>
IEC 60947-7-1
<b>Bağlantı Bilgileri / Connection Information</b>
<b>Kesit / Cross-Section (mm<sup>2</sup>)</b>
<b>Tek Damarlı Kablo / Solid Conductor Cross-Section min mm<sup>2</sup>: (mm<sup>2</sup>)-(min-max)</b>
<b>Çok Damarlı Kablo / Stranded Conductor Cross-Section (mm<sup>2</sup>)-(min-max)</b>
<b>Çok Tellli Kablo / Flexible Conductor Cross-Section (mm<sup>2</sup>)-(min-max)</b>
<b>AWG</b>
<b>Açıklamalar / Descriptions</b>
<b>Kablo Soyma Uzunluğu / Insulation Stripping Length (mm)</b>
<b>Sıkma Torku (N.m) / Tightening Torque</b>
<b>Bağlantı Vidası / Screw Diameter</b>
<b>Darbe Gerilimi / Rated Impulse Voltage (Kv)</b>
<b>Kirlilik Derecesi / Gerilim Kategorisi / Malzeme Grubu / Pollution Degree / Voltage Category / Material Group</b>
<b>Aksesuarlar / Accessories</b>
<b>Montaj Rayı / Din Rail</b>
<b>Durdurucu / End Stopper</b>
<b>Üst Köprü / Cross Connection</b>
<b>Klemens Etiketi / Marking Tags</b>
<b>Şerit Etiket / Strip Label</b>
<b>Grup Etiketi / Group Label</b>

\* **TM1 Sadece PS2 ürünü ile uyumludur.**

\* TM1 is only suitable for PS2

\*\* **PFT Serisi klemenslerimiz iki tarafı kapalı tipte olduğundan, nihayet plakası seçimine gerek yoktur.**

\*\* PFT Series terminal blocks are double side closed, no need for an extra end plate usage.

## PFT 10

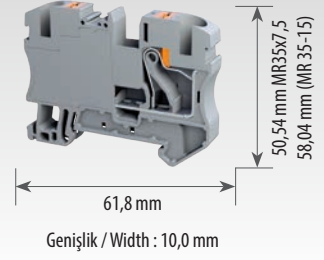

<b>PFT 10</b>		
8000298038		
30		
800 V / 57 A		
10		
0,5 - 16		
0,5 - 10		
0,5 - 10		
20-6 AWG		
18		
8		
3 / III / I		
<b>Ürün Adı / Product Name</b>	<b>Sipariş No / Order No.</b>	<b>Adet / Qty.</b>
DR 35-7,5 S 2M	8015393407	40
DR 35-15 S 2M	8015393427	20
PS 1	8010197328	50
PS 2	8010197420	50
PCC 10/2	8013294823	10
PCC 10/3	8013294833	10
MTG 10	8020385009	250
TBSL 22X20	8020384009	1
GM1	8014393008	50
GM2	8014393018	50
TM1	8014393020	50

<b>Renk Kodları / Color Codes</b>								
800009900....	...0	...1	...2	...3	...4	...5	...6	...9

## PFT 16

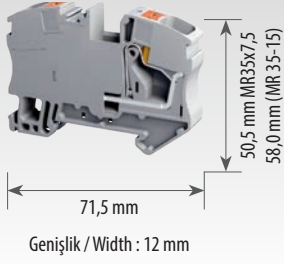

### PFT 16

8000298048

25

1000 V / 76 A

16

0,5 - 25

0,5 - 16

0,5 - 16

20-4 AWG

18

8

3 / III / I

Ürün Adı Product Name	Sipariş No Order No.	Adet Qty.
DR 35-7,5 S 2M	8015393407	40
DR 35-15 S 2M	8015393427	20
PS 1	8010197328	50
PS 2	8010197420	50
PCC 16/2	8013294923	10
PCC 16/3	8013294933	10
MTG 10	8020385009	250
TBSL 22X20	8020384009	1
GM1	8014393008	50
GM2	8014393018	50
TM1	8014393020	50

\* PFT Serisi klemenslerimiz iki tarafı kapalı tipte olduğundan, nihayet plakası secimine gerek yoktur.

\* PFT Series terminal blocks are double side closed, no need for an extra end plate usage.

\*\* PFT 16 sadece gri renkte temin edilmektedir.

\*\* PFT 16 is only available in grey.

\*\*\* TM1 Sadece PS2 ürünü ile Uyumludur.

\*\*\* TM1 is only suitable for PS2

## Push-in Klemensleri Push-in Terminal Blocks

## Topraklama Klemensleri Earth Terminal Blocks



**Ürün Adı / Product Name**

**Sipariş No / Order No.**

**Paket Adeti / Packing Qty.**

**Anma Değerleri / Rated Values**

IEC 60947-7-2

**Bağlantı Bilgileri / Connection Information**

**Kesit / Cross-Section (mm<sup>2</sup>)**

**Tek Damarlı Kablo / Solid Conductor Cross-Section min mm<sup>2</sup>: (mm<sup>2</sup>)-(min-max)**

**Çok Damarlı Kablo / Stranded Conductor Cross-Section (mm<sup>2</sup>)-(min-max)**

**Çok Telli Kablo / Flexible Conductor Cross-Section (mm<sup>2</sup>)-(min-max)**

**AWG**

**Açıklamalar / Descriptions**

**Kablo Soyma Uzunluğu / Insulation Stripping Length (mm)**

**Max. Sıkma Torku (N.m) / Max. Tightening Torque**

**Bağlantı Vidası / Screw Diameter**

**Darbe Gerilimi / Rated Impulse Voltage (Kv)**

**Kirlilik Derecesi / Gerilim Kategorisi / Malzeme Grubu / Pollution Degree / Voltage Category / Material Group**

**Aksesuarlar / Accessories**

**Montaj Rayı / Din Rail**

**Durdurucu / End Stopper**

**Klemens Etiketi / Marking Tags**

**Şerit Etiket / Strip Label**

**Grup Etiketi / Group Label**

\* **TM1 Sadece PS2 ürünü ile Uyumludur.**

\* TM1 is only suitable for PS2

\*\* **PFT Serisi klemenslerimiz iki tarafı kapalı tipte olduğundan, nihayet plakası secimine gerek yoktur.**

\*\* PFT Series terminal blocks are double side closed, no need for an extra end plate usage.

## PFT 2,5 E

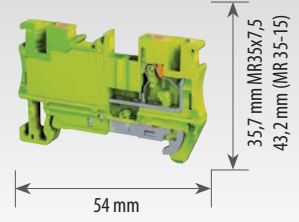

Genişlik / Width : 5,2 mm

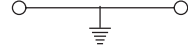

## PFT 2,5 E

8001298064

50

2,5

0,5 - 2,5

0,5 - 2,5

0,5 - 2,5

20-12 AWG

12

8

3 / III / I

Ürün Adı Product Name	Sipariş No Order No.	Adet Qty.
DR 35-7,5 S 2M	8015393407	40
DR 35-15 S 2M	8015393427	20
PS 1	8010197328	50
PS 2	8010197420	50
MTG 5	8020389009	500
TBSL 22X20	8020384009	1
GM1	8014393008	50
GM2	8014393018	50
TM1	8014393020	50

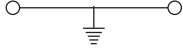
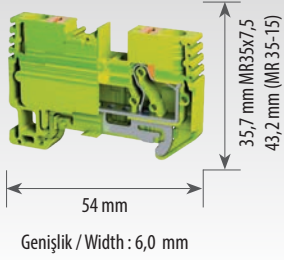
**PFT 4 E****PFT 4 E**

8001298074

50

4

1,5 - 4

1,5 - 4

1,5 - 4

20-10 AWG

12

8

3 / III / I

Ürün Adı Product Name	Sipariş No Order No.	Adet Qty.
DR 35-7,5 S 2M	8015393407	40
DR 35-15 S 2M	8015393427	20
PS 1	8010197328	50
PS 2	8010197420	50
MTG 6	8020389009	500
TBSL 22X20	8020384009	1
GM1	8014393008	50
GM2	8014393018	50
TM1	8014393020	50

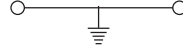
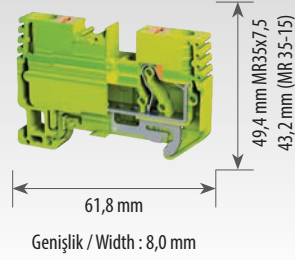
**PFT 6 E****PFT 6 E**

8001298084

25

6

1,5 - 6

1,5 - 6

1,5 - 6

20-8 AWG

12

8

3 / III / I

Ürün Adı Product Name	Sipariş No Order No.	Adet Qty.
DR 35-7,5 S 2M	8015393407	40
DR 35-15 S 2M	8015393427	20
PS 1	8010197328	50
PS 2	8010197420	50
MTG 8	8020389009	500
TBSL 22X20	8020384009	1
GM1	8014393008	50
GM2	8014393018	50
TM1	8014393020	50

\* **TM1 Sadece PS2 ürünü ile Uyumludur.**

\* TM1 is only suitable for PS2

\*\* **PFT Serisi klemenslerimiz iki tarafı kapalı tipte olduğundan, nihayet plakası secimine gerek yoktur.**

\*\* PFT Series terminal blocks are double side closed, no need for an extra end plate usage.

## Push-in Klemensleri Push-in Terminal Blocks

## Topraklama Klemensleri Earth Terminal Blocks



**Ürün Adı / Product Name**

**Sipariş No / Order No.**

**Paket Adeti / Packing Qty.**

**Anma Değerleri / Rated Values**

IEC 60947-7-2

**Bağlantı Bilgileri / Connection Information**

**Kesit / Cross-Section (mm<sup>2</sup>)**

**Tek Damarlı Kablo / Solid Conductor Cross-Section min mm<sup>2</sup>: (mm<sup>2</sup>)-(min-max)**

**Çok Damarlı Kablo / Stranded Conductor Cross-Section (mm<sup>2</sup>)-(min-max)**

**Çok Tellî Kablo / Flexible Conductor Cross-Section (mm<sup>2</sup>)-(min-max)**

**AWG**

**Açıklamalar / Descriptions**

**Kablo Soyma Uzunluğu / Insulation Stripping Length (mm)**

**Max. Sıkma Torku (N.m) / Max. Tightening Torque**

**Bağlantı Vidası / Screw Diameter**

**Darbe Gerilimi / Rated Impulse Voltage (Kv)**

**Kirlilik Derecesi / Gerilim Kategorisi / Malzeme Grubu / Pollution Degree / Voltage Category / Material Group**

**Aksesuarlar / Accessories**

**Montaj Rayı / Din Rail**

**Durdurucu / End Stopper**

**Klemens Etiketleri / Marking Tags**

**Şerit Etiket / Strip Label**

**Grup Etiketleri / Group Label**

\* **TM1 Sadece PS2 ürünü ile Uyumludur.**

\* TM1 is only suitable for PS2

\*\* **PFT Serisi klemenslerimiz iki tarafı kapalı tipte olduğundan, nihayet plakası secimine gerek yoktur.**

\*\* PFT Series terminal blocks are double side closed, no need for an extra end plate usage.

## PFT 10 E

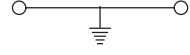
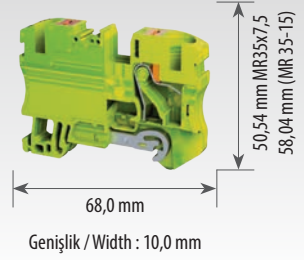

## PFT 10 E

8001298104

30

10

1,5 - 16

1,5 - 10

1,5 - 10

20-6 AWG

18

8

3 / III / I

Ürün Adı Product Name	Sipariş No Order No.	Adet Qty.
DR 35-7,5 S 2M	8015393407	40
DR 35-15 S 2M	8015393427	20
PS 1	8010197328	50
PS 2	8010197420	50
MTG 10	8020385009	250
TBSL 22X20	8020384009	1
GM1	8014393008	50
GM2	8014393018	50
TM1	8014393020	50



## PFT 16 E

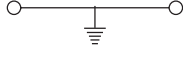
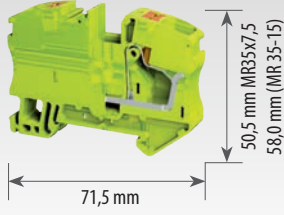

## PFT 16 E

8001298114

25

16

1,5 - 25

1,5 - 16

1,5 - 16

20-4 AWG

18

8

3 / III / I

Ürün Adı Product Name	Sipariş No Order No.	Adet Qty.
DR 35-7,5 S 2M	8015393407	40
DR 35-15 S 2M	8015393427	20
PS 1	8010197328	50
PS 2	8010197420	50
MTG 10	8020385009	250
TBSL 22X20	8020384009	1
GM1	8014393008	50
GM2	8014393018	50
TM1	8014393020	50

**\* TM1 Sadece PS2 ürünü ile Uyumludur.**

\* TM1 is only suitable for PS2

**\*\* PFT Serisi klemenslerimiz iki tarafı kapalı tipte olduğundan, nihayet plakası secimine gerek yoktur.**

\*\* PFT Series terminal blocks are double side closed, no need for an extra end plate usage.

## Push-in Klemensleri Push-in Terminal Blocks

**Çok Girişli ve Çıkışlı Klemensler**  
Multi - Entry and Multi - Level Terminal Blocks



<b>Ürün Adı / Product Name</b>
<b>Sipariş No / Order No.</b>
<b>Paket Adeti / Packing Qty.</b>
<b>Anma Değerleri / Rated Values</b>
IEC 60947-7-1 / IEC 60947-7-2 (PFT 2,5 2P+E)
<b>Bağlantı Bilgileri / Connection Information</b>
<b>Kesit / Cross-Section (mm<sup>2</sup>)</b>
<b>Tek Damarlı Kablo / Solid Conductor Cross-Section min mm<sup>2</sup>: (mm<sup>2</sup>)-(min-max)</b>
<b>Çok Damarlı Kablo / Stranded Conductor Cross-Section (mm<sup>2</sup>)-(min-max)</b>
<b>Çok Tellî Kablo / Flexible Conductor Cross-Section (mm<sup>2</sup>)-(min-max)</b>
<b>AWG</b>
<b>Açıklamalar / Descriptions</b>
<b>Kablo Soyma Uzunluğu / Insulation Stripping Length (mm)</b>
<b>Max. Sıkma Torku (N.m) / Max. Tightening Torque</b>
<b>Bağlantı Vidası / Screw Diameter</b>
<b>Darbe Gerilimi / Rated Impulse Voltage (Kv)</b>
<b>Kirlilik Derecesi / Gerilim Kategorisi / Malzeme Grubu / Pollution Degree / Voltage Category / Material Group</b>
<b>Aksesuarlar / Accessories</b>
<b>Montaj Rayı / Din Rail</b>
<b>Durdurucu / End Stopper</b>
<b>Üst Köprü / Cross Connection</b>
<b>Klemens Etiketi / Marking Tags</b>
<b>Şerit Etiket / Strip Label</b>
<b>Grup Etiketi / Group Label</b>

## PFT 2,5 1X2

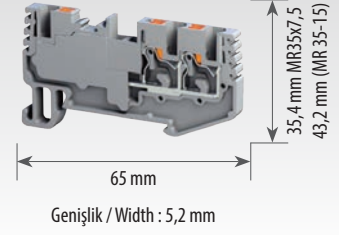

<b>PFT 2,5 1X2</b>		
8000298068		
40		
800 V / 24 A		
2,5		
0,5 - 2,5		
0,5 - 2,5		
0,5 - 2,5		
20-12 AWG		
12		
8		
3 / III / I		
<b>Ürün Adı / Product Name</b>	<b>Sipariş No / Order No.</b>	<b>Adet / Qty.</b>
DR 35-7,5 S 2M	8015393407	40
DR 35-15 S 2M	8015393427	20
PS 1	8010197328	50
PS 2	8010197420	50
PCC 2,5/2	8013294523	100
PCC 2,5/3	8013294533	100
PCC 2,5/10	8013294503	10
MTG 5	8020389009	500
TBSL 22X20	8020384009	1
GM1	8014393008	50
GM2	8014393018	50
TM1	8014393020	50
<b>Renk Kodları / Color Codes</b>		
800029806....	...0	...6

\* **TM1 Sadece PS2 ürünü ile uyumludur.**

\* TM1 is only suitable for PS2

\*\* **PFT Serisi klemenslerimiz iki tarafı kapalı tipte olduğundan, nihayet plakası secimine gerek yoktur.**

\*\* PFT Series terminal blocks are double side closed, no need for an extra end plate usage.

## PFT 2,5 2X2

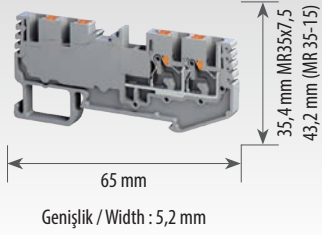

### PFT 2,5 2X2

8000298078

40

800 V / 24 A

2,5

0,5 - 2,5

0,5 - 2,5

0,5 - 2,5

20-12 AWG

12

8

3 / III / I

Ürün Adı Product Name	Sipariş No Order No.	Adet Qty.
DR 35-7,5 S 2M	8015393407	40
DR 35-15 S 2M	8015393427	20
PS 1	8010197328	50
PS 2	8010197420	50
PCC 2,5/2	8013294523	100
PCC 2,5/3	8013294533	100
PCC 2,5/10	8013294503	10
MTG 5	8020389009	500
TBSL 22X20	8020384009	1
GM1	8014393008	50
GM2	8014393018	50
TM1	8014393020	50

\* **TM1 Sadece PS2 ürünü ile Uyumludur.**

\* TM1 is only suitable for PS2

\*\* **PFT Serisi klemenslerimiz iki tarafı kapalı tipte olduğundan, nihayet plakası seçimine gerek yoktur.**

\*\* PFT Series terminal blocks are double side closed, no need for an extra end plate usage.

## Push-in Klemensleri Push-in Terminal Blocks

### Çok Girişli ve Çıkışlı Klemensler Multi - Entry and Multi - Level Terminal Blocks



<b>Ürün Adı / Product Name</b>
<b>Sipariş No / Order No.</b>
<b>Paket Adeti / Packing Qty.</b>
<b>Anma Değerleri / Rated Values</b>
IEC 60947-7-1 / IEC 60947-7-2 (PFT 2,5 2P+E)
<b>Bağlantı Bilgileri / Connection Information</b>
<b>Kesit / Cross-Section (mm<sup>2</sup>)</b>
<b>Tek Damarlı Kablo / Solid Conductor Cross-Section min mm<sup>2</sup>: (mm<sup>2</sup>)-(min-max)</b>
<b>Çok Damarlı Kablo / Stranded Conductor Cross-Section (mm<sup>2</sup>)-(min-max)</b>
<b>Çok Tellî Kablo / Flexible Conductor Cross-Section (mm<sup>2</sup>)-(min-max)</b>
<b>AWG</b>
<b>Açıklamalar / Descriptions</b>
<b>Kablo Soyma Uzunluğu / Insulation Stripping Length (mm)</b>
<b>Max. Sıkma Torku (N.m) / Max. Tightening Torque</b>
<b>Bağlantı Vidası / Screw Diameter</b>
<b>Darbe Gerilimi / Rated Impulse Voltage (Kv)</b>
<b>Kirlilik Derecesi / Gerilim Kategorisi / Malzeme Grubu / Pollution Degree / Voltage Category / Material Group</b>
<b>Aksesuarlar / Accessories</b>
<b>Montaj Rayı / Din Rail</b>
<b>Durdurucu / End Stopper</b>
<b>Üst Köprü / Cross Connection</b>
<b>Klemens Etiketi / Marking Tags</b>
<b>Şerit Etiket / Strip Label</b>
<b>Grup Etiketi / Group Label</b>

PFT 2,5 2P		
<b>PFT 2,5 2P</b>		
<b>8002298098</b>		
<b>50</b>		
<b>500 V / 24 A</b>		
<b>2,5</b>		
<b>0,5 - 2,5</b>		
<b>0,5 - 2,5</b>		
<b>0,5 - 2,5</b>		
<b>20-12 AWG</b>		
<b>12</b>		
<b>8</b>		
<b>3 / III / I</b>		
Ürün Adı Product Name	Sipariş No Order No.	Adet Qty.
DR 35-7,5 S 2M	8015393407	40
DR 35-15 S 2M	8015393427	20
PS 1	8010197328	50
PS 2	8010197420	50
PCC 2,5/2	8013294523	100
PCC 2,5/3	8013294533	100
PCC 2,5/10	8013294503	10
MTG 5	8020389009	500
TBSL 22X20	8020384009	1
GM1	8014393008	50
GM2	8014393018	50
TM1	8014393020	50

\* **TM1 Sadece PS2 ürünü ile Uyumludur.**

\* TM1 is only suitable for PS2

\*\* **PFT Serisi klemenslerimiz iki tarafı kapalı tipte olduğundan, nihayet plakası secimine gerek yoktur.**

\*\* PFT Series terminal blocks are double side closed, no need for an extra end plate usage.

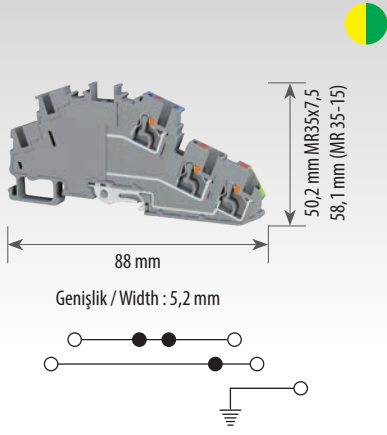
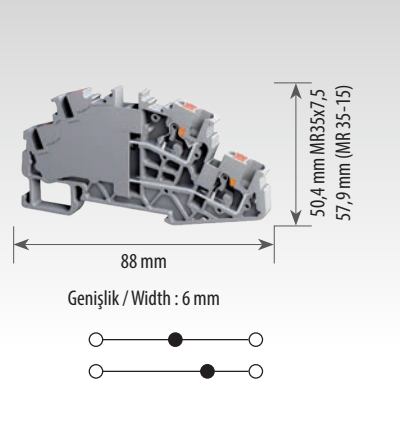
**PFT 2,5 2P+E****PFT 4 2P****PFT 2,5 2P+E**

8002298108

30

500 V / 24 A

2,5

0,5 - 2,5

0,5 - 2,5

0,5 - 2,5

20-12 AWG

12

8

3 / III / I

**PFT 4 2P**

8002298118

50

500 V / 32 A

4

1,5 - 4

1,5 - 4

1,5 - 4

20-10 AWG

12

8

3 / III / I

Ürün Adı Product Name	Sipariş No Order No.	Adet Qty.
DR 35-7,5 S 2M	8015393407	40
DR 35-15 S 2M	8015393427	20
PS 1	8010197328	50
PS 2	8010197420	50
PCC 2,5/2	8013294523	100
PCC 2,5/3	8013294533	100
PCC 2,5/10	8013294503	10
MTG 5	8020389009	500
TBSL 22X20	8020384009	1
GM1	8014393008	50
GM2	8014393018	50
TM1	8014393020	50

Ürün Adı Product Name	Sipariş No Order No.	Adet Qty.
DR 35-7,5 S 2M	8015393407	40
DR 35-15 S 2M	8015393427	20
PS 1	8010197328	50
PS 2	8010197420	50
PCC 4/2	8013294623	100
PCC 4/3	8013294633	100
PCC 4/10	8013294603	10
MTG 5	8020389009	500
TBSL 22X20	8020384009	1
GM1	8014393008	50
GM2	8014393018	50
TM1	8014393020	50

\* TM1 Sadece PS2 ürünü ile Uyumludur.

\* TM1 is only suitable for PS2

\*\* PFT Serisi klemenslerimiz iki tarafı kapalı tipte olduğundan, nihayet plakası secimine gerek yoktur.

\*\* PFT Series terminal blocks are double side closed, no need for an extra end plate usage.

## Sıra Klemensleri

Terminal Strips

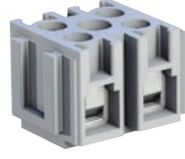

CSK 2,5



SRK 16/3

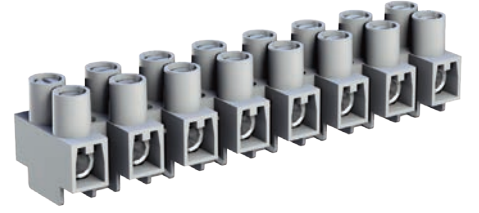

SRK 16/8



Ürün Adı Product Name	Sipariş No Order No.	Gerilim (V) Voltage (V)	Akım (A) Current (A)	Kesit (mm <sup>2</sup> ) Cross Section (mm <sup>2</sup> )	Kutup Sayısı Number of Poles	Vida Clamping Screw	Tork (Nm) Torque (Nm)	Paket Adeti Packing Qty.
SRK 16/2	8006097008	400	24	2,5	2	M 5	2	96
SRK 16/3	8006097018	400	24	2,5	3	M 5	2	32
SRK 16/4	8006097028	400	24	2,5	4	M 5	2	48
SRK 16/5	8006097038	400	24	2,5	5	M 5	2	32
SRK 16/6	8006097048	400	24	2,5	6	M 5	2	30
SRK 16/8	8006097058	400	24	2,5	8	M 5	2	24
SRK 16/10	8006097068	400	24	2,5	10	M 5	2	16
SRK 16/12	8006097078	400	24	2,5	12	M 5	2	8
CSK 2,5	8006097108	500	24	2,5	2	M 2,5	0,4 - 0,6	100
CSK 6	8006097118	800	41	6	2	M 3,5	0,8 - 1,2	60

## Durdurucular

End Bracket

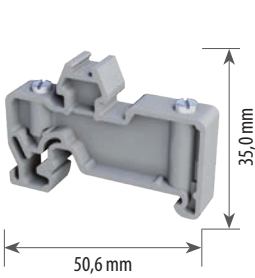

Genişlik / Width : 9,5 mm

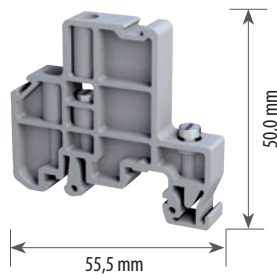

Genişlik / Width : 10,0 mm

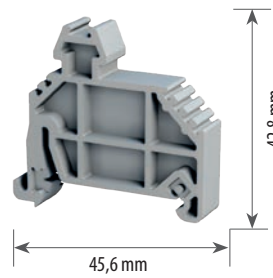

Genişlik / Width : 10,0 mm

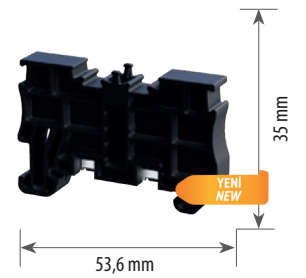

Genişlik / Width : 8,0 mm

Ürün Adı Product Name	SS 1
Sipariş No Order No.	8010097308
Montaj Fixing	Vidalı Screw Type
Renk Color	Gri Gray
Ray Rail	MR 35
Etiket Marker	MTG 5
Paket Adeti Packing Qty.	50

Ürün Adı Product Name	SS 2
Sipariş No Order No.	8010097318
Montaj Fixing	Vidalı Screw Type
Renk Color	Gri Gray
Ray Rail	MR 35 MR 32
Etiket Marker	MTG 5
Paket Adeti Packing Qty.	50

Ürün Adı Product Name	PS 1
Sipariş No Order No.	8010197328
Montaj Fixing	Push in Push in
Renk Color	Gri Gray
Ray Rail	MR 35
Etiket Marker	MTG 5
Paket Adeti Packing Qty.	50

Ürün Adı Product Name	PS 2
Sipariş No Order No.	8010197420
Montaj Fixing	Push in Push in
Renk Color	Siyah Black
Ray Rail	MR 35
Etiket Marker	MTG 5
Paket Adeti Packing Qty.	50

## Grup Etiketi

Group Marker

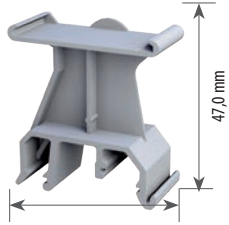

43,7 mm  
Genişlik / Width : 19,5 mm

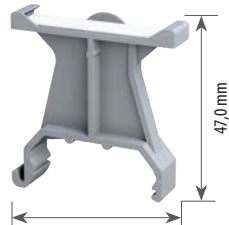

44,4 mm  
Genişlik / Width : 9,5 mm

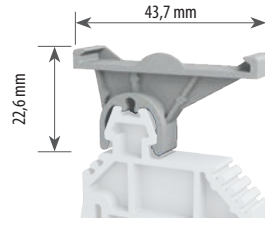

Genişlik / Width : 9,5 mm

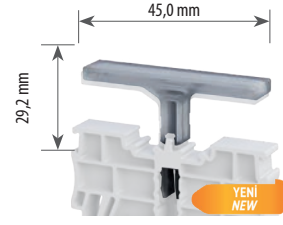

Genişlik / Width : 8,0 mm

Ürün Adı Product Name	<b>GM 1</b>
Sipariş No Order No.	8014393008
Renk Color	<b>Gri / Gray</b>
Ray Rail	MR 35
Paket Adeti Packing Qty.	50

Ürün Adı Product Name	<b>GM 2</b>
Sipariş No Order No.	8014393018
Renk Color	<b>Gri / Gray</b>
Ray Rail	MR 32 - MR 35
Paket Adeti Packing Qty.	50

Ürün Adı Product Name	<b>SL 1</b>
Sipariş No Order No.	8012396008
Renk Color	<b>Gri / Gray</b>
Paket Adeti Packing Qty.	50

Ürün Adı Product Name	<b>TM 1</b>
Sipariş No Order No.	8014393020
Renk Color	<b>Şeffaf / Transparent</b>
Paket Adeti Packing Qty.	50
<b>TM1 Sadece PS2 ürünü ile uyumludur.</b> TM1 is only suitable for PS2	

## Etiket Şemsiyesi

Marker Holder



Ürün Adı Product Name	<b>LHO</b>
Sipariş No Order No.	8020390009
Etiket Marker	TBSL 22x20
Paket Adeti Packing Qty.	10

## Nihayet Plakaları

End Plates



Ürün Adı Product Name	EPL NTB 2,5-10	EPL NTB 2,5-10 E	EPL NTB 2,5-4 2P
Sipariş No Order No.	8012396288	8012396284	8012396388
Renk Color	Gri / Gray	Sarı-Yeşil / Yellow-Green	Gri / Gray
Kullanıldığı Klemens Used with	NTB 2,5, NTB 4, NTB 6, NTB 10	NTB 2,5 E, NTB 4 E, NTB 6 E, NTB 10 E	NTB 2,5 2P, EPL NTB 2,5 P + E, NTB 4 2P
Paket Adeti Packing Qty.	50	50	20

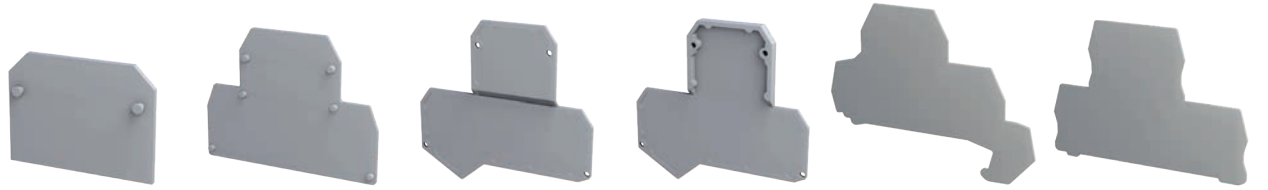

Ürün Adı Product Name	EPL TBL 2,5-10	EPL TBL 2,5-4 2P	EPL1 TBL 4 2P	EPL 2 TBL 4 2P	EPL TBL 2,5-2P+E	EPL TBL 10 2P
Sipariş No Order No.	8012396118	8012396208	8012396218	8012396228	8012396158	8012396298
Renk Color	Gri / Gray	Gri / Gray	Gri / Gray	Gri / Gray	Gri / Gray	Gri / Gray
Kullanıldığı Klemens Used with	TBL 2,5, TBL 4, TBL 6 TBL 10	TBL 2,5-4 2P	TBL 4 2P	TBL 4 2P	TBL 2,5 - 2P+E	TBL 10 2P
Paket Adeti Packing Qty.	50	20	20	20	20	20

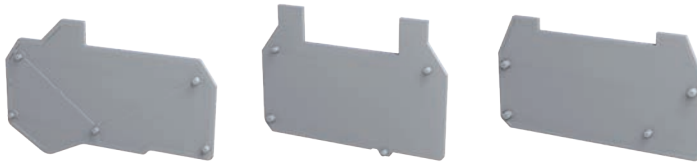

Ürün Adı Product Name	EPL TDS	EPL TDV	EPL TDY
Sipariş No Order No.	8012396018	8012396028	8012396038
Renk Color	Gri / Gray	Gri / Gray	Gri / Gray
Kullanıldığı Klemens Used with	TDS - C 6, TDS - V 6	TDV - C 6, TDS - V 6	TDY - C 6, TDY - C 6-1
Paket Adeti Packing Qty.	50	50	50



## Koruma Kapakları

Isolation Covers

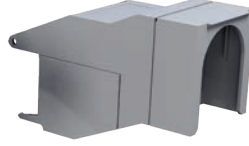

Ürün Adı Product Name	C-TBB 70-95-150	C-TBB 240
Sipariş No Order No.	8012396608	8012396618
Renk Color	Gri / Gray	Gri / Gray
Kullanıldığı Klemens Used with	TBB 70-95-150	TBB 240
Paket Adeti Packing Qty.	8	10

## Ayrırma Plakaları

Partition Plates

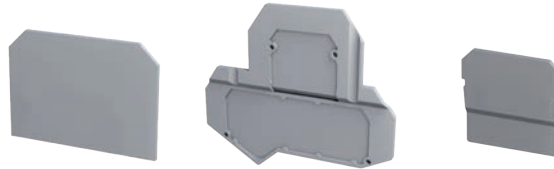

Ürün Adı Product Name	PR TBL 2,5-10	PR TBL 4 2P	SPR 2,5-10
Sipariş No Order No.	8012396408 8012396406	8012396508	8012396528
Renk Color	Gri / Gray	Gri / Gray	Gri / Gray
Kullanıldığı Klemens Used with	TBL 4, TBL 6, TBL 10	TBL 4 2P	TBL 2,5, TBL 4, TBL 6, TBL 10
Paket Adeti Packing Qty.	50	20	100

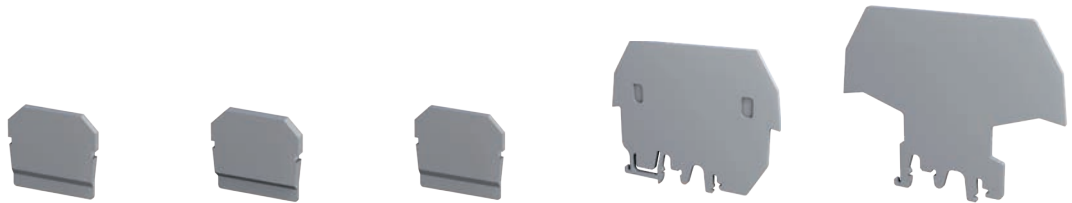

Ürün Adı Product Name	SPR 16-35	SPR 50	SPR TBL 4 2P	GPR	CHO
Sipariş No Order No.	8012396538	8012396548	8012396558	8012396568 8012396566	8012396578
Renk Color	Gri / Gray	Gri / Gray	Gri / Gray	Gri / Gray	Gri / Gray
Kullanıldığı Klemens Used with	TBL 16, TBL 35	TBL 50	TBL 4 2P	TBL 16, TBL 35, TBL 50	TBL 16, TBL 35, TBL 50
Paket Adeti Packing Qty.	50	50	100	20	20

## Test Fişleri

### Test Sockets



Sipariş No Order No.	Ürün Adı Product Name	Birlikte Kullanıldığı Klemens Used in Terminal	Renk Color	Amb. Mik. Pack. Qty (Adet/Pcs.)
8014393106	<b>TST-I 1</b>	TBL 6, TBL 10, TDT-C, TDT-V, TDS-C, TDS-V	<b>Mavi / Blue</b>	50
8014393104	<b>TST-I 1</b>	TBL 6, TBL 10, TDT-C, TDT-V, TDS-C, TDS-V	<b>Sarı / Yellow</b>	50
8014393108	<b>TST-I 1</b>	TBL 6, TBL 10, TDT-C, TDT-V, TDS-C, TDS-V	<b>Gri / Gray</b>	50
8014393102	<b>TST-I 1</b>	TBL 6, TBL 10, TDT-C, TDT-V, TDS-C, TDS-V	<b>Kırmızı / Red</b>	50
8014393100	<b>TST-I 1</b>	TBL 6, TBL 10, TDT-C, TDT-V, TDS-C, TDS-V	<b>Siyah / Black</b>	50
8014393227	<b>TST 1</b>	TBL 2,5, TBL 4, TBL 2,5-4 2P, TBL 4 2P, TBL 2,5 3P		50
8014393237	<b>TST 2</b>	TBL 10		50
8014393247	<b>TST 3</b>	TBL 16		50
8014393257	<b>TST 4</b>	TBL 25, TBL 35		50

## Tarak Köprüler

### Comb Connector



Sipariş No Order No.	Ürün Adı Product Name	Birlikte Kullanıldığı Klemens Used in Terminal	Pin Pole	Kesit (mm <sup>2</sup> ) Cross Section (mm <sup>2</sup> )	Renk Color	Amb. Mik. Pack. Qty (Adet/Pcs.)
8013094223	<b>TCC 2,5/2</b>	TBL 2,5, TBL 2,5-4 2P, TBL 2,5-4 2PK, TBL 2,5-4 2P+E NTB 2,5	2	2,5	<b>Gri / Grey</b>	50
8013094203	<b>TCC 2,5/3</b>	TBL 2,5, TBL 2,5-4 2P, TBL 2,5-4 2PK, TBL 2,5-4 2P+E NTB 2,5	3	2,5	<b>Gri / Grey</b>	50
8013094233	<b>TCC 2,5/10</b>	TBL 2,5, TBL 2,5-4 2P, TBL 2,5-4 2PK, TBL 2,5-4 2P+E, NTB 2,5	10	2,5	<b>Gri / Grey</b>	10
8013094323	<b>TCC 4/2</b>	TBL 4, NTB 4	2	4	<b>Gri / Grey</b>	50
8013094333	<b>TCC 4/3</b>	TBL 4, NTB 4	3	4	<b>Gri / Grey</b>	50
8013094303	<b>TCC 4/10</b>	TBL 4, NTB 4	10	4	<b>Gri / Grey</b>	10
8013394823	<b>TCC 6/2</b>	FDT 4, FDT 4L, TDT-C6, TDT-V6, TDS-C6, TDV-C6, TDS-V6, TDY-C6, NTB 6	2	6	<b>Gri / Grey</b>	50
8013394833	<b>TCC 6/3</b>	FDT 4, FDT 4L, TDT-C6, TDT-V6, TDS-C6, TDV-C6, TDS-V6, TDY-C6	3	6	<b>Gri / Grey</b>	50
8013394803	<b>TCC 6/10</b>	FDT 4, FDT 4L, TDT-C6, TDT-V6, TDS-C6, TDV-C6, TDS-V6, TDY-C6	10	6	<b>Gri / Grey</b>	10

## Vidalı Üst Köprüler

### Cross Connections

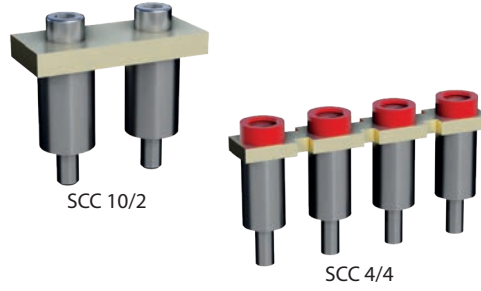

Sipariş No Order No.	Ürün Adı Product Name	Birlikte Kullanıldığı Klemens Used in Terminal	Kutup Sayısı Pole	Kesit (mm <sup>2</sup> ) Cross Section (mm <sup>2</sup> )	Amb. Mik. Pack. Qty (Adet/Pcs.)
8013095023	<b>SCC 2,5/2</b>	TBL 2,5, TBL 2,5-4 2P	2	2,5	50
8013095033	<b>SCC 2,5/3</b>	TBL 2,5, TBL 2,5-4 2P	3	2,5	50
8013095003	<b>SCC 2,5/10</b>	TBL 2,5, TBL 2,5-4 2P	10	2,5	10
8013095123	<b>SCC 4/2</b>	TBL 4, TBL 4 2P	2	4	50
8013095133	<b>SCC 4/3</b>	TBL 4, TBL 4 2P	3	4	50
8013095103	<b>SCC 4/10</b>	TBL 4, TBL 4 2P	10	4	10
8013095223	<b>SCC 6/2</b>	TBL 6	2	6	50
8013095233	<b>SCC 6/3</b>	TBL 6	3	6	50
8013095203	<b>SCC 6/10</b>	TBL 6	10	6	10
8013095323	<b>SCC 10/2</b>	TBL 10	2	6	50
8013095333	<b>SCC 10/3</b>	TBL 10	3	10	50
8013095303	<b>SCC 10/10</b>	TBL 10	10	10	10
8013095423	<b>SCC 16/2</b>	TBL 16	2	10	20
8013095433	<b>SCC 16/3</b>	TBL 16	3	16	20
8013095403	<b>SCC 16/10</b>	TBL 16	10	16	10
8013095523	<b>SCC 25/2</b>	TBL 25	2	16	20
8013095533	<b>SCC 25/3</b>	TBL 25	3	25	20
8013095503	<b>SCC 25/10</b>	TBL 25	10	25	10
8013095623	<b>SCC 35/2</b>	TBL 35	2	25	20
8013095633	<b>SCC 35/3</b>	TBL 35	3	35	20
8013095603	<b>SCC 35/10</b>	TBL 35	10	35	10
8013095723	<b>SCC 50/2</b>	TBL 50	2	50	10
8013095733	<b>SCC 50/3</b>	TBL 50	3	50	10
8013095823	<b>SCC 70/2</b>	TBL 70	2	70	10
8013095833	<b>SCC 70/3</b>	TBL 70	3	70	10
8013095923	<b>SCC 95/2</b>	TBL 95	2	95	10
8013095933	<b>SCC 95/3</b>	TBL 95	3	95	10
8013094023	<b>SCC 150/2</b>	TBL 150	2	150	10
8013094123	<b>SCC 4/2 TBL 4 2P</b>	TBL 4 2P	2	4	50
8013094133	<b>SCC 4/3 TBL 4 2P</b>	TBL 4 2P	3	4	50
8013094163	<b>SCC 4/6 TBL 4 2P</b>	TBL 4 2P	6	4	20
8013094103	<b>SCC 4/10 TBL 4 2P</b>	TBL 4 2P	10	4	10

## Push-in Üst Köprüler

Push-in Cross Connections

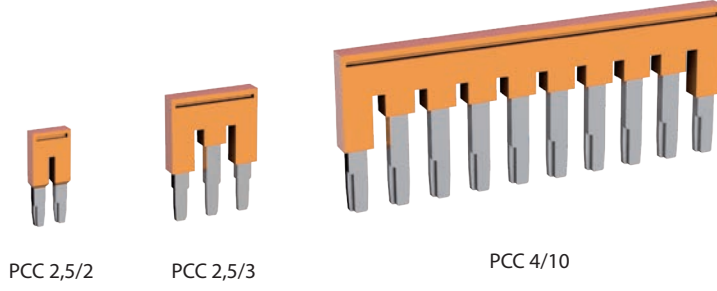

Sipariş No Order No.	Ürün Adı Product Name	Birlikte Kullanıldığı Klemens Used in Terminal	Kutup Sayısı Pole	Kesit (mm <sup>2</sup> ) Cross Section (mm <sup>2</sup> )	Amb. Mik. Pack. Qty (Adet/Pcs.)
8013294523	<b>PCC 2,5/2</b>	PFT 2,5, PFT 2,5 1x2, PFT 2,5 2x2, PFT 2,5 2P, PFT 2,5 E, NTB 2,5	2	2,5	100
8013294533	<b>PCC 2,5/3</b>	PFT 2,5, PFT 2,5 1x2, PFT 2,5 2x2, PFT 2,5 2P, PFT 2,5 E, NTB 2,5	3	2,5	100
8013294503	<b>PCC 2,5/10</b>	PFT 2,5, PFT 2,5 1x2, PFT 2,5 2x2, PFT 2,5 2P, PFT 2,5 E, NTB 2,5	10	2,5	10
8013294623	<b>PCC 4/2</b>	PFT 4, NTB 4	2	4	100
8013294633	<b>PCC 4/3</b>	PFT 4, NTB 4	3	4	100
8013294603	<b>PCC 4/10</b>	PFT 4, NTB 4	10	4	10
8013294723	<b>PCC 6/2</b>	PFT 6, NTB 6	2	6	50
8013294733	<b>PCC 6/3</b>	PFT 6, NTB 6	3	6	50
8013294703	<b>PCC 6/10</b>	PFT 6	10	6	10
8013295703	<b>PCC 6/10 - T</b>	NTB 6	10	6	10
8013294823	<b>PCC 10/2</b>	PFT 10, NTB 10	2	10	10
8013294833	<b>PCC 10/3</b>	PFT 10, NTB 10	3	10	10
8013294923	<b>PCC 16/2</b>	PFT 16	2	16	10
8013294933	<b>PCC 16/3</b>	PFT 16	3	16	10

## Kayar Köprüler

Sliding Connector

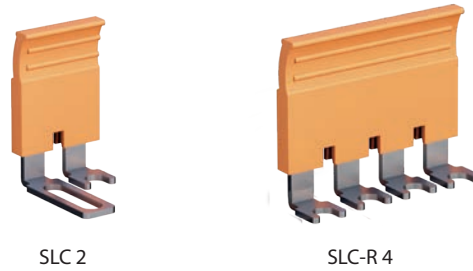

Sipariş No Order No.	Ürün Adı Product Name	Birlikte Kullanıldığı Klemens Used in Terminal	Kutup Sayısı Pole	Kesit (mm <sup>2</sup> ) Cross Section (mm <sup>2</sup> )	Amb. Mik. Pack. Qty (Adet/Pcs.)
8013394923	<b>SLC 2</b>	TDT-C 6, TDT-V 6, TDS-C 6, TDS-V 6	2	6	50
8013394933	<b>SLC 3</b>	TDT-C 6, TDT-V 6, TDS-C 6, TDS-V 6	3	6	50
8013394943	<b>SLC 4</b>	TDT-C 6, TDT-V 6, TDS-C 6, TDS-V 6	4	6	50
8014393307	<b>SLC-R 2</b>	TDY-C 6	2	6	50
8014393317	<b>SLC-R 3</b>	TDY-C 6	3	6	50
8014393327	<b>SLC-R 4</b>	TDY-C 6	4	6	50

## Klemens Etiketleri

### Marking Tags

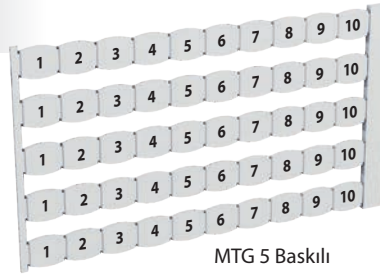

MTG 5 Baskılı

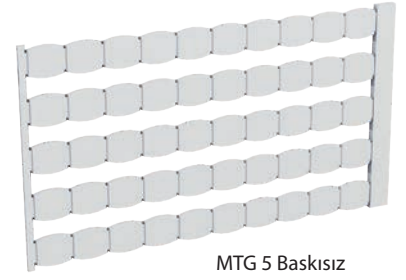

MTG 5 Baskısız

Ürün Kodu Product Code	Ürün Adı Product Name	Açıklama Description	Amb. Mik. Pack. Qty (Etiket - Tags / Pcs.)
8020389019	MTG 5 Baskılı	Baskılı / Printed	500
8020389009	MTG 5 Baskısız	Boş / Empty	500
8020389029	MTG 5 (1-10)	1-10	500
8020389039	MTG 5 (11-20)	11-20	500
8020389049	MTG 5 (21-30)	21-30	500
8020389059	MTG 5 (31-40)	31-40	500
8020389069	MTG 5 (41-50)	41-50	500
8020389079	MTG 5 (51-60)	51-60	500
8020389089	MTG 5 (61-70)	61-70	500
8020389099	MTG 5 (71-80)	71-80	500
8020389109	MTG 5 (81-90)	81-90	500
8020389119	MTG 5 (91-100)	91-100	500
8020389129	MTG 5 (1-50)	1-50	500
8020389139	MTG 5 (51-100)	51-100	500
8020389149	MTG 5 (101-150)	101-150	500
8020389159	MTG 5 (151-200)	151-200	500
8020389169	MTG 5 (201-250)	201-250	500
8020389179	MTG 5 (251-300)	251-300	500
8020389189	MTG 5 (301-350)	301-350	500
8020389199	MTG 5 (351-400)	351-400	500
8020389209	MTG 5 (401-450)	401-450	500
8020389219	MTG 5 (451-500)	451-500	500
8020388019	MTG 6 Baskılı	Baskılı / Printed	500
8020388009	MTG 6 Baskısız	Boş / Empty	500
8020388839	MTG 6 (L1, L2, L3, N)	L1, L2, L3, N	500
8020388309	MTG 6 (0)	0	500
8020388319	MTG 6 (1)	1	500
8020388599	MTG 6 (5)	5	500
8020388329	MTG 6 (2)	2	500
8020388339	MTG 6 (3)	3	500
8020388349	MTG 6 (4)	4	500
8020388359	MTG 6 (5)	5	500
8020388369	MTG 6 (6)	6	500
8020388379	MTG 6 (7)	7	500
8020388389	MTG 6 (8)	8	500
8020388399	MTG 6 (9)	9	500
8020388409	MTG 6 (10)	10	500
8020388029	MTG 6 (0-9)	0-9	500
8020388039	MTG 6 (1-10)	1-10	500
8020388879	MTG 6 (11-20)	11-20	500
8020388889	MTG 6 (21-30)	21-30	500
8020388899	MTG 6 (31-40)	31-40	500
8020388909	MTG 6 (41-50)	41-50	500
8020388919	MTG 6 (51-60)	51-60	500
8020388929	MTG 6 (61-70)	61-70	500
8020388939	MTG 6 (71-80)	71-80	500
8020388949	MTG 6 (81-90)	81-90	500
8020388959	MTG 6 (91-100)	91-100	500
8020388049	MTG 6 (1-50)	1-50	500
8020388059	MTG 6 (51-100)	51-100	500

## Klemens Etiketleri

### Marking Tags

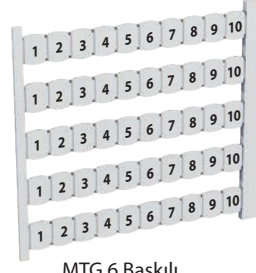

MTG 6 Baskılı

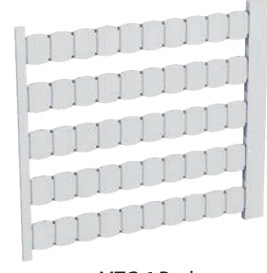

MTG 6 Baskısız

Ürün Kodu Product Code	Ürün Adı Product Name	Açıklama Description	Amb. Mik. Pack. Qty (Etiket - Tags / Pcs.)
8020388069	MTG 6 (101-150)	101-150	500
8020388079	MTG 6 (151-200)	151-200	500
8020388089	MTG 6 (201-250)	201-250	500
8020388099	MTG 6 (251-300)	251-300	500
8020388109	MTG 6 (301-350)	301-350	500
8020388119	MTG 6 (351-400)	351-400	500
8020388129	MTG 6 (401-450)	401-450	500
8020388139	MTG 6 (451-500)	451-500	500
8020388149	MTG 6 (501-550)	501-550	500
8020388159	MTG 6 (551-600)	551-600	500
8020388169	MTG 6 (601-650)	601-650	500
8020388179	MTG 6 (651-700)	651-700	500
8020388189	MTG 6 (701-750)	701-750	500
8020388199	MTG 6 (751-800)	751-800	500
8020388209	MTG 6 (801-850)	801-850	500
8020388219	MTG 6 (851-900)	851-900	500
8020388229	MTG 6 (901-950)	901-950	500
8020388239	MTG 6 (951-1000)	951-1000	500
8020388859	MTG 6 (RSTN)	RSTN	500
8020388779	MTG 6 (+)	+	500
8020388789	MTG 6 (-)	-	500
8020388429	MTG 6 (B)	B	500
8020388849	MTG 6 (PE)	PE	500
8020388459	MTG 6 (E)	E	500
8020388529	MTG 6 (L)	L	500
8020388549	MTG 6 (N)	N	500
8020388659	MTG 6 (Y)	Y	500
8020388589	MTG 6 (R)	R	500
8020388829	MTG 6 (L1, L2, L3)	L1, L2, L3	500
8020388799	MTG 6 (L1)	L1	500
8020388809	MTG 6 (L2)	L2	500
8020388499	MTG 6 (I)	I	500
8020388449	MTG 6 (D)	D	500
8020388519	MTG 6 (K)	K	500
8020388469	MTG 6 (F)	F	500
8020388419	MTG 6 (A)	A	500
8020388539	MTG 6 (M)	M	500
8020388569	MTG 6 (P)	P	500
8020388679	MTG 6 (X1)	X1	500
8020388689	MTG 6 (X2)	X2	500
8020388699	MTG 6 (X3)	X3	500
8020388709	MTG 6 (X4)	X4	500
8020388719	MTG 6 (X5)	X5	500
8020388729	MTG 6 (X6)	X6	500
8020388739	MTG 6 (X7)	X7	500
8020388749	MTG 6 (X8)	X8	500
8020388759	MTG 6 (X9)	X9	500
8020388769	MTG 6 (X10)	X10	500
8020388439	MTG 6 (C)	C	500
8020388629	MTG 6 (V)	V	500

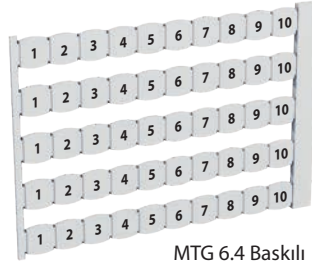

MTG 6.4 Baskılı

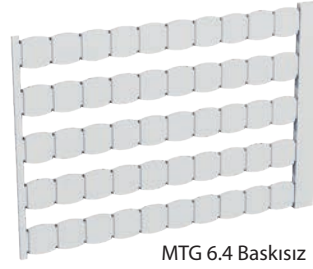

MTG 6.4 Baskısız

Ürün Kodu Product Code	Ürün Adı Product Name	Açıklama Description	Amb. Mik. Pack. Qty (Etiket - Tags / Pcs.)
8020388479	MTG 6 (G)	G	500
8020388489	MTG 6 (H)	H	500
8020388819	MTG 6 (L3)	L3	500
8020388869	MTG 6 (MP)	MP	500
8020388609	MTG 6 (T)	T	500
8020387019	MTG 6,4 Baskılı	Baskılı / Printed	500
8020387009	MTG 6,4 Baskısız	Boş / Empty	500
8020387309	MTG 6,4 (1)	1	500
8020387319	MTG 6,4 (2)	2	500
8020387329	MTG 6,4 (3)	3	500
8020387339	MTG 6,4 (4)	4	500
8020387349	MTG 6,4 (5)	5	500
8020387359	MTG 6,4 (6)	6	500
8020387369	MTG 6,4 (7)	7	500
8020387379	MTG 6,4 (8)	8	500
8020387389	MTG 6,4 (9)	9	500
8020387399	MTG 6,4 (10)	10	500
8020387030	MTG 6,4 (1-10)	1-10	500
8020387031	MTG 6,4 (11-20)	11-20	500
8020387032	MTG 6,4 (21-30)	21-30	500
8020387033	MTG 6,4 (31-40)	31-40	500
8020387034	MTG 6,4 (41-50)	41+50	500
8020387035	MTG 6,4 (51-60)	51-60	500
8020387036	MTG 6,4 (61-70)	61-70	500
8020387037	MTG 6,4 (71-80)	71-80	500
8020387038	MTG 6,4 (81-90)	81-90	500
8020387040	MTG 6,4 (91-100)	91-100	500
8020387029	MTG 6,4 (0-9)	0-9	500
8020387039	MTG 6,4 (1-50)	1-50	500
8020387049	MTG 6,4 (51-100)	51-100	500
8020387059	MTG 6,4 (101-150)	101-150	500
8020387069	MTG 6,4 (151-200)	151-200	500
8020387079	MTG 6,4 (201-250)	201-250	500
8020387089	MTG 6,4 (251-300)	251-300	500
8020387099	MTG 6,4 (301-350)	301-350	500
8020387109	MTG 6,4 (351-400)	351-400	500
8020387119	MTG 6,4 (401-450)	401-450	500
8020387129	MTG 6,4 (451-500)	451-500	500
8020387139	MTG 6,4 (501-550)	501-550	500
8020387149	MTG 6,4 (551-600)	551-600	500
8020387159	MTG 6,4 (601-650)	601-650	500
8020387169	MTG 6,4 (651-700)	651-700	500
8020387179	MTG 6,4 (701-750)	701-750	500
8020387189	MTG 6,4 (751-800)	751-800	500
8020387199	MTG 6,4 (801-850)	801-850	500
8020387209	MTG 6,4 (851-900)	851-900	500
8020387219	MTG 6,4 (901-950)	901-950	500
8020387229	MTG 6,4 (951-1000)	951-1000	500
8020387239	MTG 6,4 (1001-1050)	1001-1050	500
8020387249	MTG 6,4 (1051-1100)	1051-1100	500

## Klemens Etiketleri

### Marking Tags

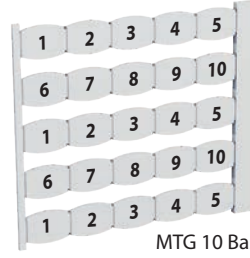

MTG 10 Baskılı

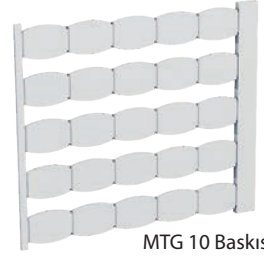

MTG 10 Baskısız

Ürün Kodu Product Code	Ürün Adı Product Name	Açıklama Description	Amb. Mik. Pack. Qty (Etiket - Tags / Pcs.)
8020386019	<b>MTG 8 Baskılı</b>	<b>Baskılı / Printed</b>	500
8020386009	<b>MTG 8 Baskısız</b>	<b>Boş / Empty</b>	500
8020386199	<b>MTG 8 (0)</b>	0	500
8020386209	<b>MTG 8 (1)</b>	1	500
8020386219	<b>MTG 8 (2)</b>	2	500
8020386229	<b>MTG 8 (3)</b>	3	500
8020386239	<b>MTG 8 (4)</b>	4	500
8020386249	<b>MTG 8 (5)</b>	5	500
8020386259	<b>MTG 8 (6)</b>	6	500
8020386269	<b>MTG 8 (7)</b>	7	500
8020386279	<b>MTG 8 (8)</b>	8	500
8020386289	<b>MTG 8 (9)</b>	9	500
8020386299	<b>MTG 8 (10)</b>	10	500
8020386309	<b>MTG 8 (0-9)</b>	0-9	500
8020386319	<b>MTG 8 (1-10)</b>	1-10	500
8020386029	<b>MTG 8 (1-50)</b>	1-50	500
8020386039	<b>MTG 8 (51-100)</b>	51-100	500
8020386049	<b>MTG 8 (101-150)</b>	101-150	500
8020386059	<b>MTG 8 (151-200)</b>	151-200	500
8020386069	<b>MTG 8 (201-250)</b>	201-250	500
8020386079	<b>MTG 8 (251-300)</b>	251-300	500
8020386089	<b>MTG 8 (301-350)</b>	301-350	500
8020386099	<b>MTG 8 (351-400)</b>	351-400	500
8020386109	<b>MTG 8 (401-450)</b>	401-450	500
8020386119	<b>MTG 8 (451-500)</b>	451-500	500
8020386169	<b>MTG 8 (701-750)</b>	701-750	500
8020386189	<b>MTG 8 (801-850)</b>	801-850	500
8020386329	<b>MTG 8 (+)</b>	+	500
8020386339	<b>MTG 8 (-)</b>	-	500
8020386349	<b>MTG 8 (PE)</b>	PE	500
8020386359	<b>MTG 8 (L)</b>	L	500
8020386369	<b>MTG 8 (N)</b>	N	500
8020386379	<b>MTG 8 (L1, L2, L3)</b>	L1, L2, L3	500
8020386389	<b>MTG 8 (L1)</b>	L1	500
8020386399	<b>MTG 8 (L2)</b>	L2	500
8020386409	<b>MTG 8 (L3)</b>	L3	500
8020385019	<b>MTG 10 Baskılı</b>	<b>Baskılı / Printed</b>	250
8020385009	<b>MTG 10 Baskısız</b>	<b>Boş / Empty</b>	250
8020385029	<b>MTG 10 (1)</b>	1	250
8020385039	<b>MTG 10 (2)</b>	2	250
8020385049	<b>MTG 10 (3)</b>	3	250
8020385059	<b>MTG 10 (4)</b>	4	250
8020385069	<b>MTG 10 (5)</b>	5	250
8020385079	<b>MTG 10 (6)</b>	6	250
8020385089	<b>MTG 10 (7)</b>	7	250
8020385099	<b>MTG 10 (8)</b>	8	250
8020385109	<b>MTG 10 (9)</b>	9	250
8020385119	<b>MTG 10 (10)</b>	10	250
8020385129	<b>MTG 10 (RSTN)</b>	RSTN	250
8020385139	<b>MTG 10 (L1)</b>	L1	250
8020385149	<b>MTG 10 (L2)</b>	L2	250
8020385159	<b>MTG 10 (L3)</b>	L3	250



## Montaj Rayları

Mounting Rails

Elektrolitik beyaz krom kaplanmış galvaniz çelik malzeme  
Electrolytic white chromated & galvanized steel material  
**EN 50022 EN 50035 IEC 60715**

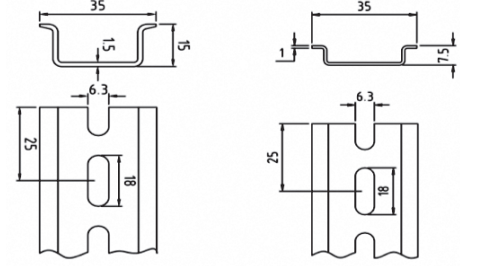

Ürün Kodu Product Code	Ürün Adı Product Name	Ölçüler / Dimensions (mm)			Açıklama Explanation	Birim Uzunluk Unit Length (m)	Ambalaj Miktarı Packing Qty (metre/meter)
		W	H	D			
8015393407	<b>DR 35-7,5 S 2M</b>	35	7,5	1	<b>Delikli Din Normu Ray / Slotted Din Rail</b>	2	40
8015393427	<b>DR 35-15 S 2M</b>	35	15	1,5	<b>Delikli Din Normu Ray / Slotted Din Rail</b>	2	20

## Eko Seri Montaj Rayları

Economical Range Mounting Rails

Ürün Kodu Product Code	Ürün Adı Product Name	Ölçüler / Dimensions (mm)			Açıklama Explanation	Birim Uzunluk Unit Length (m)	Ambalaj Miktarı Packing Qty (metre/meter)
		W	H	D			
8015393447	<b>DR 35-7,5 E 2M</b>	35	7,5	0,9	<b>Delikli Ray / Slotted Rail</b>	2	50

## Ray Taşıyıcılar

Rail Supports

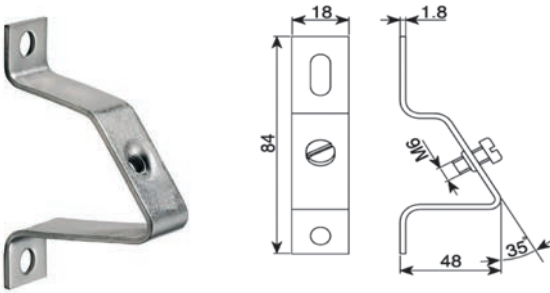

Ürün Kodu Product Code	Ürün Adı Product Name	Açıklama Explanation	Delik Çapı Dia. Hole	Ambalaj Miktarı Packing Qty (Adet/pcs.)
8015393507	<b>ART - M6</b>	<b>35° Açılı Ray Taşıyıcı</b> 35° Angeled Rail Support	M6	50

## Ray Kapağı

Rail Cover



Ürün Kodu Product Code	Ürün Adı Product Name	Açıklama Explanation	Ambalaj Miktarı Packing Qty (Adet/pcs.)
8015393537	<b>C-DR 7,5</b>	<b>Ray Kenar Kapağı</b> Rail Cover	200
8015393547	<b>C-DR 15</b>		100

## Kanal Kesme Makası

Wiring Duct Cutter



WDC 125

Ürün Kodu Product Code	Ürün Adı Product Name	Açıklama Explanation	Ambalaj Miktarı Packing Qty (Adet/pcs.)
8019391300	WDC 125	125 mm genişliğe kadar kablo kanalları için Düz kesim tezgah üstü makas. Flat-cut Table-top type cutter up to 120 mm duct width	1

## Ray Kesme Makası

Din Rail Cutters



DRC 2W8R

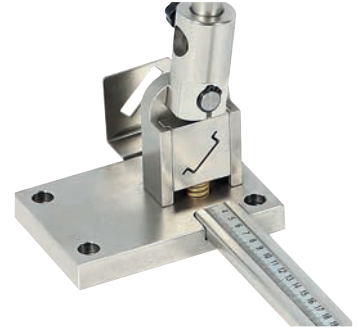

DRC 1W

Ürün Kodu Product Code	Ürün Adı Product Name	Açıklama Explanation	Ambalaj Miktarı Packing Qty (Adet/pcs.)
8015393557	DRC 1W	35x7.5 raya uygun, 1.5 mm kalınlığa kadar kesim, 1 gözlü tezgah üstü makas. 1 way table-top type cutter for 35x7.5 Din Rail, up to 1.5 mm thickness	1
8015393567	DRC 2W8R	35x7.5, 35x15 raya ve 8 mm Tij kesimine uygun, 3 gözlü tezgah üstü makas. 3 way table-top type cutter for 35x7.5, 35x15 Din Rails and 8 mm Rod	1

## Pano Tipi Delikli Kablo Kanalları

### Panel Type Slotted Wiring Ducts

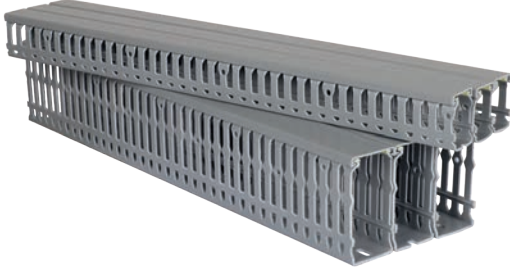

Ürün Kodu Product Code	Ürün Adı Product Name	Ölçüler / Dimensions (mm)		Renk Color	Ambalaj Miktarı Packing Qty (metre/meter)
		W	H		
8019391008	<b>SWD 25x40 Pano Tipi Kablo Kanalı</b> / Panel Type Slotted Wiring Ducts	25	40	<b>Gri</b> / Gray	60
8019391018	<b>SWD 25x60 Pano Tipi Kablo Kanalı</b> / Panel Type Slotted Wiring Ducts	25	60	<b>Gri</b> / Gray	40
8019391318	<b>SWD 25x80 Pano Tipi Kablo Kanalı</b> / Panel Type Slotted Wiring Ducts	25	80	<b>Gri</b> / Gray	20
8019391028	<b>SWD 40x40 Pano Tipi Kablo Kanalı</b> / Panel Type Slotted Wiring Ducts	40	40	<b>Gri</b> / Gray	40
8019391038	<b>SWD 40x60 Pano Tipi Kablo Kanalı</b> / Panel Type Slotted Wiring Ducts	40	60	<b>Gri</b> / Gray	36
8019391048	<b>SWD 40x80 Pano Tipi Kablo Kanalı</b> / Panel Type Slotted Wiring Ducts	40	80	<b>Gri</b> / Gray	28
8019391058	<b>SWD 60x40 Pano Tipi Kablo Kanalı</b> / Panel Type Slotted Wiring Ducts	60	40	<b>Gri</b> / Gray	32
8019391068	<b>SWD 60x60 Pano Tipi Kablo Kanalı</b> / Panel Type Slotted Wiring Ducts	60	60	<b>Gri</b> / Gray	24
8019391078	<b>SWD 60x80 Pano Tipi Kablo Kanalı</b> / Panel Type Slotted Wiring Ducts	60	80	<b>Gri</b> / Gray	16
8019391088	<b>SWD 80x60 Pano Tipi Kablo Kanalı</b> / Panel Type Slotted Wiring Ducts	80	60	<b>Gri</b> / Gray	20
8019391098	<b>SWD 80x80 Pano Tipi Kablo Kanalı</b> / Panel Type Slotted Wiring Ducts	80	80	<b>Gri</b> / Gray	16
8019391108	<b>SWD 80x100 Pano Tipi Kablo Kanalı</b> / Panel Type Slotted Wiring Ducts	80	100	<b>Gri</b> / Gray	8
8019391118	<b>SWD 100x60 Pano Tipi Kablo Kanalı</b> / Panel Type Slotted Wiring Ducts	100	60	<b>Gri</b> / Gray	12
8019391128	<b>SWD 100x80 Pano Tipi Kablo Kanalı</b> / Panel Type Slotted Wiring Ducts	100	80	<b>Gri</b> / Gray	8
8019391138	<b>SWD 100x100 Pano Tipi Kablo Kanalı</b> / Panel Type Slotted Wiring Ducts	100	100	<b>Gri</b> / Gray	8

## Kablo Kanal Kapakları

### Wiring Duct Covers

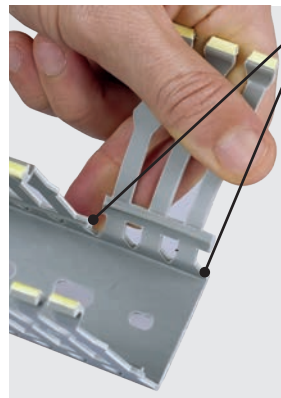
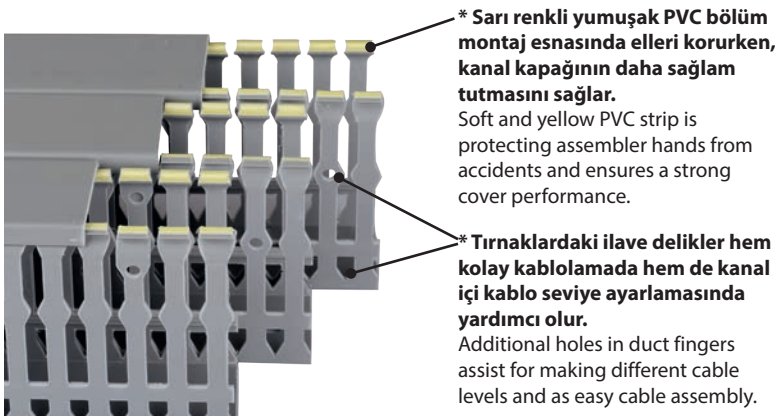

Ürün Kodu Product Code	Ürün Adı Product Name	En Width (mm.)	Boy Length (m.)	Renk Color	Ambalaj Miktarı Packing Qty (metre/meter)
8019391208	<b>SWC 25 Kapak</b> / Wiring Duct Covers	20	2	<b>Gri</b> / Gray	40
8019391218	<b>SWC 40 Kapak</b> / Wiring Duct Covers	40	2	<b>Gri</b> / Gray	40
8019391228	<b>SWC 60 Kapak</b> / Wiring Duct Covers	60	2	<b>Gri</b> / Gray	40
8019391238	<b>SWC 80 Kapak</b> / Wiring Duct Covers	80	2	<b>Gri</b> / Gray	20
8019391248	<b>SWC 100 Kapak</b> / Wiring Duct Covers	100	2	<b>Gri</b> / Gray	20

## Pano Tipi Delikli Kablo Kanalları Teknik Bilgiler

### Panel Type Slotted Wiring Ducts Technical Information

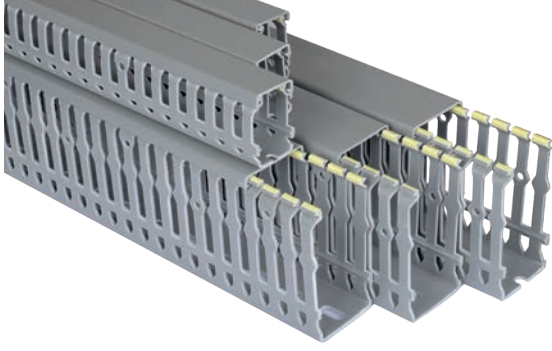

Ürün Kodu Product Code	Ürün Adı Product Name	Ölçüler / Dimensions (mm)						Ölçülmüş Toplam Kesit Measured Total Cross Sec. (mm <sup>2</sup> )	İletken Dolum Kapasitesi (%60 oran için) Wire Filling Capacity (for 60% ratio)		
		W	H	E	F	G	Ø		2,5 mm <sup>2</sup>	1,5 mm <sup>2</sup>	1,0 mm <sup>2</sup>
8019391008	SWD 25x40	25	40	6,5	5,9	12,8	4,5	820	35	51	78
8019391018	SWD 25x60	25	60	6,5	6	15,7	4,5	1.190	57	83	112
8019391318	SWD 25x80	25	80	6,5	6	19,8	4,5	1.680	82	116	155
8019391028	SWD 40x40	40	40	6,5	5,9	12,8	4,5	1.360	65	94	129
8019391038	SWD 40x60	40	60	6,5	6	15,7	4,5	2.040	98	141	192
8019391048	SWD 40x80	40	80	6,5	6	19,8	4,5	2.700	130	187	255
8019391058	SWD 60x40	60	40	6,5	5,9	12,8	4,5	1.970	95	134	188
8019391068	SWD 60x60	60	60	6,5	6	15,7	4,5	3.080	148	214	291
8019391078	SWD 60x80	60	80	6,5	6	19,8	4,5	4.140	200	289	392
8019391088	SWD 80x60	80	60	6,5	6	15,7	4,5	4.150	200	288	391
8019391098	SWD 80x80	80	80	6,5	6	19,8	4,5	5.660	272	393	534
8019391108	SWD 80x100	80	100	6,5	6	19,8	4,5	6.620	329	472	644
8019391118	SWD 100x60	100	60	6,5	6	15,7	4,5	5.250	254	364	491
8019391128	SWD 100x80	100	80	6,5	6	19,8	4,5	7.606	255	418	702
8019391138	SWD 100x100	100	100	6,5	6	19,8	4,5	8.920	430	619	812

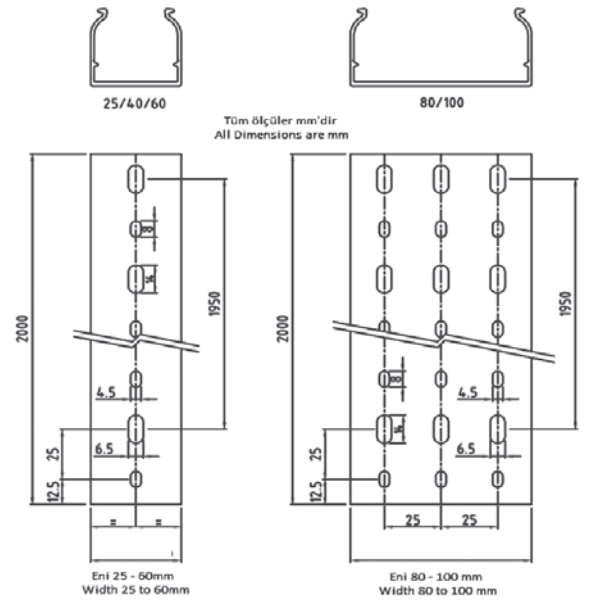
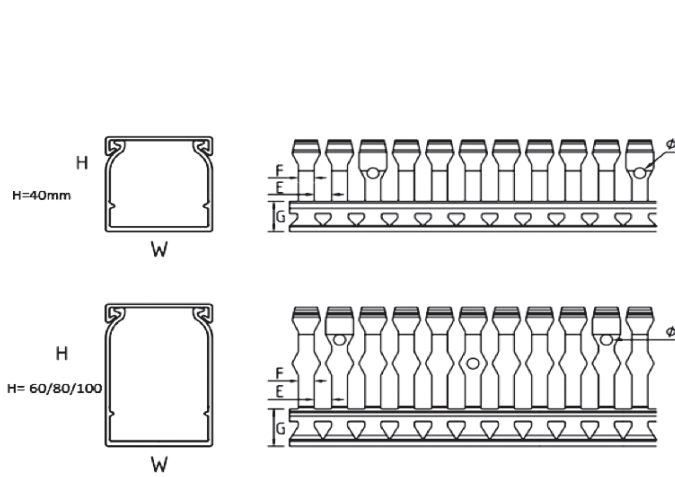

• Kanallar ve kapaklar 2 mt. lik boyda kesilmiş ve paketlenmiştir.

• Wiring ducts and covers are cut and packed in 2 m length.

## Markalama Sistemleri

Marking Systems



## Termal Transfer Yazıcı

Thermal Transfer Printer



Ürün Kodu Product Code	Ürün Adı Product Name	Amb. Mik. Pack. Qty. (Ad./Pcs.)
8030129000	<b>TBL TP2 Termal Yazıcı / Thermal Printer</b>	1

## Ribonlar

Ribbons



Ürün Kodu Product Code	Ürün Adı Product Name	İç Çap Inner Diameter (mm)	Ölçüler Dimensions (mmxm)	Renk Color	Amb. Mik. Pack. Qty. (Ad./Pcs.)
8030129120	<b>RR Ribbon 50x300</b>	25,4 (1 inch)	50x300	<b>Siyah / Black</b>	1
8030129130	<b>RR Ribbon 110x300</b>	25,4 (1 inch)	110x300	<b>Siyah / Black</b>	1

## Klemensler için Şerit Etiket

Terminal Blocks Strip Label

Ürün Kodu Product Code	Ürün Adı Product Name	Ölçüler Dimensions (mmxm)	Renk Color	Rulo Etiket Labels Roll	Amb. Mik. Pack. Qty. (Ad./Pcs.)
8020384009	<b>TBSL 22x20</b>	22x20	<b>Beyaz White</b>	<b>2 sıra Şerit Etiket</b> 2 pcs. of Strip Label	1
8020384011	<b>TBSL 5,15x5</b>	25,75x20	<b>Beyaz White</b>	<b>5 sıra Şerit Etiket</b> 5 pcs. of Strip Label	1



TBSL 22x20



## Kablo İşaretleme Plakaları (Şeffaf Tüpler için)

Cable Marking Plates (for Transparent Sleeves)

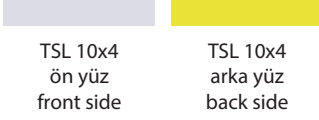

Ürün Kodu Product Code	Ürün Adı Product Name	Yazım Alanı Print Area (mm)	Açıklama Explanation	Amb. Mik. Pack. Qty. (Ad./Pcs.)
8021340004	TSL 10x4 Sarı - Beyaz / Yellow - White	10 x 4	Katlamalı Folded	3.000
8021340104	TSL 12x4 Sarı - Beyaz / Yellow - White	12 x 4	Katlamalı Folded	3.000
8021340014	TSL 15x4 Sarı - Beyaz / Yellow - White	15 x 4	Katlamalı Folded	3.000
8021340024	TSL 20x4 Sarı - Beyaz / Yellow - White	20 x 4	Katlamalı Folded	3.000
8021340034	TSL 30x4 Sarı - Beyaz / Yellow - White	30 x 4	Katlamalı Folded	3.000

## Şeffaf Tüpler

Transparent Sleeves - Closed / Insertion Type



TS 10 1,5-2,5



TS 10 2,5-4,0



TS 10 6,0-10



TS 10 16-25

Ürün Kodu Product Code	Ürün Adı Product Name	Uzunluk Length (mm)	Renk Color	İletken Kesit Cond. Cross Sec. (mm <sup>2</sup> )	Amb. Mik. Pack. Qty. (Ad./Pcs.)
8021343019	TS 10 1,5-2,5	10	Şeffaf / Transparent	1,5 - 2,5	500
8021343029	TS 12 1,5-2,5	12	Şeffaf / Transparent	1,5 - 2,5	500
8021343039	TS 15 1,5-2,5	15	Şeffaf / Transparent	1,5 - 2,5	500
8021343049	TS 20 1,5-2,5	20	Şeffaf / Transparent	1,5 - 2,5	500
8021343059	TS 30 1,5-2,5	30	Şeffaf / Transparent	1,5 - 2,5	500
8021344019	TS 10 2,5-4,0	10	Şeffaf / Transparent	2,5 - 4	500
8021344029	TS 12 2,5-4,0	12	Şeffaf / Transparent	2,5 - 4	500
8021344039	TS 15 2,5-4,0	15	Şeffaf / Transparent	2,5 - 4	500
8021344049	TS 20 2,5-4,0	20	Şeffaf / Transparent	2,5 - 4	500
8021344059	TS 30 2,5-4,0	30	Şeffaf / Transparent	2,5 - 4	500
8021345019	TS 10 6,0-10	10	Şeffaf / Transparent	6 - 10	500
8021345029	TS 12 6,0-10	12	Şeffaf / Transparent	6 - 10	500
8021345039	TS 15 6,0-10	15	Şeffaf / Transparent	6 - 10	500
8021345049	TS 20 6,0-10	20	Şeffaf / Transparent	6 - 10	500
8021345059	TS 30 6,0-10	30	Şeffaf / Transparent	6 - 10	500
8021346019	TS 10 16-25	10	Şeffaf / Transparent	16 - 25	500
8021346029	TS 12 16-25	12	Şeffaf / Transparent	16 - 25	500
8021346039	TS 15 16-25	15	Şeffaf / Transparent	16 - 25	500
8021346049	TS 20 16-25	20	Şeffaf / Transparent	16 - 25	200
8021346059	TS 30 16-25	30	Şeffaf / Transparent	16 - 25	200

## İnce Yapışkanlı Etiketler (Pano Yüzeyi, Kontaktör ve Pano İçi Diğer Cihazlar için)

Slim Adhesive Labels (For Panel Surface, Contactors and Other Devices Inside Panel)

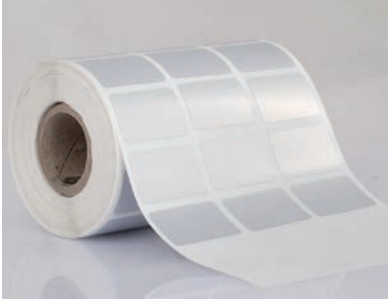

SPEL 27x15



SPEL 35x15



SPEL 15x6

Ürün Kodu Product Code	Ürün Adı Product Name	Yazım Alanı Print Area (mm)	Renk Color	Amb. Mik. Pack. Qty. (Ad./Pcs.)
8022120004	SPEL 12x9	12x9	Sarı / Yellow	2.500
8022120008	SPEL 12x9	12x9	Gümüş / Silver	2.500
8022120009	SPEL 12x9	12x9	Beyaz / White	2.500
8022120014	SPEL 15x6	15x6	Sarı / Yellow	2.500
8022120018	SPEL 15x6	15x6	Gümüş / Silver	2.500
8022120019	SPEL 15x6	15x6	Beyaz / White	2.500
8022120024	SPEL 15x9	15x9	Sarı / Yellow	2.500
8022120028	SPEL 15x9	15x9	Gümüş / Silver	2.500
8022120029	SPEL 15x9	15x9	Beyaz / White	2.500
8022120034	SPEL 17x10	17x10	Sarı / Yellow	2.500
8022120038	SPEL 17x10	17x10	Gümüş / Silver	2.500
8022120039	SPEL 17x10	17x10	Beyaz / White	2.500
8022120044	SPEL 18x8	18x8	Sarı / Yellow	2.500
8022120048	SPEL 18x8	18x8	Gümüş / Silver	2.500
8022120049	SPEL 18x8	18x8	Beyaz / White	2.500
8022120054	SPEL 27x12,5	27x12	Sarı / Yellow	2.500
8022120058	SPEL 27x12,5	27x12	Gümüş / Silver	2.500
8022120059	SPEL 27x12,5	27x12	Beyaz / White	2.500
8022120064	SPEL 27x15	27x15	Sarı / Yellow	2.500
8022120068	SPEL 27x15	27x15	Gümüş / Silver	2.500
8022120069	SPEL 27x15	27x15	Beyaz / White	2.500
8022120074	SPEL 27x18	27x18	Sarı / Yellow	2.500
8022120078	SPEL 27x18	27x18	Gümüş / Silver	2.500
8022120079	SPEL 27x18	27x18	Beyaz / White	2.500
8022120098	SPEL 35x18	35x18	Gümüş / Silver	1.500
8022120108	SPEL 45x15	45x15	Gümüş / Silver	2.000
8022120118	SPEL 70x30	70x30	Gümüş / Silver	250
8022120128	SPEL 90x40	90x40	Gümüş / Silver	250
8022120138	SPEL 100x50	100x50	Gümüş / Silver	250



## Kalın Yapışkanlı Etiketler (Pano Yüzeyi için)

Thick Adhesive Labels (For Panel Surface)



TPEL 40x30

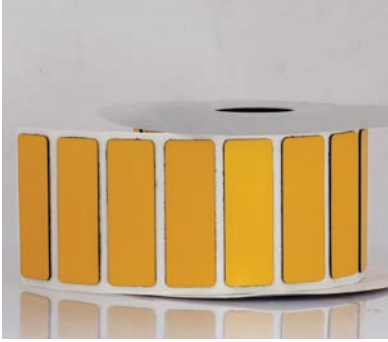

TPEL 60x15



TPEL 45x15

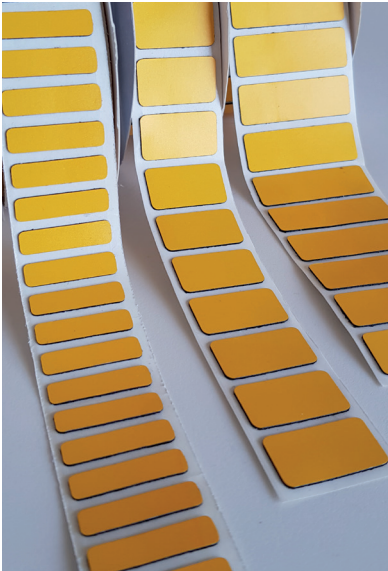

Ürün Kodu Product Code	Ürün Adı Product Name	Yazım Alanı Print Area (mm)	Renk Color	Amb. Mik. Pack. Qty. (Ad./Pcs.)
8022130014	TPEL 22x22	22x22	Sarı / Yellow	150
8022130018	TPEL 22x22	22x22	Gümüş / Silver	150
8022130019	TPEL 22x22	22x22	Beyaz / White	150
8022130004	TPEL 27x12,5	27x12	Sarı / Yellow	150
8022130008	TPEL 27x12,5	27x12	Gümüş / Silver	150
8022130009	TPEL 27x12,5	27x12	Beyaz / White	150
8022130024	TPEL 27x15	27x15	Sarı / Yellow	150
8022130028	TPEL 27x15	27x15	Gümüş / Silver	150
8022130029	TPEL 27x15	27x15	Beyaz / White	150
8022130109	TPEL 27x18	27x18	Sarı / Yellow	150
8022130108	TPEL 27x18	27x18	Gümüş / Silver	150
8022130104	TPEL 27x18	27x18	Beyaz / White	150
8022130034	TPEL 27x27	27x27	Sarı / Yellow	150
8022130038	TPEL 27x27	27x27	Gümüş / Silver	150
8022130039	TPEL 27x27	27x27	Beyaz / White	150
8022130044	TPEL 35x18	35x18	Sarı / Yellow	150
8022130048	TPEL 35x18	35x18	Gümüş / Silver	150
8022130049	TPEL 35x18	35x18	Beyaz / White	150
8022130054	TPEL 40x30	40x30	Sarı / Yellow	125
8022130058	TPEL 40x30	40x30	Gümüş / Silver	125
8022130059	TPEL 40x30	40x30	Beyaz / White	125
8022130064	TPEL 45x15	45x15	Sarı / Yellow	150
8022130068	TPEL 45x15	45x15	Gümüş / Silver	150
8022130069	TPEL 45x15	45x15	Beyaz / White	150
8022130074	TPEL 60x15	60x15	Sarı / Yellow	150
8022130078	TPEL 60x15	60x15	Gümüş / Silver	150
8022130079	TPEL 60x15	60x15	Beyaz / White	150
8022130084	TPEL 60x30	60x30	Sarı / Yellow	125
8022130088	TPEL 60x30	60x30	Gümüş / Silver	125
8022130089	TPEL 60x30	60x30	Beyaz / White	125
8022130094	TPEL 90x45	90x45	Sarı / Yellow	50
8022130098	TPEL 90x45	90x45	Gümüş / Silver	50
8022130099	TPEL 90x45	90x45	Beyaz / White	50





## Buton Etiketleri (22 mm Çapa Uygun)

Push Button Labels (Suitable for 22 mm Diameter)



TPBL 30x40



Ürün Kodu Product Code	Ürün Adı Product Name	Yazım Alanı Print Area (mm)	Renk Color	Delik Çapı Hole Dia. (mm)	Amb. Mik. Pack. Qty. (Ad./Pcs.)
8022130114	TPBL 30x40	30 x 13	Sarı / Yellow	23,5	100
8022130118	TPBL 30x40	30 x 13	Gümüş / Silver	23,5	100
8022130119	TPBL 30x40	30 x 13	Beyaz / White	23,5	100



TPBL 30x40

## Buton Etiket Tutucular (22 mm Çapa Uygun)

Push Button Labels (Suitable for 22 mm Diameter)



TBET 50X30

TBET 40X30

Ürün Kodu Product Code	Ürün Adı Product Name	Yazım Alanı Print Area (mm)	Renk Color	Amb. Mik. Pack. Qty. (Ad./Pcs.)
8022130330	TBET 40x30	25 x 8	Siyah / Black	60
8022130340	TBET 50x30	25 x 18	Siyah / Black	60

## Yapışkanlı Pano Etiket Tutucular

Self Adhesive Panel Labels Holders



TYPET 17x75



TYPET 17x50



TYPET 17x30

Ürün Kodu Product Code	Ürün Adı Product Name	Yazım Alanı Print Area (mm)	Renk Color	Amb. Mik. Pack. Qty. (Ad./Pcs.)
8022130300	TYPET 17x30	27 x 14	Siyah / Black	100
8022130310	TYPET 17x50	49 x 15	Siyah / Black	50
8022130320	TYPET 17x75	72 x 15	Siyah / Black	25

**Boş yazım kağıtları paketin içerisinde.**  
Empty printing papers are inside the package



## Klemens Grup Etiketleri için Etiketler

Labels for Terminal Blocks Group Markers

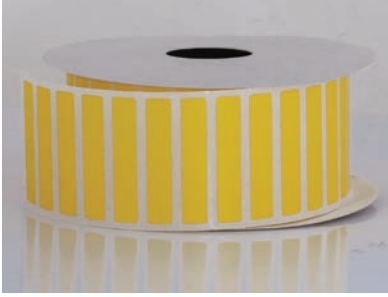

GML 2 36x7

Ürün Kodu Product Code	Ürün Adı Product Name	Yazım Alanı Print Area (mm)	Renk Color	Uyumlu Ürün Explanation	Amb. Mik. Pack. Qty. (Ad./Pcs.)
8022130124	<b>GML 1 36x17</b>	36 x 17	<b>Sarı / Yellow</b>	GM 1	2.000
8022130134	<b>GML 2 36x7</b>	36 x 7	<b>Sarı / Yellow</b>	GM 2	2.000



## Yapışkanlı Bant Etiketler

Self Adhesive Endless Labels



SALT 5x20

Ürün Kodu Product Code	Ürün Adı Product Name	Ölçüler Dimensions (mmxmm)	Renk Color	Amb. Mik. Pack. Qty. (Ad./Pcs.)
8022130144	<b>SALT 5x20</b>	50 x 20	<b>Sarı / Yellow</b>	1
8022130128	<b>SALT 5x20</b>	50 x 20	<b>Gümüş / Silver</b>	1
8022130129	<b>SALT 5x20</b>	50 x 20	<b>Beyaz / White</b>	1

## Acil Stop Etiketleri (22mm Çapa Uygun)

Emergency Stop Labels (Suitable for 22mm Diameter)



Ürün Kodu Product Code	Ürün Adı Product Name	Etiket Çapı Label Dia. (mm)	Delik Çapı Hole Dia. (mm)	Renk Color	Amb. Mik. Pack. Qty. (Ad./Pcs.)
8022130350	<b>ASE60</b>	60	23,5	<b>Sarı / Yellow</b>	1

## Kablo Bağı ile Bağlanan Etiketler (Doğrudan Kablo Bağına Takılan)

Labels Assembled with Cable Ties (Directly Assembled to Cable Ties)



RCTL 50x15

HCTL 25x10

Ürün Kodu Product Code	Ürün Adı Product Name	Yazım Alanı Print Area (mm)	Renk Color	Açıklama Explanation	Amb. Mik. Pack. Qty. (Ad./Pcs.)
8021341019	HCTL 25x10	25 x 10	Beyaz / White	Altıgen / Hexagonal	250
8021342019	RCTL 25x10	25 x 10	Beyaz / White	Dikdörtgen / Rectangular	250
8021342029	RCTL 50x15	50 x 15	Beyaz / White	Dikdörtgen / Rectangular	250
8021342039	RCTL 60x30	60 x 30	Beyaz / White	Dikdörtgen / Rectangular	250

## Kablo Bağı ile Bağlanan Etiketler (Etiket Kılıfıyla Bağlananlar )

Labels Assembled with Cable Ties (Assembled with Label Holder)

Ürün Kodu Product Code	Ürün Adı Product Name	Yazım Alanı Print Area (mm)	Renk Color	Açıklama Explanation	Amb. Mik. Pack. Qty. (Ad./Pcs.)
8021334009	CM 1		Beyaz / White	Etiket Kılıfı 1 / Label Holder 1	100
8021334019	CM 2		Beyaz / White	Etiket Kılıfı 2 / Label Holder 2	100

**Boş yazım kağıtları paketin içerisinde.**  
Empty printing papers are inside the package

Ürün Kodu Product Code	Ürün Adı Product Name	Renk Color	Ölçüler / Dimensions		
			L	W	T
8021334009	CM 1	Beyaz / White	35	10	8
8021334019	CM 2	Beyaz / White	45	20	8

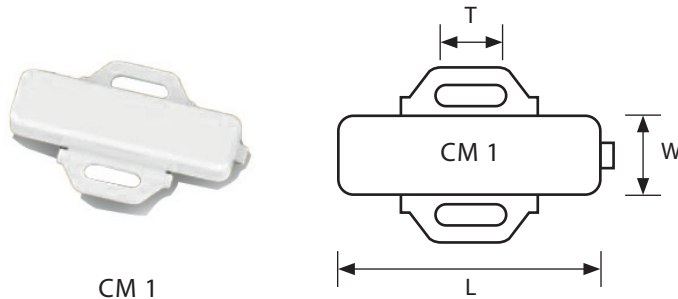

CM 1

## Paslanmaz Çelik Kablo Bağları - 304 Kalite

Stainless Steel Cable Ties - Grade 304



Ürün Kodu Product Code	Ürün Adı Product Name	Ölçüler (BoyxEn) Dimensions (LxW) (mm)	Maks. Sıkma Çapı Max. Bundle Dia. (mm)	Min. Açılma Mukavemeti Min. Loop Tensile Strenght (kg.)	Amb. Mik. Pack. Qty (Adet/Pcs.)	Koli Mik. Carton Qty. (Adet/Pcs.)
8016335010	<b>SSCT 150x4.6</b>	150x4.6	33	55	100	8.000
8016335020	<b>SSCT 200x4.6</b>	200x4.6	50	55	100	6.000
8016335030	<b>SSCT 250x4.6</b>	250x4.6	67	55	100	5.000
8016335040	<b>SSCT 300x4.6</b>	300x4.6	75	55	100	5.000
8016335050	<b>SSCT 370x4.6</b>	370x4.6	102	55	100	4.000
8016335060	<b>SSCT 450x4.6</b>	450x4.6	130	55	100	3.000
8016335070	<b>SSCT 520x4.6</b>	520x4.6	152	55	100	3.000
8016335080	<b>SSCT 680x4.6</b>	680x4.6	203	55	100	2.000
8016335090	<b>SSCT 840x4.6</b>	840x4.6	254	55	100	1.000
8016335100	<b>SSCT 200x7.9</b>	200x7.9	50	120	100	5.000
8016335110	<b>SSCT 300x7.9</b>	300x7.9	75	120	100	4.000
8016335120	<b>SSCT 370x7.9</b>	370x7.9	102	120	100	3.000
8016335130	<b>SSCT 450x7.9</b>	450x7.9	130	120	100	3.000
8016335140	<b>SSCT 520x7.9</b>	520x7.9	152	120	100	2.000
8016335150	<b>SSCT 680x7.9</b>	680x7.9	203	120	100	2.000
8016335160	<b>SSCT 840x7.9</b>	840x7.9	254	120	100	1.000
8016335170	<b>SSCT 1000x7.9</b>	1000x7.9	305	120	100	1.000



## Teknik Özellikler

Technical Futures

<b>Malzeme</b> / Material	<b>304 kalite Paslanmaz Çelik</b> / 304 grade Stainless Steel
<b>Su Emilimi</b> / Water Absorption	<b>Yok</b> / No
<b>Alev Yürümeme</b> / Flame Retardant	<b>UL94V-2</b>
<b>UV Dayanıklılığı</b> / UV Resistance	<b>Mükemmel</b> / Excellent
<b>Kimyasal Dayanım</b> / Chemical Resistance	<b>Mükemmel</b> / Excellent
<b>Çalışma Sıcaklığı</b> / Operating Temperature	<b>-80°C + 538°C</b>

## Müşterek w otomat baraları

Pin mcb busbars

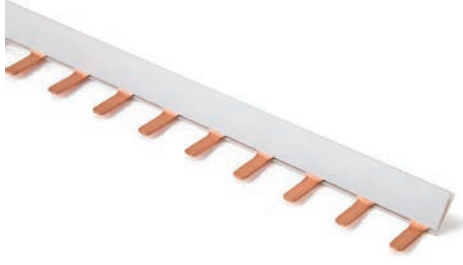

## Monofaze W Otomat Baraları

Singlephase MCB Busbars

Ürün Kodu Product Code	Ürün Adı Product Name	Akım Current (A)	Bara Kalınlığı Busbar Thickness (mm)	Uzunluk Length (cm.)	Modül Sayısı Module Number	Ambalaj Mik. Pack. Qty. (TL/Ad.)
8034110010	<b>MJAB80-1x53</b>	80	1	53	30	50
8034110020	<b>MJAB80-1x106</b>	80	1	106	60	50
8034110030	<b>MJAB100-1,5x53</b>	100	1.5	53	30	50
8034110040	<b>MJAB100-1,5x106</b>	100	1.5	106	60	50

## Trifaze W Otomat Baraları

Threephases MCB Busbars

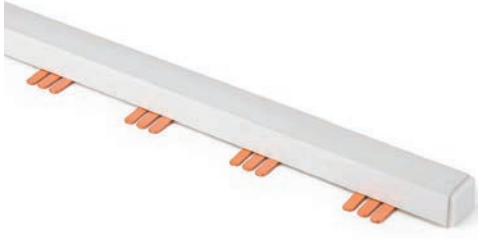

Ürün Kodu Product Code	Ürün Adı Product Name	Akım Current (A)	Bara Kalınlığı Busbar Thickness (mm)	Uzunluk Length (cm.)	Modül Sayısı Module Number	Ambalaj Mik. Pack. Qty. (TL/Ad.)
8034330010	<b>TJAB63- 1x53</b>	63	1	53	10	25
8034330020	<b>TJAB63- 1x106</b>	63	1	106	20	25
8034330030	<b>TJAB80- 1x53</b>	80	1	53	10	25
8034330040	<b>TJAB80- 1x106</b>	80	1	106	20	25
8034330050	<b>TJAB100-1,5x53</b>	100	1.5	53	10	25
8034330060	<b>TJAB100-1,5x106</b>	100	1.5	106	20	25

Ürün Kodu Product Code	Ürün Adı Product Name	Ambalaj Mik. Pack. Qty. (TL/Ad.)
8034110009	<b>MCB Monofaze otomat barasi kapagi / Singlephase mcb busbar side covers</b>	500
8034330009	<b>TCB Trifaze otomat barasi kapagi / Threephases mcb busbar side covers</b>	500

## Plastik Kablo Bağları

Plastic Cable Ties

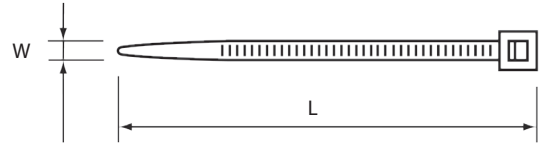
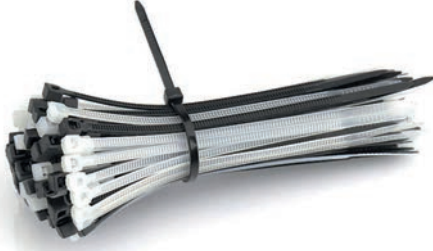

Ürün Kodu Product Code	Ürün Adı Product Name	Ölçüler (BoyxEn) Dimensions (LxW) (mm)	Maks. Sıkma Çapı Max. Bundle Dia. (mm)	Min. Açılma Mukavemeti Min. Loop Tensile Strength (kg.)	Amb. Mik. Pack. Qty (Adet/Pcs.)	Koli Mik. Carton Qty. (Adet/Pcs.)
8016330109	PCT 100 x 2.5 Beyaz / White	100 x 2.5	22	8	100	26.000
8016330110	PCT 100 x 2.5 Siyah / Black	100 x 2.5	22	8	100	26.000
8016330209	PCT 150 x 2.5 Beyaz / White	150 x 2.5	35	8	100	20.000
8016330210	PCT 150 x 2.5 Siyah / Black	150 x 2.5	35	8	100	20.000
8016330309	PCT 200 x 2.5 Beyaz / White	200 x 2.5	55	8	100	18.000
8016330310	PCT 200 x 2.5 Siyah / Black	200 x 2.5	55	8	100	18.000
8016330409	PCT 140 x 3.6 Beyaz / White	140 x 3.6	36	18	100	12.000
8016330410	PCT 140 x 3.6 Siyah / Black	140 x 3.6	36	18	100	12.000
8016330509	PCT 200 x 3.6 Beyaz / White	200 x 3.6	52	18	100	10.000
8016330510	PCT 200 x 3.6 Siyah / Black	200 x 3.6	52	18	100	10.000
8016330609	PCT 250 x 3.6 Beyaz / White	250 x 3.6	68	18	100	8.000
8016330610	PCT 250 x 3.6 Siyah / Black	250 x 3.6	68	18	100	8.000
8016330709	PCT 280 x 3.6 Beyaz / White	280 x 3.6	82	18	100	8.000
8016330710	PCT 280 x 3.6 Siyah / Black	280 x 3.6	82	18	100	8.000
8016330809	PCT 370 x 3.6 Beyaz / White	370 x 3.6	105	18	100	6.000
8016330810	PCT 370 x 3.6 Siyah / Black	370 x 3.6	105	18	100	6.000
8016331009	PCT 200 x 4.8 Beyaz / White	200 x 4.8	49	22	100	7.000
8016331010	PCT 200 x 4.8 Siyah / Black	200 x 4.8	49	22	100	7.000
8016331209	PCT 250 x 4.8 Beyaz / White	250 x 4.8	68	22	100	6.000
8016331210	PCT 250 x 4.8 Siyah / Black	250 x 4.8	68	22	100	6.000
8016331309	PCT 300 x 4.8 Beyaz / White	300 x 4.8	83	22	100	5.000
8016331310	PCT 300 x 4.8 Siyah / Black	300 x 4.8	83	22	100	5.000
8016331509	PCT 370 x 4.8 Beyaz / White	370 x 4.8	105	22	100	4.000
8016331510	PCT 370 x 4.8 Siyah / Black	370 x 4.8	105	22	100	4.000
8016331709	PCT 430 x 4.8 Beyaz / White	430 x 4.8	125	22	100	3.000
8016331710	PCT 430 x 4.8 Siyah / Black	430 x 4.8	125	22	100	3.000
8016332009	PCT 300 x 7.6 Beyaz / White	300 x 7.6	80	55	100	3.000
8016332010	PCT 300 x 7.6 Siyah / Black	300 x 7.6	80	55	100	3.000
8016332209	PCT 370 x 7.6 Beyaz / White	370 x 7.6	101	55	100	2.500
8016332210	PCT 370 x 7.6 Siyah / Black	370 x 7.6	101	55	100	2.500
8016332309	PCT 450 x 7.6 Beyaz / White	450 x 7.6	128	55	100	2.500
8016332310	PCT 450 x 7.6 Siyah / Black	450 x 7.6	128	55	100	2.500
8016332329	PCT 550 x 7.6 Beyaz / White	550 x 7.6	155	55	100	1.500
8016332320	PCT 550 x 7.6 Siyah / Black	550 x 7.6	155	55	100	1.500
8016332339	PCT 750 x 7.6 Beyaz / White	750 x 7.6	220	55	100	1.200
8016332330	PCT 750 x 7.6 Siyah / Black	750 x 7.6	220	55	100	1.200
8016332409	PCT 600 x 9.0 Beyaz / White	600 x 9.0	160	80	100	1.200
8016332410	PCT 600 x 9.0 Siyah / Black	600 x 9.0	160	80	100	1.200
8016332609	PCT 760 x 9.0 Beyaz / White	760 x 9.0	227	80	100	1.200
8016332610	PCT 760 x 9.0 Siyah / Black	760 x 9.0	227	80	100	1.200
8016332709	PCT 900 x 9.0 Beyaz / White	900 x 9.0	275	80	100	1.200
8016332710	PCT 900 x 9.0 Siyah / Black	900 x 9.0	275	80	100	1.200

• Siyah renkli kablo bağları UV (Ultraviyole) ışınlarına karşı dayanıklıdır.

• Black colored cable ties are UV (Ultraviolet) resistant.

## Yapışkan Kroşeler

Self Adhesive Tie Mounts

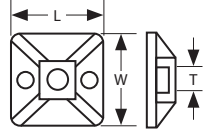

Ürün Kodu Product Code	Ürün Adı Product Name	Ölçüler Dimensions (mm)			Amb. Mik. Pack. Qty (Adet/Pcs.)
		L	W	T	
8016333009	ATM 19 x 19 Beyaz / White	19	19	3,6	100
8016333010	ATM 19 x 19 Siyah / Black	19	19	3,6	100
8016333109	ATM 28 x 28 Beyaz / White	28	28	4,8	100
8016333110	ATM 28 x 28 Siyah / Black	28	28	4,8	100

## Vidalı Kroşeler

Screw Type Tie Mounts

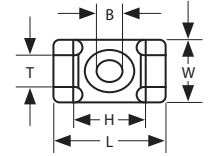

Ürün Kodu Product Code	Ürün Adı Product Name	Ölçüler Dimensions					Amb. Mik. Pack. Qty (Adet/Pcs.)
		L	W	H	T	B	
8016334009	STM 1 Beyaz / White	17,8	12,7	8,15	4,8	M3	250
8016334019	STM 2 Beyaz / White	25,4	16	10,8	9	M5	250
8016334010	STM 1 Siyah / Black	17,8	12,7	8,15	4,8	M3	250
8016334020	STM 2 Siyah / Black	25,4	16	10,8	9	M5	250

## Kablo Bağı Sıkma ve Kesme Aleti

Cable Tie Tightening and Cutting Tool



Ürün Kodu Product Code	Ürün Adı Product Name	Özellik Function	Maks. Kablo Bağı Eni Max. Cable Tie Width (mm)	Amb. Mik. Pack. Qty (Adet/Pcs.)
8016334200	CTT1	Sıkma + Kesme Tightening + Cutting	4,8	1

# tbloc

Electrical & Electronic Manufacturing

## MARKALAMA SİSTEMLERİ MARKING SYSTEMS



Klemensler için Şerit Etiket  
Kablo İşaretleme Etiketleri  
İnce Yapışkanlı Etiketler  
Kalın Yapışkanlı Etiketler  
Buton Etiketleri

Terminal Blocks Strip Labels  
Cable Marking Labels  
Thin Adhesive Labels  
Thick Adhesive Labels  
Push Button Labels



[www.tbloc.com.tr](http://www.tbloc.com.tr)



## Kablo Etiketleri

### Cable Marker

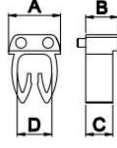

Ürün Kodu Product Code	Ürün Adı Product Name	Materyal Material	Sıcaklık Heat	Kablo Kesiti Cable Size (mm <sup>2</sup> )	Renk Color	A	B	C	D	Amb. Mik. Pack. Qty (Adet/Pcs.)	Koli Mik. Carton Qty. (Adet/Pcs.)
8021360000	UGK 1 (0)	PA	-40 °C+140 °C	0,75 - 1,50		4.4	3	2.5	2.7	400	20000
8021360011	UGK 1 (1)	PA	-40 °C+140 °C	0,75 - 1,50		4.4	3	2.5	2.7	400	20000
8021360022	UGK 1 (2)	PA	-40 °C+140 °C	0,75 - 1,50		4.4	3	2.5	2.7	400	20000
8021360033	UGK 1 (3)	PA	-40 °C+140 °C	0,75 - 1,50		4.4	3	2.5	2.7	400	20000
8021360044	UGK 1 (4)	PA	-40 °C+140 °C	0,75 - 1,50		4.4	3	2.5	2.7	400	20000
8021360055	UGK 1 (5)	PA	-40 °C+140 °C	0,75 - 1,50		4.4	3	2.5	2.7	400	20000
8021360066	UGK 1 (6)	PA	-40 °C+140 °C	0,75 - 1,50		4.4	3	2.5	2.7	400	20000
8021360077	UGK 1 (7)	PA	-40 °C+140 °C	0,75 - 1,50		4.4	3	2.5	2.7	400	20000
8021360088	UGK 1 (8)	PA	-40 °C+140 °C	0,75 - 1,50		4.4	3	2.5	2.7	400	20000
8021360099	UGK 1 (9)	PA	-40 °C+140 °C	0,75 - 1,50		4.4	3	2.5	2.7	400	20000
8021360104	UGK 1 (+)	PA	-40 °C+140 °C	0,75 - 1,50		4.4	3	2.5	2.7	400	20000
8021360114	UGK 1 (-)	PA	-40 °C+140 °C	0,75 - 1,50		4.4	3	2.5	2.7	400	20000
8021360124	UGK 1 (±)	PA	-40 °C+140 °C	0,75 - 1,50		4.4	3	2.5	2.7	400	20000
8021360125	UGK 1 (A)	PA	-40 °C+140 °C	0,75 - 1,50		4.4	3	2.5	2.7	400	20000
8021360126	UGK 1 (B)	PA	-40 °C+140 °C	0,75 - 1,50		4.4	3	2.5	2.7	400	20000
8021360127	UGK 1 (C)	PA	-40 °C+140 °C	0,75 - 1,50		4.4	3	2.5	2.7	400	20000
8021360128	UGK 1 (D)	PA	-40 °C+140 °C	0,75 - 1,50		4.4	3	2.5	2.7	400	20000
8021360129	UGK 1 (E)	PA	-40 °C+140 °C	0,75 - 1,50		4.4	3	2.5	2.7	400	20000
8021360130	UGK 1 (F)	PA	-40 °C+140 °C	0,75 - 1,50		4.4	3	2.5	2.7	400	20000
8021360131	UGK 1 (G)	PA	-40 °C+140 °C	0,75 - 1,50		4.4	3	2.5	2.7	400	20000
8021360132	UGK 1 (H)	PA	-40 °C+140 °C	0,75 - 1,50		4.4	3	2.5	2.7	400	20000
8021360133	UGK 1 (I)	PA	-40 °C+140 °C	0,75 - 1,50		4.4	3	2.5	2.7	400	20000
8021360134	UGK 1 (J)	PA	-40 °C+140 °C	0,75 - 1,50		4.4	3	2.5	2.7	400	20000
8021360135	UGK 1 (K)	PA	-40 °C+140 °C	0,75 - 1,50		4.4	3	2.5	2.7	400	20000
8021360136	UGK 1 (L)	PA	-40 °C+140 °C	0,75 - 1,50		4.4	3	2.5	2.7	400	20000
8021360137	UGK 1 (M)	PA	-40 °C+140 °C	0,75 - 1,50		4.4	3	2.5	2.7	400	20000
8021360138	UGK 1 (N)	PA	-40 °C+140 °C	0,75 - 1,50		4.4	3	2.5	2.7	400	20000
8021360139	UGK 1 (O)	PA	-40 °C+140 °C	0,75 - 1,50		4.4	3	2.5	2.7	400	20000
8021360140	UGK 1 (P)	PA	-40 °C+140 °C	0,75 - 1,50		4.4	3	2.5	2.7	400	20000
8021360141	UGK 1 (R)	PA	-40 °C+140 °C	0,75 - 1,50		4.4	3	2.5	2.7	400	20000
8021360142	UGK 1 (S)	PA	-40 °C+140 °C	0,75 - 1,50		4.4	3	2.5	2.7	400	20000
8021360143	UGK 1 (T)	PA	-40 °C+140 °C	0,75 - 1,50		4.4	3	2.5	2.7	400	20000
8021360144	UGK 1 (U)	PA	-40 °C+140 °C	0,75 - 1,50		4.4	3	2.5	2.7	400	20000
8021360145	UGK 1 (V)	PA	-40 °C+140 °C	0,75 - 1,50		4.4	3	2.5	2.7	400	20000
8021360146	UGK 1 (W)	PA	-40 °C+140 °C	0,75 - 1,50		4.4	3	2.5	2.7	400	20000
8021360147	UGK 1 (X)	PA	-40 °C+140 °C	0,75 - 1,50		4.4	3	2.5	2.7	400	20000
8021360148	UGK 1 (Y)	PA	-40 °C+140 °C	0,75 - 1,50		4.4	3	2.5	2.7	400	20000
8021360149	UGK 1 (Z)	PA	-40 °C+140 °C	0,75 - 1,50		4.4	3	2.5	2.7	400	20000

## Kablo Etiketleri

Cable Marker

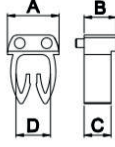

Ürün Kodu Product Code	Ürün Adı Product Name	Materyal Material	Sıcaklık Heat	Kablo Kesiti Cable Size (mm <sup>2</sup> )	Renk Color	A	B	C	D	Amb. Mik. Pack. Qty (Adet/Pcs.)	Koli Mik. Carton Qty. (Adet/Pcs.)
8021361000	UGK 2 (0)	PA	-40 °C+140 °C	1.5 - 2.5	Black	5	3	2.5	3.2	400	20000
8021361011	UGK 2 (1)	PA	-40 °C+140 °C	1.5 - 2.5	Brown	5	3	2.5	3.2	400	20000
8021361022	UGK 2 (2)	PA	-40 °C+140 °C	1.5 - 2.5	Red	5	3	2.5	3.2	400	20000
8021361033	UGK 2 (3)	PA	-40 °C+140 °C	1.5 - 2.5	Orange	5	3	2.5	3.2	400	20000
8021361044	UGK 2 (4)	PA	-40 °C+140 °C	1.5 - 2.5	Yellow	5	3	2.5	3.2	400	20000
8021361055	UGK 2 (5)	PA	-40 °C+140 °C	1.5 - 2.5	Green	5	3	2.5	3.2	400	20000
8021361066	UGK 2 (6)	PA	-40 °C+140 °C	1.5 - 2.5	Blue	5	3	2.5	3.2	400	20000
8021361077	UGK 2 (7)	PA	-40 °C+140 °C	1.5 - 2.5	Pink	5	3	2.5	3.2	400	20000
8021361088	UGK 2 (8)	PA	-40 °C+140 °C	1.5 - 2.5	Grey	5	3	2.5	3.2	400	20000
8021361099	UGK 2 (9)	PA	-40 °C+140 °C	1.5 - 2.5	White	5	3	2.5	3.2	400	20000
8021361104	UGK 2 (+)	PA	-40 °C+140 °C	1.5 - 2.5	Yellow	5	3	2.5	3.2	400	20000
8021361114	UGK 2 (-)	PA	-40 °C+140 °C	1.5 - 2.5	Yellow	5	3	2.5	3.2	400	20000
8021361124	UGK 2 ( $\frac{1}{2}$ )	PA	-40 °C+140 °C	1.5 - 2.5	Yellow	5	3	2.5	3.2	400	20000
8021361125	UGK 2 (A)	PA	-40 °C+140 °C	1.5 - 2.5	Yellow	5	3	2.5	3.2	400	20000
8021361126	UGK 2 (B)	PA	-40 °C+140 °C	1.5 - 2.5	Yellow	5	3	2.5	3.2	400	20000
8021361127	UGK 2 (C)	PA	-40 °C+140 °C	1.5 - 2.5	Yellow	5	3	2.5	3.2	400	20000
8021361128	UGK 2 (D)	PA	-40 °C+140 °C	1.5 - 2.5	Yellow	5	3	2.5	3.2	400	20000
8021361129	UGK 2 (E)	PA	-40 °C+140 °C	1.5 - 2.5	Yellow	5	3	2.5	3.2	400	20000
8021361130	UGK 2 (F)	PA	-40 °C+140 °C	1.5 - 2.5	Yellow	5	3	2.5	3.2	400	20000
8021361131	UGK 2 (G)	PA	-40 °C+140 °C	1.5 - 2.5	Yellow	5	3	2.5	3.2	400	20000
8021361132	UGK 2 (H)	PA	-40 °C+140 °C	1.5 - 2.5	Yellow	5	3	2.5	3.2	400	20000
8021361133	UGK 2 (I)	PA	-40 °C+140 °C	1.5 - 2.5	Yellow	5	3	2.5	3.2	400	20000
8021361134	UGK 2 (J)	PA	-40 °C+140 °C	1.5 - 2.5	Yellow	5	3	2.5	3.2	400	20000
8021361135	UGK 2 (K)	PA	-40 °C+140 °C	1.5 - 2.5	Yellow	5	3	2.5	3.2	400	20000
8021361136	UGK 2 (L)	PA	-40 °C+140 °C	1.5 - 2.5	Yellow	5	3	2.5	3.2	400	20000
8021361137	UGK 2 (M)	PA	-40 °C+140 °C	1.5 - 2.5	Yellow	5	3	2.5	3.2	400	20000
8021361138	UGK 2 (N)	PA	-40 °C+140 °C	1.5 - 2.5	Yellow	5	3	2.5	3.2	400	20000
8021361139	UGK 2 (O)	PA	-40 °C+140 °C	1.5 - 2.5	Yellow	5	3	2.5	3.2	400	20000
8021361140	UGK 2 (P)	PA	-40 °C+140 °C	1.5 - 2.5	Yellow	5	3	2.5	3.2	400	20000
8021361141	UGK 2 (R)	PA	-40 °C+140 °C	1.5 - 2.5	Yellow	5	3	2.5	3.2	400	20000
8021361142	UGK 2 (S)	PA	-40 °C+140 °C	1.5 - 2.5	Yellow	5	3	2.5	3.2	400	20000
8021361143	UGK 2 (T)	PA	-40 °C+140 °C	1.5 - 2.5	Yellow	5	3	2.5	3.2	400	20000
8021361144	UGK 2 (U)	PA	-40 °C+140 °C	1.5 - 2.5	Yellow	5	3	2.5	3.2	400	20000
8021361145	UGK 2 (V)	PA	-40 °C+140 °C	1.5 - 2.5	Yellow	5	3	2.5	3.2	400	20000
8021361146	UGK 2 (W)	PA	-40 °C+140 °C	1.5 - 2.5	Yellow	5	3	2.5	3.2	400	20000
8021361147	UGK 2 (X)	PA	-40 °C+140 °C	1.5 - 2.5	Yellow	5	3	2.5	3.2	400	20000
8021361148	UGK 2 (Y)	PA	-40 °C+140 °C	1.5 - 2.5	Yellow	5	3	2.5	3.2	400	20000
8021361149	UGK 2 (Z)	PA	-40 °C+140 °C	1.5 - 2.5	Yellow	5	3	2.5	3.2	400	20000

## Kablo Etiketleri

### Cable Marker

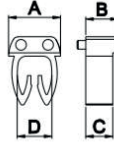

Ürün Kodu Product Code	Ürün Adı Product Name	Materyal Material	Sıcaklık Heat	Kablo Kesiti Cable Size (mm <sup>2</sup> )	Renk Color	A	B	C	D	Amb. Mik. Pack. Qty (Adet/Pcs.)	Koli Mik. Carton Qty. (Adet/Pcs.)
8021362000	UGK 3 (0)	PA	-40 °C+140 °C	4,0 - 6,0		7.4	3	2.5	4.9	400	20000
8021362011	UGK 3 (1)	PA	-40 °C+140 °C	4,0 - 6,0		7.4	3	2.5	4.9	400	20000
8021362022	UGK 3 (2)	PA	-40 °C+140 °C	4,0 - 6,0		7.4	3	2.5	4.9	400	20000
8021362033	UGK 3 (3)	PA	-40 °C+140 °C	4,0 - 6,0		7.4	3	2.5	4.9	400	20000
8021362044	UGK 3 (4)	PA	-40 °C+140 °C	4,0 - 6,0		7.4	3	2.5	4.9	400	20000
8021362055	UGK 3 (5)	PA	-40 °C+140 °C	4,0 - 6,0		7.4	3	2.5	4.9	400	20000
8021362066	UGK 3 (6)	PA	-40 °C+140 °C	4,0 - 6,0		7.4	3	2.5	4.9	400	20000
8021362077	UGK 3 (7)	PA	-40 °C+140 °C	4,0 - 6,0		7.4	3	2.5	4.9	400	20000
8021362088	UGK 3 (8)	PA	-40 °C+140 °C	4,0 - 6,0		7.4	3	2.5	4.9	400	20000
8021362099	UGK 3 (9)	PA	-40 °C+140 °C	4,0 - 6,0		7.4	3	2.5	4.9	400	20000
8021362104	UGK 3 (+)	PA	-40 °C+140 °C	4,0 - 6,0		7.4	3	2.5	4.9	400	20000
8021362114	UGK 3 (-)	PA	-40 °C+140 °C	4,0 - 6,0		7.4	3	2.5	4.9	400	20000
8021362124	UGK 3 ( $\frac{1}{2}$ )	PA	-40 °C+140 °C	4,0 - 6,0		7.4	3	2.5	4.9	400	20000
8021362125	UGK 3 (A)	PA	-40 °C+140 °C	4,0 - 6,0		7.4	3	2.5	4.9	400	20000
8021362126	UGK 3 (B)	PA	-40 °C+140 °C	4,0 - 6,0		7.4	3	2.5	4.9	400	20000
8021362127	UGK 3 (C)	PA	-40 °C+140 °C	4,0 - 6,0		7.4	3	2.5	4.9	400	20000
8021362128	UGK 3 (D)	PA	-40 °C+140 °C	4,0 - 6,0		7.4	3	2.5	4.9	400	20000
8021362129	UGK 3 (E)	PA	-40 °C+140 °C	4,0 - 6,0		7.4	3	2.5	4.9	400	20000
8021362130	UGK 3 (F)	PA	-40 °C+140 °C	4,0 - 6,0		7.4	3	2.5	4.9	400	20000
8021362131	UGK 3 (G)	PA	-40 °C+140 °C	4,0 - 6,0		7.4	3	2.5	4.9	400	20000
8021362132	UGK 3 (H)	PA	-40 °C+140 °C	4,0 - 6,0		7.4	3	2.5	4.9	400	20000
8021362133	UGK 3 (I)	PA	-40 °C+140 °C	4,0 - 6,0		7.4	3	2.5	4.9	400	20000
8021362134	UGK 3 (J)	PA	-40 °C+140 °C	4,0 - 6,0		7.4	3	2.5	4.9	400	20000
8021362135	UGK 3 (K)	PA	-40 °C+140 °C	4,0 - 6,0		7.4	3	2.5	4.9	400	20000
8021362136	UGK 3 (L)	PA	-40 °C+140 °C	4,0 - 6,0		7.4	3	2.5	4.9	400	20000
8021362137	UGK 3 (M)	PA	-40 °C+140 °C	4,0 - 6,0		7.4	3	2.5	4.9	400	20000
8021362138	UGK 3 (N)	PA	-40 °C+140 °C	4,0 - 6,0		7.4	3	2.5	4.9	400	20000
8021362139	UGK 3 (O)	PA	-40 °C+140 °C	4,0 - 6,0		7.4	3	2.5	4.9	400	20000
8021362140	UGK 3 (P)	PA	-40 °C+140 °C	4,0 - 6,0		7.4	3	2.5	4.9	400	20000
8021362141	UGK 3 (R)	PA	-40 °C+140 °C	4,0 - 6,0		7.4	3	2.5	4.9	400	20000
8021362142	UGK 3 (S)	PA	-40 °C+140 °C	4,0 - 6,0		7.4	3	2.5	4.9	400	20000
8021362143	UGK 3 (T)	PA	-40 °C+140 °C	4,0 - 6,0		7.4	3	2.5	4.9	400	20000
8021362144	UGK 3 (U)	PA	-40 °C+140 °C	4,0 - 6,0		7.4	3	2.5	4.9	400	20000
8021362145	UGK 3 (V)	PA	-40 °C+140 °C	4,0 - 6,0		7.4	3	2.5	4.9	400	20000
8021362146	UGK 3 (W)	PA	-40 °C+140 °C	4,0 - 6,0		7.4	3	2.5	4.9	400	20000
8021362147	UGK 3 (X)	PA	-40 °C+140 °C	4,0 - 6,0		7.4	3	2.5	4.9	400	20000
8021362148	UGK 3 (Y)	PA	-40 °C+140 °C	4,0 - 6,0		7.4	3	2.5	4.9	400	20000
8021362149	UGK 3 (Z)	PA	-40 °C+140 °C	4,0 - 6,0		7.4	3	2.5	4.9	400	20000

## Sıkmalı Kablo Pabuçları - Standart Seri

### Standart Range Compression Cable Lugs - Standard Line

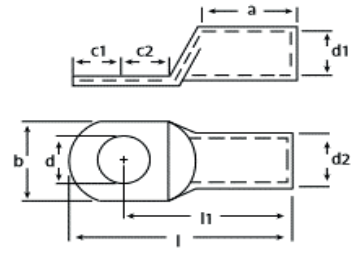

Ürün Kodu Product Code	Ürün Adı Product Name	Kesit Cross Sec. (mm <sup>2</sup> )	Ölçüler / Dimensions (mm)									Delik Çapı Hole Dia.	Amb. Mik. Pack. Qty. (Adet/Pcs.)
			d	d1	d2	l	l1	a	b	c1	c2		
<b>8029320610</b>	<b>CCL 10mm<sup>2</sup> M6</b>	<b>10</b>	<b>6,5</b>	<b>4,4</b>	<b>6</b>	<b>27,5</b>	<b>21,7</b>	<b>10</b>	<b>10,4</b>	<b>6</b>	<b>6</b>	<b>M6</b>	<b>500</b>
<b>8029320620</b>	<b>CCL 10mm<sup>2</sup> M8</b>	<b>10</b>	<b>8,5</b>	<b>4,4</b>	<b>6</b>	<b>27,5</b>	<b>21,7</b>	<b>10</b>	<b>13,7</b>	<b>6</b>	<b>6</b>	<b>M8</b>	<b>500</b>
<b>8029320630</b>	<b>CCL 16mm<sup>2</sup> M6</b>	<b>16</b>	<b>6,5</b>	<b>5,5</b>	<b>8</b>	<b>32,6</b>	<b>24,9</b>	<b>12</b>	<b>11,4</b>	<b>7</b>	<b>8</b>	<b>M6</b>	<b>300</b>
<b>8029320640</b>	<b>CCL 16mm<sup>2</sup> M8</b>	<b>16</b>	<b>8,5</b>	<b>5,5</b>	<b>8</b>	<b>32,6</b>	<b>24,9</b>	<b>12</b>	<b>13,9</b>	<b>7</b>	<b>8</b>	<b>M8</b>	<b>300</b>
8029320641	CCL 16mm <sup>2</sup> M10	16	10,5	5,5	8	32,6	24,9	12	16,1	7	8	M10	300
8029320649	CCL 25mm <sup>2</sup> M6	25	6,5	7	9	39	32,3	16	13,6	6,8	9,2	M6	200
<b>8029320650</b>	<b>CCL 25mm<sup>2</sup> M8</b>	<b>25</b>	<b>8,5</b>	<b>7</b>	<b>9</b>	<b>39</b>	<b>32,3</b>	<b>16</b>	<b>13,7</b>	<b>6,8</b>	<b>9,2</b>	<b>M8</b>	<b>200</b>
8029320651	CCL 25mm <sup>2</sup> M10	25	10,5	7	9,5	42	34,1	16	16,1	6,8	11	M10	200
8029320659	CCL 35mm <sup>2</sup> M6	35	6,5	8,5	11	44	35,6	19	15,9	8,3	9,7	M6	150
<b>8029320660</b>	<b>CCL 35mm<sup>2</sup> M8</b>	<b>35</b>	<b>8,5</b>	<b>8,5</b>	<b>11</b>	<b>44</b>	<b>35,6</b>	<b>19</b>	<b>15,9</b>	<b>8,3</b>	<b>9,7</b>	<b>M8</b>	<b>150</b>
8029320661	CCL 35mm <sup>2</sup> M10	35	10,5	8,5	11	48	37,9	19	15,8	10	12	M10	150
8029320669	CCL 50mm <sup>2</sup> M8	50	8,5	10	12	47,5	39,3	21	17,8	8,3	9,7	M8	100
<b>8029320670</b>	<b>CCL 50mm<sup>2</sup> M10</b>	<b>50</b>	<b>10,5</b>	<b>10</b>	<b>12</b>	<b>51,5</b>	<b>41,6</b>	<b>21</b>	<b>17,9</b>	<b>10</b>	<b>12</b>	<b>M10</b>	<b>100</b>
8029320671	CCL 50mm <sup>2</sup> M12	50	13	10	13	51,5	41,6	21	19,2	10	12	M12	100
8029320672	CCL 50mm <sup>2</sup> M14	50	15	10	13	56,5	44,6	21	20,7	12	15	M14	100
8029320679	CCL 70mm <sup>2</sup> M8	70	8,5	11,5	14,5	54,6	44,5	23	21,2	10	12	M8	75
<b>8029320680</b>	<b>CCL 70mm<sup>2</sup> M10</b>	<b>70</b>	<b>10,5</b>	<b>11,5</b>	<b>14,5</b>	<b>54,6</b>	<b>44,5</b>	<b>23</b>	<b>21,2</b>	<b>10</b>	<b>12</b>	<b>M10</b>	<b>75</b>
8029320681	CCL 70mm <sup>2</sup> M12	70	13	11,5	14,5	54,6	44,5	23	21,3	10	12	M12	75
8029320682	CCL 70mm <sup>2</sup> M14	70	15	11,5	14,5	62,6	47,5	23	21,5	15	15	M14	75
8029320689	CCL 95mm <sup>2</sup> M8	95	8,5	13,5	17	58,8	48,9	26	24,7	10	12	M8	50
<b>8029320690</b>	<b>CCL 95mm<sup>2</sup> M10</b>	<b>95</b>	<b>10,5</b>	<b>13,5</b>	<b>17</b>	<b>58,8</b>	<b>48,9</b>	<b>26</b>	<b>24,7</b>	<b>10</b>	<b>12</b>	<b>M10</b>	<b>50</b>
<b>8029320700</b>	<b>CCL 95mm<sup>2</sup> M12</b>	<b>95</b>	<b>13</b>	<b>13,5</b>	<b>17</b>	<b>58,8</b>	<b>48,9</b>	<b>26</b>	<b>24,6</b>	<b>10</b>	<b>12</b>	<b>M12</b>	<b>50</b>
8029320709	CCL 120mm <sup>2</sup> M10	120	10,5	15,5	19	69	55,9	29	28,1	13	14,5	M10	40
<b>8029320710</b>	<b>CCL 120mm<sup>2</sup> M12</b>	<b>120</b>	<b>13</b>	<b>15,5</b>	<b>19</b>	<b>69</b>	<b>55,9</b>	<b>29</b>	<b>28,2</b>	<b>13</b>	<b>14,5</b>	<b>M12</b>	<b>40</b>
8029320711	CCL 120mm <sup>2</sup> M16	120	17	15,5	19	69	55,9	29	28,2	13	14,5	M16	40
8029320719	CCL 150mm <sup>2</sup> M10	150	10,5	16,5	16,5	76,5	59,9	30	30,2	16,5	16,5	M10	30
<b>8029320720</b>	<b>CCL 150mm<sup>2</sup> M12</b>	<b>150</b>	<b>13</b>	<b>16,5</b>	<b>21</b>	<b>76,5</b>	<b>59,9</b>	<b>30</b>	<b>30,1</b>	<b>16,5</b>	<b>16,5</b>	<b>M12</b>	<b>30</b>
8029320721	CCL 150mm <sup>2</sup> M16	150	17	16,5	21	76,5	59,9	30	30,1	16,5	16,5	M16	30
8029320729	CCL 185mm <sup>2</sup> M12	185	13	18,5	23	82,5	65,6	33	34,2	17	18	M12	25
<b>8029320730</b>	<b>CCL 185mm<sup>2</sup> M16</b>	<b>185</b>	<b>17</b>	<b>18,5</b>	<b>23</b>	<b>82,5</b>	<b>65,6</b>	<b>33</b>	<b>34,1</b>	<b>17</b>	<b>18</b>	<b>M16</b>	<b>25</b>
8029320739	CCL 240mm <sup>2</sup> M12	240	13	21	26	89	72,1	38	38,2	17	18	M12	20
<b>8029320740</b>	<b>CCL 240mm<sup>2</sup> M16</b>	<b>240</b>	<b>17</b>	<b>21</b>	<b>26</b>	<b>89</b>	<b>72,1</b>	<b>38</b>	<b>38,2</b>	<b>17</b>	<b>18</b>	<b>M16</b>	<b>20</b>



**Malzeme** : EN 13600 Standardında elektrolitik bakır  
**Kaplama** : Minimum 3 mikron (µm) Kalay Kaplama

Material : EN 13600 Standarts Electrolytically Tin (E-Cu) Plated Copper  
 Plating : Minimum 3 microns (µm) Tin Plated

**\*\* Koyu renk ile işaretlenmiş kablo pabuçları standart ürünlerimiz olup, diğer kalemler için lütfen stok durumunu sorunuz.**

**\*\* Bold fonted items are our standart sizes, pls ask stock availability for other items.**

## Standart Kablo Pabuçları - Eko Seri

### Compression Cable Lugs - Eco Line

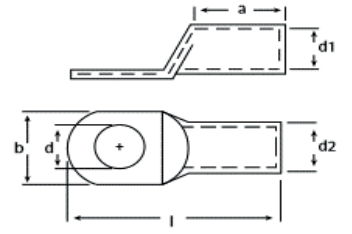

Ürün Kodu Product Code	Ürün Adı Product Name	Kesit Cross Sec. (mm <sup>2</sup> )	Ölçüler / Dimensions (mm)						Delik Çapı Hole Dia.	Amb. Mik. Pack. Qty. (Adet/Pcs.)
			d	d1	d2	l	a	b		
8029320500	<b>CCL-E 16 M6</b>	16	6,5	5,5	7	32,5	11	10,5	M6	500
8029320510	<b>CCL-E 16 M8</b>	16	8,5	5,5	7	32,5	11	13	M8	500
8029320520	<b>CCL-E 25 M8</b>	25	8,5	7	9	38,5	16	13	M8	300
8029320530	<b>CCL-E 35 M8</b>	35	8,5	8,5	10,5	43,5	19	15,5	M8	200
8029320540	<b>CCL-E 50 M10</b>	50	10,5	10	12	51,5	21	17,6	M10	125
8029320550	<b>CCL-E 70 M10</b>	70	10,5	11,5	14	55,5	23	20,7	M10	100
8029320560	<b>CCL-E 95 M12</b>	95	13	13,5	16	58,5	26	23,5	M12	75
8029320570	<b>CCL-E 120 M12</b>	120	13	15,5	18	71	29	26,7	M12	50
8029320580	<b>CCL-E 150 M12</b>	150	13	16,5	20	76	30	29,2	M12	30
8029320590	<b>CCL-E 185 M16</b>	185	17	18,5	22	82	33	32,3	M16	25
8029320600	<b>CCL-E 240 M16</b>	240	17	21,5	25,5	91	38	37,6	M16	20

**Malzeme** : EN 13600 Standardında elektrolitik bakır  
**Kaplama** : Minimum 3 mikron (µm) Kalay Kaplama

**Material** : EN 13600 Standarts Electrolytically Tin (E-Cu) Plated Copper  
**Plating** : Minimum 3 microns (µm) Tin Plated



## Standart Seri Ek Muflar

### Standard Range Compression Butt Terminals



Ürün Kodu Product Code	Ürün Adı Product Name	Kesit Cross Sec. (mm <sup>2</sup> )	Ölçüler / Dimensions (mm)			Amb. Mik. Pack. Qty. (Adet/Pcs.)
			d1	d2	l	
8029320845	<b>CBT 10</b>	10	4,4	6	27	400
8029320850	<b>CBT 16</b>	16	5,5	8	32	250
8029320860	<b>CBT 25</b>	25	7	9	40,5	200
8029320870	<b>CBT 35</b>	35	8,2	11	45,5	150
8029320880	<b>CBT 50</b>	50	9,5	13	53,5	80
8029320890	<b>CBT 70</b>	70	11,2	14,5	57,5	60
8029320900	<b>CBT 95</b>	95	13,4	17	61,5	40
8029320910	<b>CBT 120</b>	120	15	19,5	74	30
8029320920	<b>CBT 150</b>	150	16,5	21	79	25
8029320930	<b>CBT 185</b>	185	19	24	85	18
8029320940	<b>CBT 240</b>	240	21	26	95	13

**Malzeme** : EN 13600 Standardında elektrolitik bakır

**Kaplama** : Minimum 3 mikron (µm) Kalay Kaplama

Material : EN 13600 Standarts Electrolytically Tin (E-Cu) Plated Copper

Plating : Minimum 3 microns (µm) Tin Plated

## Eko Seri Ek Muflar

### Economical Range Compression Butt Terminals

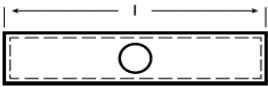

Ürün Kodu Product Code	Ürün Adı Product Name	Kesit Cross Sec. (mm <sup>2</sup> )	Uzunluk Lenght (l) mm	Amb. Mik. Pack. Qty. (Adet/Pcs.)
8029320750	<b>CBT-E 16</b>	16	32	300
8029320760	<b>CBT-E 25</b>	25	41	200
8029320770	<b>CBT-E 35</b>	35	46	150
8029320780	<b>CBT-E 50</b>	50	54	125
8029320790	<b>CBT-E 70</b>	70	58	100
8029320800	<b>CBT-E 95</b>	95	62	60
8029320810	<b>CBT-E 120</b>	120	74	40
8029320820	<b>CBT-E 150</b>	150	80	30
8029320830	<b>CBT-E 185</b>	185	86	22
8029320840	<b>CBT-E 240</b>	240	95	15

**Malzeme** : EN 13600 Standardında elektrolitik bakır

**Kaplama** : Minimum 3 mikron (µm) Kalay Kaplama

Material : EN 13600 Standarts Electrolytically Tin (E-Cu) Plated Copper

Plating : Minimum 3 microns (µm) Tin Plated

## Yuvarlak Pabuçlar

Insulated Ring Terminals

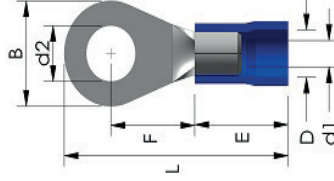

Ürün Kodu Product Code	Ürün Adı Product Name	Kesit Cross Sect. (mm <sup>2</sup> )	Ölçüler Dimensions (mm)							Renk Color	Amb. Mik. Pack. Qty (Adet/Pcs.)
			d2	B	F	L	E	D	d1		
8018335500	<b>IRT 301</b>	0,5 - 1,5	3,2	5,5	4	16,7	10	4,1	1,7	<b>Kırmızı</b> / Red	200
8018335510	<b>IRT 351</b>	0,5 - 1,5	3,7	5,5	4	16,7	10	4,1	1,7	<b>Kırmızı</b> / Red	200
8018335520	<b>IRT 401</b>	0,5 - 1,5	4,3	6,6	6,3	19,6	10	4,1	1,7	<b>Kırmızı</b> / Red	200
8018335530	<b>IRT 501</b>	0,5 - 1,5	5,3	8	7	21	10	4,1	1,7	<b>Kırmızı</b> / Red	200
8018335540	<b>IRT 601</b>	0,5 - 1,5	6,5	11,6	11,1	26,8	10	4,1	1,7	<b>Kırmızı</b> / Red	200
8018335550	<b>IRT 801</b>	0,5 - 1,5	8,4	11,6	11,1	26,8	10	4,1	1,7	<b>Kırmızı</b> / Red	200
8018335560	<b>IRT 302</b>	1,5 - 2,5	3,2	6,4	4,3	17,5	10	4,5	2,3	<b>Mavi</b> / Blue	200
8018335570	<b>IRT 402</b>	1,5 - 2,5	4,3	6,6	6,3	19,5	10	4,5	2,3	<b>Mavi</b> / Blue	200
8018335580	<b>IRT 502</b>	1,5 - 2,5	5,3	8,5	7,8	22	10	4,5	2,3	<b>Mavi</b> / Blue	200
8018335590	<b>IRT 602</b>	1,5 - 2,5	6,5	12	11	27	10	4,5	2,3	<b>Mavi</b> / Blue	200
8018335600	<b>IRT 802</b>	1,5 - 2,5	8,4	12	11	27	10	4,5	2,3	<b>Mavi</b> / Blue	200
8018335610	<b>IRT 1002</b>	1,5 - 2,5	10,5	13,6	13,9	30,7	10	4,5	2,3	<b>Mavi</b> / Blue	100
8018335620	<b>IRT 406</b>	4,0 - 6,0	4,3	7,2	5,9	22	12,5	6,5	3,4	<b>Sarı</b> / Yellow	75
8018335630	<b>IRT 506</b>	4,0 - 6,0	5,3	9,5	8,3	25,5	12,5	6,5	3,4	<b>Sarı</b> / Yellow	75
8018335640	<b>IRT 606</b>	4,0 - 6,0	6,5	12	10,5	29	12,5	6,5	3,4	<b>Sarı</b> / Yellow	75
8018335650	<b>IRT 806</b>	4,0 - 6,0	8,4	15	13,7	33,7	12,5	6,5	3,4	<b>Sarı</b> / Yellow	75
8018335660	<b>IRT 1006</b>	4,0 - 6,0	10,5	15	13,7	33,7	12,5	6,5	3,4	<b>Sarı</b> / Yellow	75
8018335670	<b>IRT 1206</b>	4,0 - 6,0	13	19,2	16	38,1	12,5	6,5	3,4	<b>Sarı</b> / Yellow	75
8018335680	<b>IRT 510</b>	8,0 - 10,0	5,3	12	9,7	32,5	17	8	4,5	<b>Kırmızı</b> / Red	50
8018335690	<b>IRT 610</b>	8,0 - 10,0	6,7	12	9,7	32,5	17	8	4,5	<b>Kırmızı</b> / Red	50

\* Malzeme: Bakır, Nikel Kaplı

\* Material: Copper, Nickel Plated - PVC

## Çatal Pabuçlar

Insulated Fork Terminals

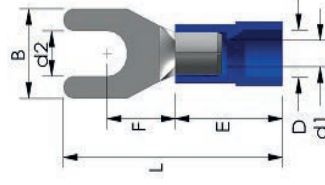

EAC

Ürün Kodu Product Code	Ürün Adı Product Name	Kesit Cross Sect. (mm <sup>2</sup> )	Ölçüler Dimensions (mm)							Renk Color	Amb. Mik. Pack. Qty (Adet/Pcs.)
			d2	B	F	L	E	D	d1		
8018335700	<b>IFT 301</b>	0,5 - 1,5	3,2	5,8	6,3	21	10	4,1	1,7	<b>Kırmızı / Red</b>	200
8018335720	<b>IFT 401</b>	0,5 - 1,5	4,3	6,4	6,3	20,6	10	4,1	1,7	<b>Kırmızı / Red</b>	200
8018335730	<b>IFT 501</b>	0,5 - 1,5	5,3	8	7	21	10	4,1	1,7	<b>Kırmızı / Red</b>	200
8018335740	<b>IFT 601</b>	0,5 - 1,5	6,5	12	11	27,2	10	4,1	1,7	<b>Kırmızı / Red</b>	200
8018335750	<b>IFT 302</b>	1,5 - 2,5	3,2	5,8	6,3	21	10	4,2	2,3	<b>Mavi / Blue</b>	200
8018335760	<b>IFT 402</b>	1,5 - 2,5	4,3	6,4	6,3	21	10	4,2	2,3	<b>Mavi / Blue</b>	200
8018335770	<b>IFT 502</b>	1,5 - 2,5	5,3	9,5	7,2	22	10	4,2	2,3	<b>Mavi / Blue</b>	200
8018335780	<b>IFT 602</b>	1,5 - 2,5	6,5	12	11	27,2	10	4,2	2,3	<b>Mavi / Blue</b>	200
8018335790	<b>IFT 406</b>	4,0 - 6,0	4,3	8,5	7,5	25,2	12,5	6,5	3,4	<b>Sarı / Yellow</b>	75
8018335800	<b>IFT 506</b>	4,0 - 6,0	5,3	9,5	7,5	25,2	12,5	6,5	3,4	<b>Sarı / Yellow</b>	75
8018335810	<b>IFT 606</b>	4,0 - 6,0	6,5	9,5	7,5	25,2	12,5	6,5	3,4	<b>Sarı / Yellow</b>	75
8018335820	<b>IFT 806</b>	4,0 - 6,0	8,4	13,5	10,5	30	12,5	6,5	3,4	<b>Sarı / Yellow</b>	75

\* Malzeme: Bakır, Nikel Kaplı

\* Material: Copper, Nickel Plated - PVC

## Faston Dişi Pabuçlar

Fast-on Female Terminals

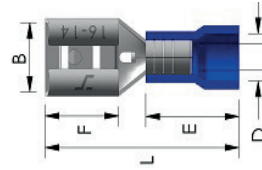

EAC

Ürün Kodu Product Code	Ürün Adı Product Name	Kesit Cross Sect. (mm <sup>2</sup> )	Ölçüler Dimensions (mm)					Renk Color	Amb. Mik. Pack. Qty (Adet/Pcs.)
			B	F	L	E	D		
8018336030	<b>FFT 1288</b>	0,5 - 1,5	3,20	6,5	19,0	10,5	3,8	<b>Kırmızı / Red</b>	200
8018336100	<b>FFT 1488</b>	0,5 - 1,5	5,00	6,4	19,4	10,5	3,8	<b>Kırmızı / Red</b>	200
8018336110	<b>FFT 1638</b>	0,5 - 1,5	6,60	7,5	20,8	10,5	3,8	<b>Kırmızı / Red</b>	200
8018336115	<b>FFT 2288</b>	1,5 - 2,5	5,00	6,4	19,4	10,5	4,7	<b>Mavi / Blue</b>	150
8018336120	<b>FFT 2488</b>	1,5 - 2,5	6,60	7,5	20,8	10,5	4,7	<b>Mavi / Blue</b>	150
8018336130	<b>FFT 2638</b>	1,5 - 2,5	6,60	7,5	23,3	13,0	6,2	<b>Mavi / Blue</b>	150
8018336140	<b>FFT 5638</b>	4,0 - 6,0	6,6	7,2	23,3	13	5,6	<b>Sarı / Yellow</b>	100

\* Malzeme: Pirinç, Kalay Kaplı

\* Material: Brass, Tin Plated - PVC



## İzoleli Faston Dişi Pabuçlar

Insulated Fast-on Female Terminals

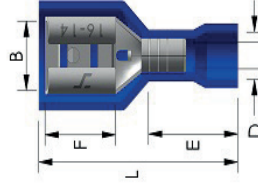

Ürün Kodu Product Code	Ürün Adı Product Name	Kesit Cross Sect. (mm <sup>2</sup> )	Ölçüler Dimensions (mm)					Renk Color	Amb. Mik. Pack. Qty (Adet/Pcs.)
			B	F	L	E	D		
8018336300	<b>IFFT 1288</b>	0,5 - 1,5	3,2	6,5	19,00	10,50	3,8	<b>Kırmızı / Red</b>	200
8018336310	<b>IFFT 1488</b>	0,5 - 1,5	5	6,4	20,50	10,50	3,8	<b>Kırmızı / Red</b>	200
8018336320	<b>IFFT 1638</b>	0,5 - 1,5	6,6	7,5	21,80	10,50	3,8	<b>Kırmızı / Red</b>	100
8018336325	<b>IFFT 2288</b>	1,5 - 2,5	3,2	6,4	20,0	10	4,2	<b>Mavi / Blue</b>	100
8018336330	<b>IFFT 2488</b>	1,5 - 2,5	5	6,4	19,2	10	4,2	<b>Mavi / Blue</b>	100
8018336340	<b>IFFT 2638</b>	1,5 - 2,5	6,6	7,5	24,20	12,50	6,2	<b>Mavi / Blue</b>	100
8018336350	<b>IFFT 5638</b>	4,0 - 6,0	6,6	7,2	23,8	13	5,6	<b>Sarı / Yellow</b>	75

\* Malzeme: Pirinç, Kalay Kaplı  
\* Material: Brass, Tin Plated - PVC

## Faston Erkek Pabuçlar

Fast-on Male Terminals

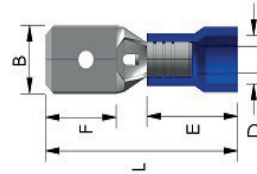

Ürün Kodu Product Code	Ürün Adı Product Name	Kesit Cross Sect. (mm <sup>2</sup> )	Ölçüler Dimensions (mm)					Renk Color	Amb. Mik. Pack. Qty (Adet/Pcs.)
			B	F	L	E	D		
8018336150	<b>FMT 1288</b>	0,5 - 1,5	2,80	6,5	19,2	10,5	3,8	<b>Kırmızı / Red</b>	200
8018336160	<b>FMT 1488</b>	0,5 - 1,5	4,80	6,7	19,8	10,5	3,8	<b>Kırmızı / Red</b>	200
8018336170	<b>FMT 1638</b>	0,5 - 1,5	6,35	7,7	21,8	10,5	3,8	<b>Kırmızı / Red</b>	200
8018336175	<b>FMT 2288</b>	1,5 - 2,5	4,80	6,7	19,8	10,5	4,7	<b>Mavi / Blue</b>	200
8018336180	<b>FMT 2488</b>	1,5 - 2,5	4,80	7,7	21,8	10,5	4,7	<b>Mavi / Blue</b>	200
8018336190	<b>FMT 2638</b>	1,5 - 2,5	6,35	7,7	24,8	13,0	6,2	<b>Mavi / Blue</b>	200
8018336200	<b>FMT 5638</b>	4,0 - 6,0	6,3	7,7	24	13	5,6	<b>Sarı / Yellow</b>	100

\* Malzeme: Pirinç, Kalay Kaplı  
\* Material: Brass, Tin Plated - PVC

## Geri Dönürlü Pabuçlar

Piggy Back Terminals

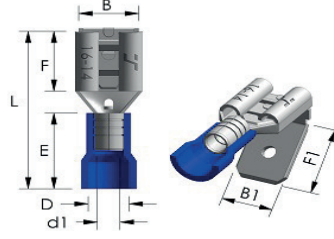

Ürün Kodu Product Code	Ürün Adı Product Name	Kesit Cross Sect. (mm <sup>2</sup> )	Ölçüler Dimensions (mm)								Renk Color	Amb. Mik. Pack. Qty (Adet/Pcs.)
			B	B1	F	F1	L	E	D	d1		
8018336460	<b>PBT 1638</b>	0,5 - 1,5	6,6	6,3	8	8,2	22	10	3,5	1,7	<b>Kırmızı / Red</b>	100
8018336470	<b>PBT 2638</b>	1,5 - 2,5	6,6	6,3	8	8,2	22	10	4,2	2,3	<b>Mavi / Blue</b>	100
8018336480	<b>PBT 5638</b>	4,0 - 6,0	6,6	6,3	8	8,2	25	13	5,6	3,4	<b>Sarı / Yellow</b>	100

\* Malzeme: Bakır, Kalay Kaplı  
\* Material: Copper, Tin Plated - PVC

## İğne Tip Pabuçlar

Insulated Pin Terminals

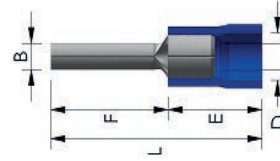

Ürün Kodu Product Code	Ürün Adı Product Name	Kesit Cross Sect. (mm <sup>2</sup> )	Ölçüler Dimensions (mm)					Renk Color	Amb. Mik. Pack. Qty (Adet/Pcs.)
			B	F	L	E	D		
8018335900	<b>IPT 1/1,5</b>	0,5 - 1,5	1,9	10	20	10	4,0	<b>Kırmızı / Red</b>	200
8018335910	<b>IPT 1/2,5</b>	1,5 - 2,5	1,9	12	22	10	4,5	<b>Mavi / Blue</b>	200
8018335920	<b>IPT 1/6</b>	4,0 - 6,0	2,8	14	27	13	6,4	<b>Sarı / Yellow</b>	100

\* Malzeme: Bakır, Kalay Kaplı  
\* Material: Copper, Tin Plated - PVC

## Dişi Pabuçlar

Bullet Female Terminals

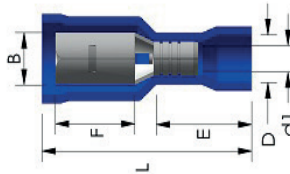

Ürün Kodu Product Code	Ürün Adı Product Name	Kesit Cross Sect. (mm <sup>2</sup> )	Ölçüler Dimensions (mm)						Renk Color	Amb. Mik. Pack. Qty (Adet/Pcs.)
			B	F	L	E	D	d1		
8018336600	<b>BFT 1040</b>	0,5 - 1,5	3,9	7,3	23,5	10	3,5	1,7	<b>Kırmızı / Red</b>	100
8018336610	<b>BFT 2050</b>	1,5 - 2,5	4,9	8,5	25	10	4,2	2,3	<b>Mavi / Blue</b>	100
8018336620	<b>BFT 5050</b>	4,0 - 6,0	4,9	8,5	28	13	5,6	3,4	<b>Sarı / Yellow</b>	50

\* Malzeme: Bakır, Kalay Kaplı  
\* Material: Copper, Tin Plated - PVC

## Erkek Pabuçlar

Bullet Male Terminals

EAC

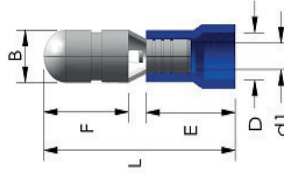

Ürün Kodu Product Code	Ürün Adı Product Name	Kesit Cross Sect. (mm <sup>2</sup> )	Ölçüler Dimensions (mm)						Renk Color	Amb. Mik. Pack. Qty (Adet/Pcs.)
			B	F	L	E	D	d1		
8018336700	<b>BMT 1040</b>	0,5 - 1,5	4	8,5	21	10	3,5	1,7	<b>Kırmızı</b> / Red	100
8018336710	<b>BMT 2050</b>	1,5 - 2,5	5	9	21,5	10	4,2	2,3	<b>Mavi</b> / Blue	100
8018336720	<b>BMT 5050</b>	4,0 - 6,0	5	9	24,5	13	5,6	3,4	<b>Sarı</b> / Yellow	100

\* Malzeme: Bakır, Kalay Kaplı  
\* Material: Copper, Tin Plated - PVC

## Ek Muflar

Insulated Butt Terminals

EAC

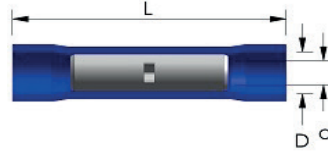

Ürün Kodu Product Code	Ürün Adı Product Name	Kesit Cross Sect. (mm <sup>2</sup> )	Ölçüler Dimensions (mm)			Renk Color	Amb. Mik. Pack. Qty (Adet/Pcs.)
			L	D	d		
8018336500	<b>IBT 251</b>	0,5 - 1,5	24,5	4,3	1,7	<b>Kırmızı</b> / Red	100
8018336510	<b>IBT 252</b>	1,5 - 2,5	24,5	4,8	2,3	<b>Mavi</b> / Blue	100
8018336520	<b>IBT 256</b>	4,0 - 6,0	27	6,2	3,4	<b>Sarı</b> / Yellow	100

\* Malzeme: Bakır, Kalay Kaplı  
\* Material: Copper, Tin Plated - PVC

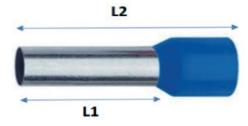

## İzoleli Kablo Yüksükleri

Insulated End Sleeves



Ürün Kodu Product Code	Ürün Adı Product Name	Ölçüler Dimensions (mm)		Kesit Cross Sect. (mm <sup>2</sup> )	AWG	Norm	Amb. Mik. Pack. Qty (Adet/Pcs.)
		L1	L2				
8017335000	<b>IES 0,50/8 Turuncu</b> / Orange	8	12	0,5	20	Alman / German	1.000
8017335010	<b>IES 0,75/8 Beyaz</b> / White	8	14	0,75	18	Alman / German	1.000
8017335020	<b>IES 1,0/8 Sarı</b> / Yellow	8	14	1	17	Alman / German	1.000
8017335030	<b>IES 1,5/8 Kırmızı</b> / Red	8	14	1,5	16	Alman / German	1.000
8017335040	<b>IES 2,5/8 Mavi</b> / Blue	8	14	2,5	14	Alman / German	500
8017335050	<b>IES 4,0/10 Gri</b> / Gray	10	17	4	12	Alman / German	500
8017335060	<b>IES 6,0/12 Siyah</b> / Black	12	20	6	10	Alman / German	250
8017335070	<b>IES 10,0/12 Fildişi</b> / Ivory	12	22	10	8	Alman / German	100
8017335080	<b>IES 16,0/12 Yeşil</b> / Green	12	24	16	6	Alman / German	100
8017335090	<b>IES 25,0/16 Kahve</b> / Brown	16	28	25	4	Alman / German	50
8017335100	<b>IES 35,0/16 Bej</b> / Beige	16	30	35	2	Alman / German	50
8017335110	<b>IES 50,0/20 Zeytin Yeşili</b> / Olive Green	20	36	50	1	Alman / German	25

Ürün Kodu Product Code	Ürün Adı Product Name	Ölçüler Dimensions (mm)		Kesit Cross Sect. (mm <sup>2</sup> )	AWG	Norm	Amb. Mik. Pack. Qty (Adet/Pcs.)
		L1	L2				
8017335005	<b>IES 0,50/8 Beyaz</b> / White	8	12	0,5	20	Fransız / French	1.000
8017335015	<b>IES 0,75/8 Mavi</b> / Blue	8	14	0,75	18	Fransız / French	1.000
8017335025	<b>IES 1,0/8 Kırmızı</b> / Red	8	14	1	17	Fransız / French	1.000
8017335035	<b>IES 1,5/8 Siyah</b> / Black	8	14	1,5	16	Fransız / French	1.000
8017335045	<b>IES 2,5/8 Gri</b> / Gray	8	14	2,5	14	Fransız / French	500
8017335055	<b>IES 4,0/10 Turuncu</b> / Orange	10	17	4	12	Fransız / French	500
8017335065	<b>IES 6,0/12 Yeşil</b> / Green	12	20	6	10	Fransız / French	250
8017335075	<b>IES 10,0/12 Kahve</b> / Brown	12	22	10	8	Fransız / French	100
8017335085	<b>IES 16,0/12 Bej</b> / Beige	12	24	16	6	Fransız / French	100
8017335095	<b>IES 25,0/16 Siyah</b> / Black	16	28	25	4	Fransız / French	50
8017335105	<b>IES 35,0/16 Kırmızı</b> / Red	16	30	35	2	Fransız / French	50
8017335115	<b>IES 50,0/20 Mavi</b> / Blue	20	36	50	1	Fransız / French	25
8017335125	<b>IES 70,0/20 Sarı</b> / Yellow	20	37	70	1	Fransız / French	25

\* Malzeme: Bakır, Kalay Kaplı

\* Material: Copper, Tin Plated - PVC



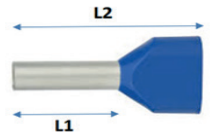

## Çift Girişli Kablo Yüksükleri

Twin Cord End Sleeves



Ürün Kodu Product Code	Ürün Adı Product Name	Ölçüler Dimensions (mm)		Kesit Cross Sect. (mm <sup>2</sup> )	Norm	Amb. Mik. Pack. Qty (Adet/Pcs.)
		L1	L2			
8017335400	IES 2x0,50/8 Turuncu / Orange	8	14	2 x 0,5	Alman / German	1.000
8017335410	IES 2x0,75/8 Beyaz / White	8	14	2 x 0,75	Alman / German	500
8017335420	IES 2x1,0/8 Sarı / Yellow	8	14	2 x 1,0	Alman / German	500
8017335430	IES 2x1,5/8 Kırmızı / Red	8	14	2 x 1,5	Alman / German	500
8017335440	IES 2x2,5/10 Mavi / Blue	10	14	2 x 2,5	Alman / German	250
8017335450	IES 2x4,0/12 Gri / Gray	12	17	2 x 4,0	Alman / German	200
8017335460	IES 2x6,0/14 Siyah / Black	14	20	2 x 6,0	Alman / German	100
8017335470	IES 2x10,0/14 Fildişi / Ivory	14	27	2 x 10	Alman / German	50
8017335480	IES 2x16,0/14 Yeşil / Green	14	31	2 x 16	Alman / German	50

Ürün Kodu Product Code	Ürün Adı Product Name	Ölçüler Dimensions (mm)		Kesit Cross Sect. (mm <sup>2</sup> )	Norm	Amb. Mik. Pack. Qty (Adet/Pcs.)
		L1	L2			
8017335405	IES 2x0,50/8 Beyaz / White	8	14	2 x 0,5	Fransız / French	1.000
8017335415	IES 2x0,75/8 Mavi / Blue	8	14	2 x 0,75	Fransız / French	500
8017335425	IES 2x1,0/8 Kırmızı / Red	8	14	2 x 1,0	Fransız / French	500
8017335435	IES 2x1,5/8 Siyah / Black	8	14	2 x 1,5	Fransız / French	500
8017335445	IES 2x2,5/10 Gri / Gray	10	14	2 x 2,5	Fransız / French	250
8017335455	IES 2x4,0/12 Turuncu / Orange	12	17	2 x 4,0	Fransız / French	200
8017335465	IES 2x6,0/14 Yeşil / Green	14	20	2 x 6,0	Fransız / French	100
8017335475	IES 2x10,0/14 Kahve / Brown	14	27	2 x 10	Fransız / French	50
8017335485	IES 2x16,0/14 Bej / Beige	14	31	2 x 16	Fransız / French	50

\* Malzeme: Bakır, Kalay Kaplı  
\* Material: Copper, Tin Plated - PVC



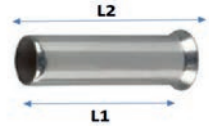

## İzolesiz Kablo Yüksükleri

Non-insulated End Sleeves



Ürün Kodu Product Code	Ürün Adı Product Name	Ölçüler Dimensions (mm)		Kesit Cross Sect. (mm <sup>2</sup> )	AWG	Amb. Mik. Pack. Qty (Adet/Pcs.)
		L1	L2			
8017335220	<b>ES 0,50/10</b>	8	10	0,50	20	2.000
8017335230	<b>ES 0,75/10</b>	8	10	0,75	18	2.000
8017335240	<b>ES 1,0/10</b>	8	10	1,00	17	2.000
8017335250	<b>ES 1,5/10</b>	8	10	1,50	15	2.000
8017335260	<b>ES 2,5/12</b>	8	12	2,50	13	2.000
8017335270	<b>ES 4,0/12</b>	10	12	4,00	11	1.000
8017335280	<b>ES 6,0/12</b>	10	12	6,00	9	500
8017335290	<b>ES 10,0/15</b>	12	15	10,00	7	200
8017335300	<b>ES 16,0/15</b>	12	15	16,00	5	200
8017335310	<b>ES 25,0/16</b>	16	16	25,00	4	100
8017335320	<b>ES 35,0/16</b>	16	16	35,00	2	100
8017335330	<b>ES 50,0/20</b>	20	20	50,00	1	50

\* Malzeme: Bakır, Kalay Kaplı

\* Material: Copper, Tin Plated - PVC



## Ledli Sinyal Lambaları - Ø22 mm

LED Indicators - Ø22 mm

Ürün Kodu Product Code	Ürün Adı Product Name	Nominal Gerilim Nominal Voltage (V)	Renk Color	Amb. Mik. Pack. Qty (Adet/Pcs.)	
8026078912	SIL22-220 Kırmızı Sinyal Lambası Ledli	SIL22-220 Red Signal Lamp with LED	220V AC	●	25
8026078915	SIL22-220 Yeşil Sinyal Lambası Ledli	SIL22-220 Green Signal Lamp with LED	220V AC	●	25
8026078914	SIL22-220 Sarı Sinyal Lambası Ledli	SIL22-220 Yellow Signal Lamp with LED	220V AC	●	25
8026078916	SIL22-220 Mavi Sinyal Lambası Ledli	SIL22-220 Blue Signal Lamp with LED	220V AC	●	25
8026078919	SIL22-220 Beyaz Sinyal Lambası Ledli	SIL22-220 White Signal Lamp with LED	220V AC	○	25
8026078922	SIL22-220DC Kırmızı Sinyal Lambası Ledli	SIL22-220DC Red Signal Lamp with LED	220V DC	●	25
8026078925	SIL22-220DC Yeşil Sinyal Lambası Ledli	SIL22-220DC Green Signal Lamp with LED	220V DC	●	25
8026078924	SIL22-220DC Sarı Sinyal Lambası Ledli	SIL22-220DC Yellow Signal Lamp with LED	220V DC	●	25
8026078926	SIL22-220DC Mavi Sinyal Lambası Ledli	SIL22-220DC Blue Signal Lamp with LED	220V DC	●	25
8026078929	SIL22-220DC Beyaz Sinyal Lambası Ledli	SIL22-220DC White Signal Lamp with LED	220V DC	○	25
8026078932	SIL22-110 Kırmızı Sinyal Lambası Ledli	SIL22-110 Red Signal Lamp with LED	110V AC/DC	●	25
8026078935	SIL22-110 Yeşil Sinyal Lambası Ledli	SIL22-110 Green Signal Lamp with LED	110V AC/DC	●	25
8026078934	SIL22-110 Sarı Sinyal Lambası Ledli	SIL22-110 Yellow Signal Lamp with LED	110V AC/DC	●	25
8026078936	SIL22-110 Mavi Sinyal Lambası Ledli	SIL22-110 Blue Signal Lamp with LED	110V AC/DC	●	25
8026078939	SIL22-110 Beyaz Sinyal Lambası Ledli	SIL22-110 White Signal Lamp with LED	110V AC/DC	○	25
8026078942	SIL22-24 Kırmızı Sinyal Lambası Ledli	SIL22-24 Red Signal Lamp with LED	24V AC/DC	●	25
8026078945	SIL22-24 Yeşil Sinyal Lambası Ledli	SIL22-24 Green Signal Lamp with LED	24V AC/DC	●	25
8026078944	SIL22-24 Sarı Sinyal Lambası Ledli	SIL22-24 Yellow Signal Lamp with LED	24V AC/DC	●	25
8026078946	SIL22-24 Mavi Sinyal Lambası Ledli	SIL22-24 Blue Signal Lamp with LED	24V AC/DC	●	25
8026078949	SIL22-24 Beyaz Sinyal Lambası Ledli	SIL22-24 White Signal Lamp with LED	24V AC/DC	○	25



SIL22-24 Kırmızı/Red



SIL22-220 Yeşil/Green



SIL22-220 Sarı/Yellow



SIL22-220 Mavi/Blue



SIL22-24 Beyaz/White

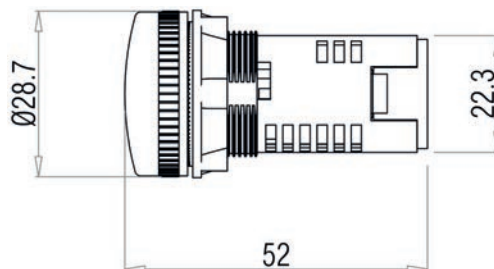

## Yaylı Kumanda Butonları - Ø22 mm

Push Buttons Spring Return - Ø22 mm



Ürün Kodu Product Code	Ürün Adı Product Name	Kontakt Contact	Renk Color	Amb. Mik. Pack. Qty (Adet/Pcs.)
8025078002	PSR-1C Kırmızı Düz Yaylı Tip 1 NK	1 NK	Red	15
8025078075	PSR-1O Yeşil Düz Yaylı Tip 1 NA	1 NA	Green	15
8025078104	PSR-1O Sarı Düz Yaylı Tip 1 NA	1 NA	Yellow	15
8025078106	PSR-1O Mavi Düz Yaylı Tip 1 NA	1 NA	Blue	15
8025078109	PSR-1O Beyaz Düz Yaylı Tip 1 NA	1 NA	White	15
8025078100	PSR-1O Siyah Düz Yaylı Tip 1 NA	1 NA	Black	15

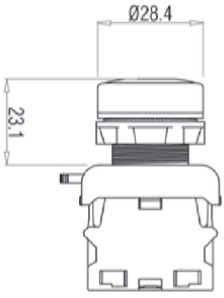

PSR-10 Sarı/Yellow



PSR-1C Kırmızı/Red



PSR-1O Yeşil/Green

## Silikon Kılıf - Ø22 mm

Silicon Cover - Ø22 mm

Ürün Kodu Product Code	Ürün Adı Product Name	Amb. Mik. Pack. Qty (Adet/Pcs.)
8025078000	PSR-IP Şeffaf Silikon Buton Koruma Kılıfı	15





## LED'li Yaylı Kumanda Butonları - Ø 22 mm

Push Buttons Spring Return LED - Ø 22 mm



Ürün Kodu Product Code	Ürün Adı Product Name	Nominal Gerilim (V) Nominal Voltage (V)	Renk Color	Amb. Mik. Pack. Qty (Adet/Pcs.)	
8025078022	PSRL-1C 220 Kırmızı Düz Yaylı Tip 1 NK Ledli	PSRL-1C 220 Red Spring Return 1 NC with LED	220 V AC/DC	●	15
8025078085	PSRL-1O 220 Yeşil Düz Yaylı Tip 1 NA Ledli	PSRL-1O 220 Green Spring Return 1 NO with LED	220 V AC/DC	●	15
8025078224	PSRL-1O 220 Sarı Düz Yaylı Tip 1 NA Ledli	PSRL-1O 220 Yellow Spring Return 1 NO with LED	220 V AC/DC	●	15
8025078226	PSRL-1O 220 Mavi Düz Yaylı Tip 1 NA Ledli	PSRL-1O 220 Blue Spring Return 1 NO with LED	220 V AC/DC	●	15
8025078229	PSRL-1O 220 Beyaz Düz Yaylı Tip 1 NA Ledli	PSRL-1O 220 White Spring Return 1 NO with LED	220 V AC/DC	○	15
8025078032	PSRL-1C 110 Kırmızı Düz Yaylı Tip 1 NK Ledli	PSRL-1C 110 Red Spring Return 1 NC with LED	110 V AC/DC	●	15
8025078095	PSRL-1O 110 Yeşil Düz Yaylı Tip 1 NA Ledli	PSRL-1O 110 Green Spring Return 1 NO with LED	110 V AC/DC	●	15
8025078234	PSRL-1O 110 Sarı Düz Yaylı Tip 1 NA Ledli	PSRL-1O 110 Yellow Spring Return 1 NO with LED	110 V AC/DC	●	15
8025078236	PSRL-1O 110 Mavi Düz Yaylı Tip 1 NA Ledli	PSRL-1O 110 Blue Spring Return 1 NO with LED	110 V AC/DC	●	15
8025078239	PSRL-1O 110 Beyaz Düz Yaylı Tip 1 NA Ledli	PSRL-1O 110 White Spring Return 1 NO with LED	110 V AC/DC	○	15
8025078042	PSRL-1C 48 Kırmızı Düz Yaylı Tip 1 NK Ledli	PSRL-1C 48 Red Spring Return 1 NC with LED	48 V AC/DC	●	15
8025078205	PSRL-1O 48 Yeşil Düz Yaylı Tip 1 NA Ledli	PSRL-1O 48 Green Spring Return 1 NO with LED	48 V AC/DC	●	15
8025078204	PSRL-1O 48 Sarı Düz Yaylı Tip 1 NA Ledli	PSRL-1O 48 Yellow Spring Return 1 NO with LED	48 V AC/DC	●	15
8025078206	PSRL-1O 48 Mavi Düz Yaylı Tip 1 NA Ledli	PSRL-1O 48 Blue Spring Return 1 NO with LED	48 V AC/DC	●	15
8025078209	PSRL-1O 48 Beyaz Düz Yaylı Tip 1 NA Ledli	PSRL-1O 48 White Spring Return 1 NO with LED	48 V AC/DC	○	15
8025078052	PSRL-1C 24 Kırmızı Düz Yaylı Tip 1 NK Ledli	PSRL-1C 24 Red Spring Return 1 NC with LED	24 V AC/DC	●	15
8025078215	PSRL-1O 24 Yeşil Düz Yaylı Tip 1 NA Ledli	PSRL-1O 24 Green Spring Return 1 NO with LED	24 V AC/DC	●	15
8025078214	PSRL-1O 24 Sarı Düz Yaylı Tip 1 NA Ledli	PSRL-1O 24 Yellow Spring Return 1 NO with LED	24 V AC/DC	●	15
8025078216	PSRL-1O 24 Mavi Düz Yaylı Tip 1 NA Ledli	PSRL-1O 24 Blue Spring Return 1 NO with LED	24 V AC/DC	●	15
8025078219	PSRL-1O 24 Beyaz Düz Yaylı Tip 1 NA Ledli	PSRL-1O 24 White Spring Return 1 NO with LED	24 V AC/DC	○	15

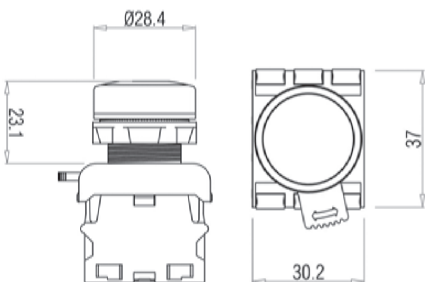

PSRL-1C Kırmızı/Red



PSRL-1O Yeşil/Green



PSRL-1O Mavi/Blue

## Çiftli, Yaylı Kumanda Butonları - Ø 22 mm

Double Spring Push Button - Ø22 mm



Ürün Kodu Product Code	Ürün Adı Product Name	Kontakt Contact	Renk Color	Amb. Mik. Pack. Qty (Adet/Pcs.)
8025078302	<b>DSR-1C10 Çiftli Yaylı Tip 1NA+1NK</b>	DSR-1C10 Double Spring Return 1NO+1NC	1 NA + 1 NK	10
8025078312	<b>DSRL-1C10 220 Çiftli Yaylı Tip 1NA+1NK Ledli</b>	DSRL-1C10 220 Double Spring Return 1NO+1NC with LED	1 NA + 1 NK	10
8025078362	<b>DSRL-1C10 110 Çiftli Yaylı Tip 1NA+1NK Ledli</b>	DSRL-1C10 110 Double Spring Return 1NO+1NC with LED	1 NA + 1 NK	10
8025078372	<b>DSRL-1C10 24 Çiftli Yaylı Tip 1NA+1NK Ledli</b>	DSRL-1C10 24 Double Spring Return 1NO+1NC with LED	1 NA + 1 NK	10
8025079002	<b>DSR-20 Ciftli yayli Tip 2NA</b>	DSR-20 Double Spring Return 2NO	2 NA	10
8025079012	<b>DSRL-20 220 Ciftli yayli Tip 2NA Ledli</b>	DSRL-20 220 Double Spring Return 2NO with LED	2 NA	10
8025079062	<b>DSRL-20 110 Ciftli yayli Tip 2NA Ledli</b>	DSRL-20 110 Double Spring Return 2NO with LED	2 NA	10
8025079072	<b>DSRL-20 24 Ciftli yayli Tip 2NA Ledli</b>	DSRL-20 24 Double Spring Return 2NO with LED	2 NA	10

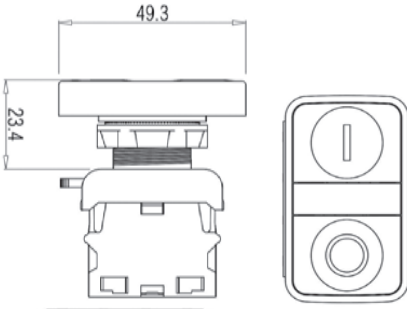

DSR-1C10

## Acil Stop Kumanda Butonları - Ø 22 mm

Emergency Stop - Ø 22 mm



Ürün Kodu Product Code	Ürün Adı Product Name	Kontakt Contact	Renk Color	Amb. Mik. Pack. Qty (Adet/Pcs.)
8025078012	<b>EPB-1C Acil Stop 1 NK</b>	EPB-1C Emergency Stop 1 NC	1NK	10
8025078880	<b>C-EPB - Acil Stop Koruma Kılıfı</b>	<b>C-EPB - Emergency Stop Protection Cover</b>	--	1

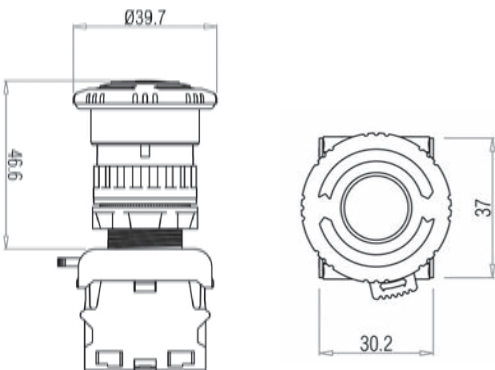

C-EPB



EPB-1C

## Kalıcı Tip Seçici Butonlar - Ø 22 mm

Selector Switches Maintained - Ø22 mm



Ürün Kodu Product Code	Ürün Adı Product Name	Kontak Contac	Renk Color	Pozisyon Position	Amb. Mik. Pack. Qty (Adet/Pcs.)
8025078500	<b>SSP-10 Kalıcı 0-1 Seçici Buton</b>	1 NA	●	<pre> 0   1  \ /   </pre>	12
8025078501	<b>SSP-1C10 Kalıcı 1-0-2 Seçici Buton</b>	1 NA + 1NK	●	<pre> 1   0   2  \ / \ /   </pre>	12
8025078510	<b>SSP-20 Kalıcı 1-0-2 Seçici Buton</b>	2 NA	●	<pre> 1   0   2  \ / \ /   </pre>	12

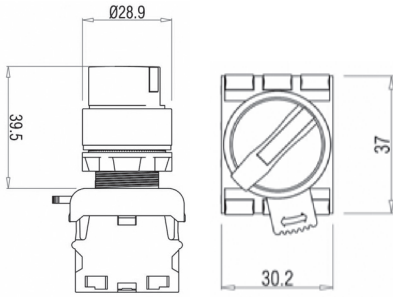

SSP-20

## LED'li Kalıcı Tip Seçici Butonlar - Ø 22 mm

Selector Switches Maintained with LED - Ø22 mm



Ürün Kodu Product Code	Ürün Adı Product Name	Nominal Gerilim (V) Nominal Voltage (V)	Renk Color	Pozisyon Position	Amb. Mik. Pack. Qty (Adet/Pcs.)
8025078602	<b>SSP-10 220 L Kırmızı Kalıcı Işıklı 0-1 Seçici Buton</b>	220 V AC/DC	●	<pre> 0   1  \ /   </pre>	12
8025078605	<b>SSP-10 220 L Yeşil Kalıcı Işıklı 0-1 Seçici Buton</b>	220 V AC/DC	●	<pre> 0   1  \ /   </pre>	12
8025078604	<b>SSP-10 220 L Sarı Kalıcı Işıklı 0-1 Seçici Buton</b>	220 V AC/DC	●	<pre> 0   1  \ /   </pre>	12
8025078622	<b>SSP-20 220 L Kırmızı Kalıcı Işıklı 1-0-2 Seçici Buton</b>	220 V AC/DC	●	<pre> 1   0   2  \ / \ /   </pre>	12
8025078615	<b>SSP-20 220 L Yeşil Kalıcı Işıklı 1-0-2 Seçici Buton</b>	220 V AC/DC	●	<pre> 1   0   2  \ / \ /   </pre>	12
8025078614	<b>SSP-20 220 L Sarı Kalıcı Işıklı 1-0-2 Seçici Buton</b>	220 V AC/DC	●	<pre> 1   0   2  \ / \ /   </pre>	12

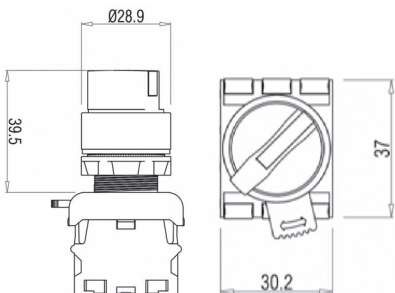

SSP-10 220 L Yeşil/Green



SSP-10 220 L Kırmızı/Red

## LED'li Tip Yay Dönüflü Seçi Butonlar - Ø 22 mm

Selector Switch Momentary with LED - Ø22 mm



Ürün Kodu Product Code	Ürün Adı Product Name	Nominal Gerilim (V) Nominal Voltage (V)	Renk Color	Pozisyon Position	Amb. Mik. Pack. Qty (Adet/Pcs.)
8025078402	<b>SSM-10 220 L Kırmızı Yay Dönüflü Işıklı 0-1 Seçi Buton</b> SSM-10 220 L, 1NO 90° with LED	220 V AC/DC	Red	0 1	12
8025078405	<b>SSM-10 220 L Yeşil Yay Dönüflü Işıklı 0-1 Seçi Buton</b> SSM-10 220 L, 2 position 1NO 90° with LED	220 V AC/DC	Green	0 1	12
8025078404	<b>SSM-10 220 L Sarı Yay Dönüflü Işıklı 0-1 Seçi Buton</b> SSM-10 220 L, 2 position 1NO 90° with LED	220 V AC/DC	Yellow	0 1	12
8025078422	<b>SSM-20 220 L Kırmızı Yay Dönüflü Işıklı 1-0-2 Seçi Buton</b> SSM-20 220 L, 3 position 2NC 60° with LED	220 V AC/DC	Red	1 0 2	12
8025078415	<b>SSM-20 220 L Yeşil Yay Dönüflü Işıklı 1-0-2 Seçi Buton</b> SSM-20 220 L, 3 position 2NO 60° with LED	220 V AC/DC	Green	1 0 2	12
8025078424	<b>SSM-20 220 L Sarı Yay Dönüflü Işıklı 1-0-2 Seçi Buton</b> SSM-20 220 L, 3 position 2NO 60° with LED	220 V AC/DC	Yellow	1 0 2	12

## Yay Dönüflü Seçi Butonlar - Ø 22 mm

Selector Switch Momentary - Ø22 mm



Ürün Kodu Product Code	Ürün Adı Product Name	Kontakt Contact	Renk Color	Pozisyon Position	Amb. Mik. Pack. Qty (Adet/Pcs.)
8025078320	<b>SSM-10 Yay Dönüflü 0-1 Seçi Buton</b> SSM-10, 2 position 1NO 90°	1 NA	Black	0 1	12
8025078330	<b>SSM-20 Yay Dönüflü 1-0-2 Seçi Buton</b> SSM-20, 3 position 2NO 60°	2 NA	Black	1 0 2	12

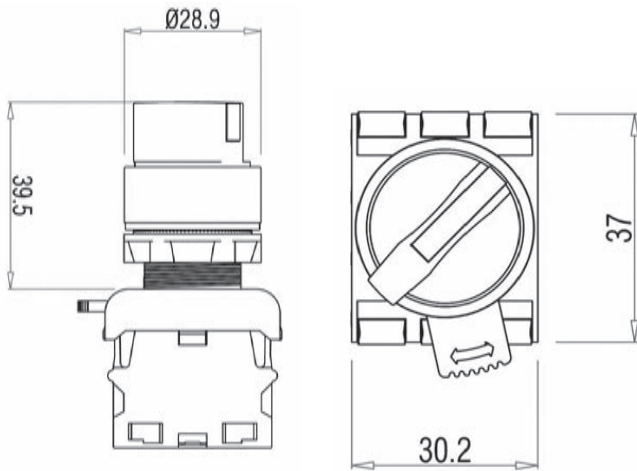

SMM-10

LED li Kalıcı ve Yaylı Tip Seçi Butonların 110V AC/DC ve 24V AC/DC Nominal Gerilimleri için lütfen satış temsilcinizle irtibata geçiniz.

## Kontak Blok Tipleri

### Contact Block Types



Ürün Kodu Product Code	Ürün Adı Product Name	Kontak Contact	Amb. Mik. Pack. Qty (Adet/Pcs.)
8025078800	<b>CNT-O NA Kontak</b>	CNT-O NO Contact	50
8025078810	<b>CNT-C NK Kontak</b>	CNT-C NC Contact	50
8025078820	<b>CNT-S Işık Kontak Blok</b>	CNT-S Signal Contact	50

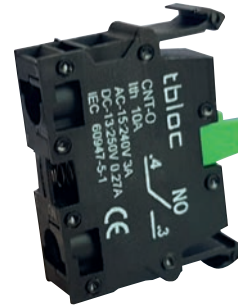
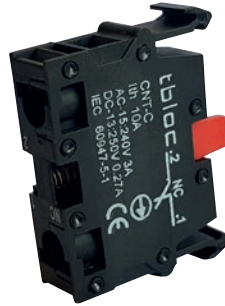
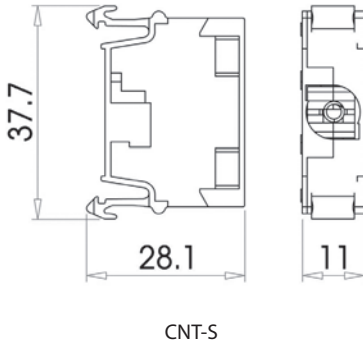
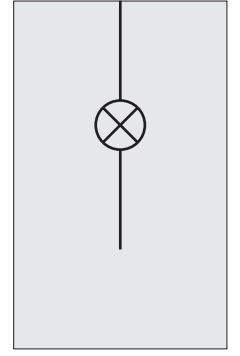
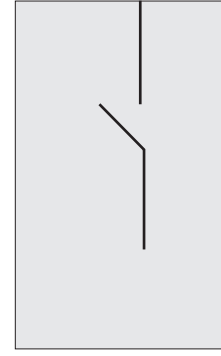
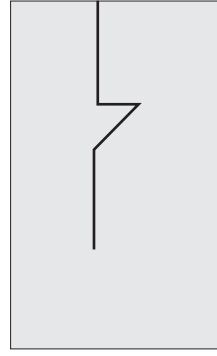
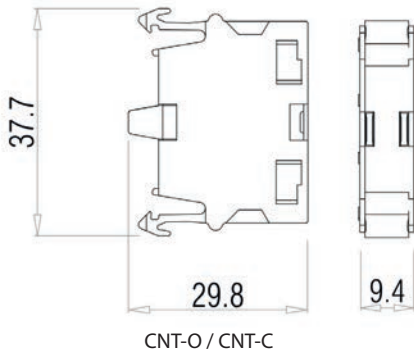

### Teknik Bilgiler / Technical Information

Standart / Standard	IEC 60947-5-1
Çalışma Sıcaklığı min/maks. / Operating Temperature min/max (°C)	-5 / +40
Kirlilik Derecesi / Pollution Severity	3
Yalıtım Gerilimi / Rated Insulation Voltage (V)	400
Darbe Beyan Gerilimi / Rated Impulse Withstand Voltage (kV)	4
Klasik Açık hava Termal Akım / Conventional Thermal Current (A)	10
Kullanım Sınıfı / Utilization Category	AC 15
<b>Nominal Çalışma Gerilimi / Rated Operational Voltage (V)</b>	<b>Nominal Çalışma Akımı / Rated Operational Current (A)</b>
380	1,9
240	3
120	6

# tbloc

Electrical & Electronic Manufacturing

YENİ ÜRÜN  
NEW PRODUCT

## ENDÜSTRİYEL ve PLC RÖLELER

İnce Tip Endüstriyel Röle

Kalın Tip Endüstriyel Röle

Vida Bağlantılı PLC Röle

Röle Soketi

Röle Tutucu, Ekstra Klipsler

Harici Led Modülleri

Markalama

## INDUSTRIAL and INTERFACE RELAYS

Compact Industrial Relays

Plug-In Industrial Relays

Screw Type Interface Relay

Relay Socket

Relay Holder, Support Clips

External Led Modul

Marking



## 1CO 10A İnce Tip Endüstriyel Röle Compact Industrial Relay



Ürün Kodu Product Code	Ürün Adı Product Name	Açıklama Explanation	Amb. Mik. Pack. Qty (Adet/Pcs.)
8036311200	<b>TRS LT-1C-12A-12 V DC</b>	1CO, 10A, 12V DC, LED+Test Butonlu Kompakt Röle / Test Button Compact Relay	20
8036311210	<b>TRS LT-1C-12A-24 V DC</b>	1CO, 10A, 24V DC, LED+Test Butonlu Kompakt Röle / Test Button Compact Relay	20
8036311220	<b>TRS LT-1C-12A-48 V DC</b>	1CO, 10A, 48V DC, LED+Test Butonlu Kompakt Röle / Test Button Compact Relay	20
8036311230	<b>TRS LT-1C-12A-110 V DC</b>	1CO, 10A, 110V DC, LED+Test Butonlu Kompakt Röle / Test Button Compact Relay	20
8036311240	<b>TRS LT-1C-12A-24 V AC</b>	1CO, 10A, 24V AC, LED+Test Butonlu Kompakt Röle / Test Button Compact Relay	20
8036311270	<b>TRS LT-1C-12A-230 V AC</b>	1CO, 10A, 230V AC, LED+Test Butonlu Kompakt Röle / Test Button Compact Relay	20

## Aksesuarlar Accessories



Ürün Kodu Product Code	Ürün Adı Product Name	Açıklama Explanation	Amb. Mik. Pack. Qty (Adet/Pcs.)
8036012000	<b>TS-V TRS 1C</b>	1 kontaklı soketi / 1C Relay Socket	20
8036330100	<b>MARK- TRS</b>	Etiket (Röle ile birlikte set olarak verilmektedir) / Marking Tag (Arriving as set with relay)	50
8036330060	<b>LED FC R 6-24 VAC/DC</b>	Harici Led Modülü / External Led Modul	5
8036330000	<b>CP- TRS</b>	Plastik Röle Tutucu / Plastic Relay Holder	20
8036331003	<b>JP TS-P-2C-8</b>	TRS Serisi için 8 Kutuplu Köprü / 8 pole jumper for TRS Series	5

## 2CO 8A İnce Tip Endüstriyel Röle Compact Industrial Relay



EAC

Ürün Kodu Product Code	Ürün Adı Product Name	Açıklama Explanation	Amb. Mik. Pack. Qty (Adet/Pcs.)
8036312800	<b>TRS LT-2C-8A-12 V DC</b>	2CO, 8A, 12V DC, LED+Test Butonlu Kompakt Röle / Test Button Compact Relay	20
8036312810	<b>TRS LT-2C-8A-24 V DC</b>	2CO, 8A, 24V DC, LED+Test Butonlu Kompakt Röle / Test Button Compact Relay	20
8036312820	<b>TRS LT-2C-8A-48 V DC</b>	2CO, 8A, 48V DC, LED+Test Butonlu Kompakt Röle / Test Button Compact Relay	20
8036312830	<b>TRS LT-2C-8A-110 V DC</b>	2CO, 8A, 110V DC, LED+Test Butonlu Kompakt Röle / Test Button Compact Relay	20
8036312840	<b>TRS LT-2C-8A-24 V AC</b>	2CO, 8A, 24V AC, LED+Test Butonlu Kompakt Röle / Test Button Compact Relay	20
8036312860	<b>TRS LT-2C-8A-115 V AC</b>	2CO, 8A, 115V AC, LED+Test Butonlu Kompakt Röle / Test Button Compact Relay	20
8036312870	<b>TRS LT-2C-8A-230 V AC</b>	2CO, 8A, 230V AC, LED+Test Butonlu Kompakt Röle / Test Button Compact Relay	20

## Aksesuarlar Accessories



EAC

Ürün Kodu Product Code	Ürün Adı Product Name	Açıklama Explanation	Amb. Mik. Pack. Qty (Adet/Pcs.)
8036012001	<b>TS-V TRS 2C</b>	2 kontaklı soketi / 2C Relay Socket	20
8036330100	<b>MARK- TRS</b>	Etiket (Röle ile birlikte set olarak verilmektedir) / Marking Tag (Arriving as set with relay)	50
8036330060	<b>LED FC R 6-24 VAC/DC</b>	Harici Led Modülü / External Led Modul	5
8036330000	<b>CP- TRS</b>	Plastik Röle Tutucu / Plastic Relay Holder	20
8036331003	<b>JP TS-P-2C-8</b>	TRS Serisi için 8 Kutuplu Köprü / 8 pole jumper for TRS Series	5



## 2CO 10A Kalın Tip Endüstriyel Röle Plug-In Industrial Relay



Ürün Kodu Product Code	Ürün Adı Product Name	Açıklama Explanation	Amb. Mik. Pack. Qty (Adet/Pcs.)
8036322010	<b>TRB LT-2C-10A-24 V DC</b>	2CO, 10A, 24V DC, LED+Test Butonlu Röle / Test Button Plug-In Industrial Relay	20
8036322020	<b>TRB LT-2C-10A-48 V DC</b>	2CO, 10A, 48V DC, LED+Test Butonlu Röle / Test Button Plug-In Industrial Relay	20
8036322030	<b>TRB LT-2C-10A-110 V DC</b>	2CO, 10A, 110V DC, LED+Test Butonlu Röle / Test Button Plug-In Industrial Relay	20
8036322040	<b>TRB LT-2C-10A-24 V AC</b>	2CO, 10A, 24V AC, LED+Test Butonlu Röle / Test Button Plug-In Industrial Relay	20
8036322050	<b>TRB LT-2C-10A-48 V AC</b>	2CO, 10A, 48V AC, LED+Test Butonlu Röle / Test Button Plug-In Industrial Relay	20
8036322060	<b>TRB LT-2C-10A-115 V AC</b>	2CO, 10A, 115V AC, LED+Test Butonlu Röle / Test Button Plug-In Industrial Relay	20
8036322070	<b>TRB LT-2C-10A-230 V AC</b>	2CO, 10A, 230V AC, LED+Test Butonlu Röle / Test Button Plug-In Industrial Relay	20

## 4CO 5A Kalın Tip Endüstriyel Röle Plug-In Industrial Relay



Ürün Kodu Product Code	Ürün Adı Product Name	Açıklama Explanation	Amb. Mik. Pack. Qty (Adet/Pcs.)
8036324500	<b>TRB LT-4C-5A-12 V DC</b>	4CO, 5A, 12V DC, LED+Test Butonlu Röle / Test Button Plug-In Industrial Relay	20
8036324510	<b>TRB LT-4C-5A-24 V DC</b>	4CO, 5A, 24V DC, LED+Test Butonlu Röle / Test Button Plug-In Industrial Relay	20
8036324520	<b>TRB LT-4C-5A-48 V DC</b>	4CO, 5A, 48V DC, LED+Test Butonlu Röle / Test Button Plug-In Industrial Relay	20
8036324530	<b>TRB LT-4C-5A-110 V DC</b>	4CO, 5A, 110V DC, LED+Test Butonlu Röle / Test Button Plug-In Industrial Relay	20
8036324540	<b>TRB LT-4C-5A-24 V AC</b>	4CO, 5A, 24V AC, LED+Test Butonlu Röle / Test Button Plug-In Industrial Relay	20
8036324550	<b>TRB LT-4C-5A-48 V AC</b>	4CO, 5A, 48V AC, LED+Test Butonlu Röle / Test Button Plug-In Industrial Relay	20
8036324560	<b>TRB LT-4C-5A-115 V AC</b>	4CO, 5A, 110V AC, LED+Test Butonlu Röle / Test Button Plug-In Industrial Relay	20
8036324570	<b>TRB LT-4C-5A-230 V AC</b>	4CO, 5A, 220V AC, LED+Test Butonlu Röle / Test Button Plug-In Industrial Relay	20

## Aksesuarlar Accessories



Ürün Kodu Product Code	Ürün Adı Product Name	Açıklama Explanation	Amb. Mik. Pack. Qty (Adet/Pcs.)
8036024002	<b>TS-V TRB 4C</b>	2 & 4 Kontaklı Röle Soketi / 2C & 4C Relay Socket	10
8036330101	<b>MARK- TRB</b>	Etiket (Röle ile birlikte set olarak verilmektedir) / Marking Tag(Arriving as set with relay)	50
8036330060	<b>LED FC R 6-24 VAC/DC</b>	Harici Led Modülü / External Led Modul	5
8036330001	<b>CP- TRB</b>	Plastik Röle Tutucu / Plastic Relay Holder	20
8036331005	<b>JP TS-P-4C-5</b>	TRB Serisi için 5 Kutuplu Köprü / 5 pole jumper for TRS Series	5

## Vida Bağlantılı 1CO PLC Röleler Screw Type 1CO PLC Relays

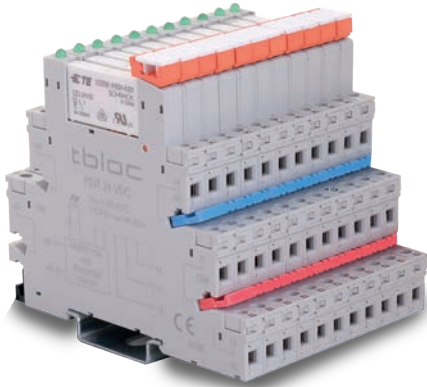

Ürün Kodu Product Code	Ürün Adı Product Name	Açıklama Explanation	Amb. Mik. Pack. Qty (Adet/Pcs.)
8031241500	<b>PINT-1C 24 V DC - 6A</b>	1CO, 24 V DC PLC Röle + Soket / Relay and Socket	20
8031241502	<b>PINT-1C 12 VAC/DC - 6A</b>	1CO, 12 VAC/DC Röle + Soket / Relay and Socket	20
8031241510	<b>PINT-1C 24 VAC/DC - 6A</b>	1CO, 24 VAC/DC Röle + Soket / Relay and Socket	20
8031241503	<b>PINT-1C 48 VAC/DC - 6A</b>	1CO, 48 VAC/DC Röle + Soket / Relay and Socket	20
8031241511	<b>PINT-1C 60 VAC/DC - 6A</b>	1CO, 60 VAC/DC Röle + Soket / Relay and Socket	20
8031241512	<b>PINT-1C 110 VAC/DC - 6A</b>	1CO, 110 VAC/DC Röle + Soket / Relay and Socket	20
8031241513	<b>PINT-1C 230 VAC/DC - 6A</b>	1CO, 230 VAC/DC Röle + Soket / Relay and Socket	20

## Vida Bağlantılı 2CO PLC Röleler Screw Type 2CO PLC Relays



EAC

Ürün Kodu Product Code	Ürün Adı Product Name	Açıklama Explanation	Amb. Mik. Pack. Qty (Adet/Pcs.)
8031241540	<b>PINT-2C 24 V DC - 8A</b>	2CO, 24 V DC PLC Röle + Soket / Relay and Socket	20
8031241541	<b>PINT-2C 24 V AC/DC - 8A</b>	2CO, 24 V AC/DC Röle + Soket / Relay and Socket	20
8031241542	<b>PINT-2C 48 V AC/DC - 8A</b>	2CO, 48 V AC/DC Röle + Soket / Relay and Socket	20
8031241543	<b>PINT-2C 110 V AC/DC - 8A</b>	2CO, 110 V AC/DC Röle + Soket / Relay and Socket	20
8031241544	<b>PINT-2C 230 V AC/DC - 8A</b>	2CO, 230 V AC/DC Röle + Soket / Relay and Socket	20

## Aksesuarlar Accessories

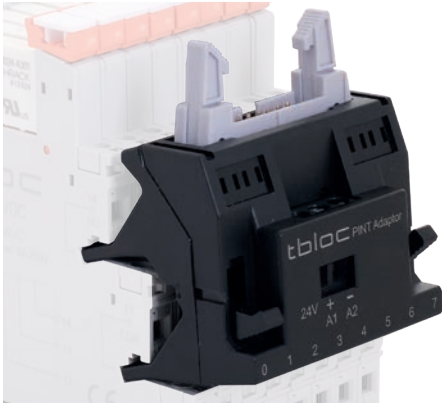

EAC

Ürün Kodu Product Code	Ürün Adı Product Name	Açıklama Explanation	Amb. Mik. Pack. Qty (Adet/Pcs.)
8031241533	<b>PINT GİRİŞ ADAPTÖRÜ</b>	PINT 1C Serisi PLC Röle Adaptör / Adaptor for PINT 1C PLC Relays	20

## Aksesuarlar Accessories

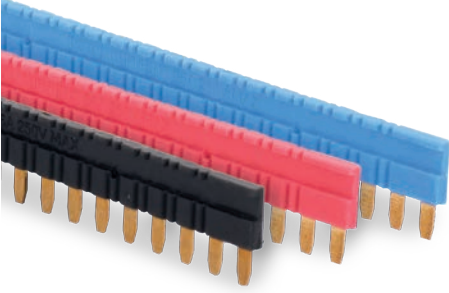

EAC

Ürün Kodu Product Code	Ürün Adı Product Name	Açıklama Explanation	Amb. Mik. Pack. Qty (Adet/Pcs.)
8036331000	<b>JP PINT-20-MAVİ</b>	PINT 1C Serisi için 20 Kutuplu Köprü / 20 Pole jumper for PINT 1C (Blue)	5
8036331001	<b>JP PINT-20-SİYAH</b>	PINT 1C Serisi için 20 Kutuplu Köprü / 20 Pole jumper for PINT 1C (Black)	5
8036331002	<b>JP PINT-20-KIRMIZI</b>	PINT 1C Serisi için 20 Kutuplu Köprü / 20 Pole jumper for PINT 1C (Red)	5

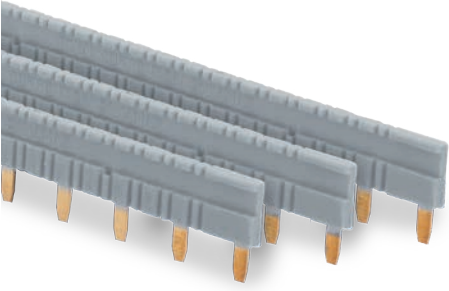

EAC

Ürün Kodu Product Code	Ürün Adı Product Name	Açıklama Explanation	Amb. Mik. Pack. Qty (Adet/Pcs.)
8036331007	<b>JP PINT-8-GRİ</b>	PINT 2C Serisi için 8 Kutuplu Köprü / 8 Pole jumper for PINT 2C (Gray)	5





**MERKEZ / HEADQUARTER**

**Tbloc Elektrik Elektronik  
Sanayi ve Ticaret A.Ş.**

29 Ekim Mahallesi  
10001 Sokak No: 50/4  
35663 Menemen İzmir Turkey

Tel: +90 232 833 26 96  
Fax: +90 232 833 26 97

[info@tbloc.com.tr](mailto:info@tbloc.com.tr)  
[www.tbloc.com.tr](http://www.tbloc.com.tr)

