

tbloc

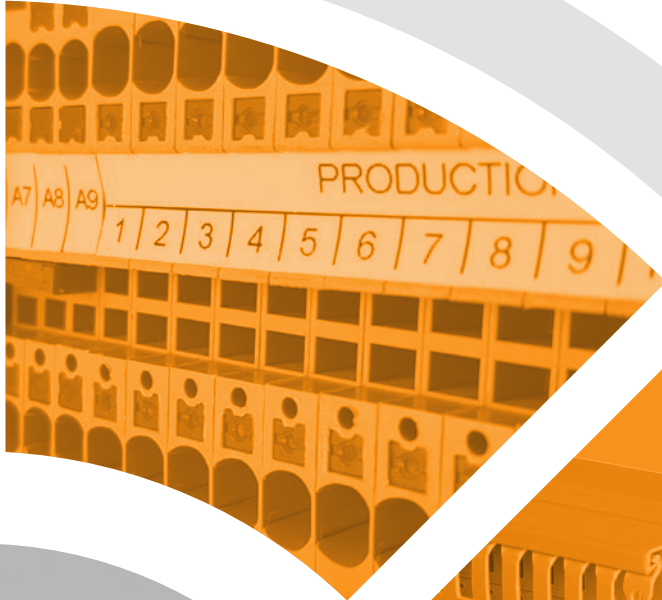

Product Catalog
Catálogo de productos

Index

Tabla de contenido

Screw Type Terminal Blocks	Bornes de tipo tornillo	06 - 25
Push-in Terminal Blocks	Bornes de tipo Push-in	26 - 31
Terminal Strips	Tiras de bornes	32
End Bracket	Topes finales	32
Group Marker	Marcadores de grupo	33
Marker Holder	Soporte para Marcador	33
End Plates	Tapas finales	34
Partition plates	Placas de partición	35
Test Sockets	Terminales de prueba	36
Comb Connector	Peines de conexión	36
Cross Connections	Puentes de conexión	37
Push-in Cross Connections	Puentes de conexión tipo Push-in	38
Marking Tags	Etiquetas de marcado	39 - 42
Mounting Rails	Rieles de montaje	43
Wiring Duct and Din Rail Cutter	Cortadora de canaleta y riel Din	44
Panel Type Slotted Wiring Ducts	Canaletas ranuradas tipo panel	45 - 46
Marking Systems	Sistemas de marcado	47 - 53
Plastic Cable Ties	Bridas plásticas para cable	54
Tie Mounts and Cable Tie Tightening and Cutting Tool	Monturas de fijación y herramienta para ajuste y corte de bridas	55
Cable Lugs and Butt Terminals	Terminal tipo ojo y terminales de unión	56 - 63
End Sleeves	Terminal tipo pin	64 - 66
Led Indicators and Buttons	Indicadores LED y botones	67 - 75
Thermal Indicator Covers and Washers	Coberturas indicadoras de temperatura y arandelas	76 - 79

TBLOC is an industrial company established in January 2020 in İzmir/Turkey. Even though TBLOC is a new company, it has deep roots backed up with long years experience and knowledge. TBLOC, as a new brand in connectivity industry, is gathering all R&D, production and sales & marketing functions under one roof with the aim of becoming a global brand and supplying to international markets.

Despite TBLOC brand is being perceived as an abbreviation of Terminal Block definition, first letter “t” stands for technology and indicates our company’s long term vision.

Tbloc Corporate

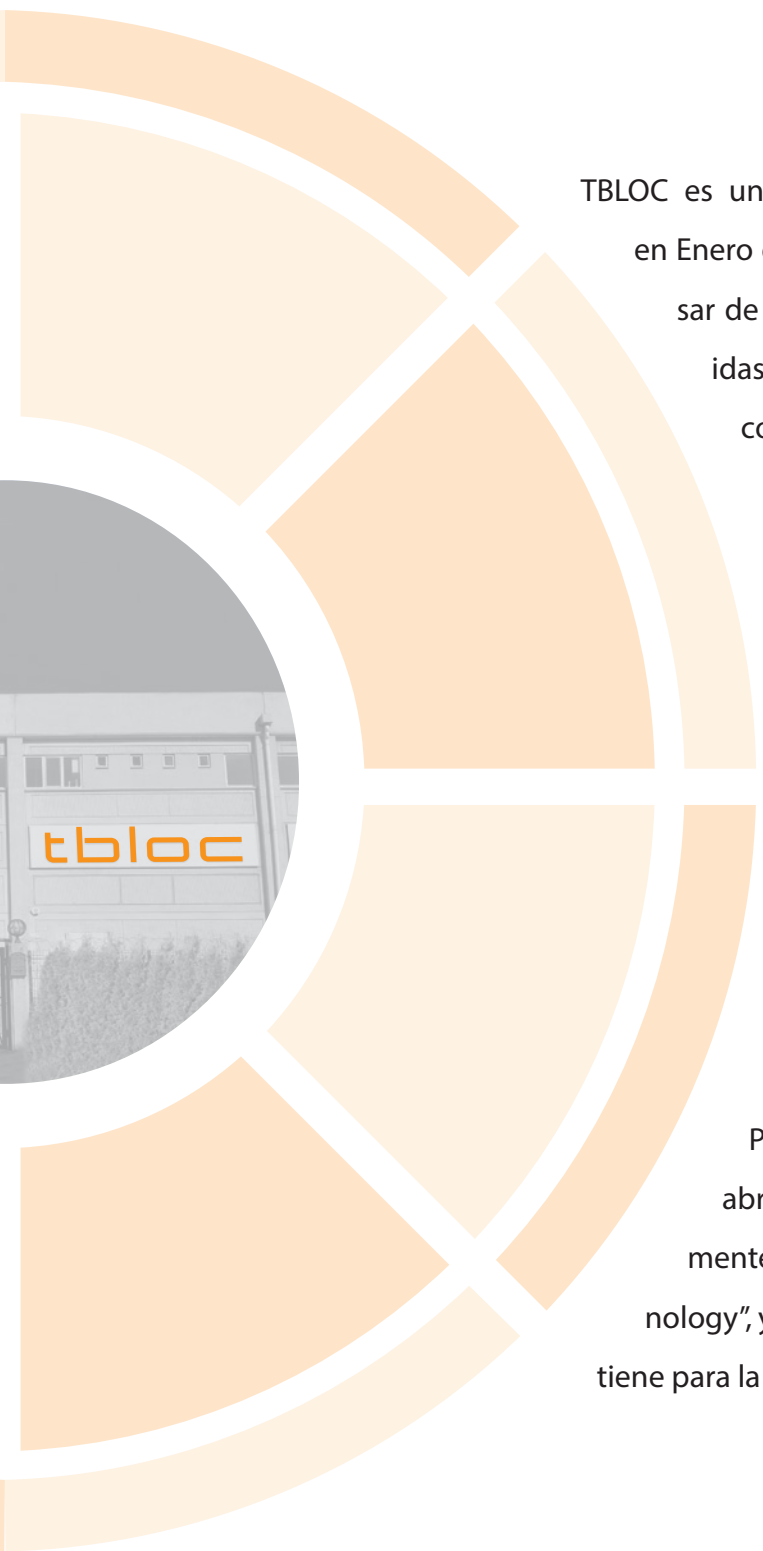

TBLOC es una compañía industrial establecida en Enero de 2020 en İzmir-Turquía que, a pesar de ser una nueva empresa, posee sólidas bases respaldadas por un amplio conocimiento y muchos años de experiencia. Como marca de reciente aparición en la industria de soluciones para conexión, TBLOC está centralizando procesos de I&D, producción, ventas y marketing bajo un mismo techo con el fin de convertirse en una compañía de talla mundial y de esta manera suplir las necesidades del mercado internacional.

Pese a que "TBLOC" se percibe como abreviatura para "Terminal Block", realmente la primera letra ("t") significa "Technology", y representa la visión a futuro que se tiene para la compañía.

Tbloc Corporativo

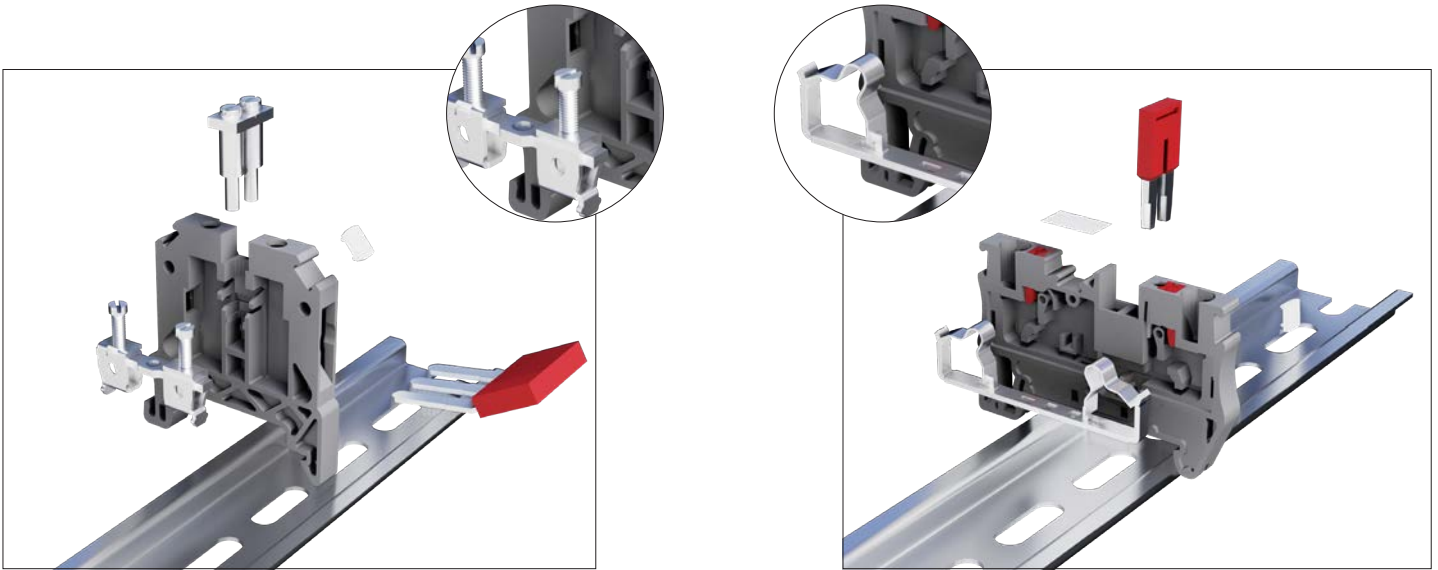

Screw Connection

Screw type connection is the classical method for terminal blocks. Reinforced clamps ensures the safe and durable connection for long time of usage.

Reliable Clamping

The connection unit (yokes) in the terminal block is made of reinforced steel, as in the screw. When the screw is tightened, the force that occurs in the connection unit creates a locking mechanism. Thanks to that, durable and safe connection is obtained.

Push-in Connection

Tbloc push-in terminal blocks provide fast assembly of cables without using a tool. With this technology, solid conductors (just stripping is enough) and flexible conductors (with end ferrules) can be assembled easily. Red buttons on top of the terminal blocks provide easy disassembly without touching conductive parts of the terminal blocks. Push-in connection is resistant to vibration hence can be used safely in many areas.

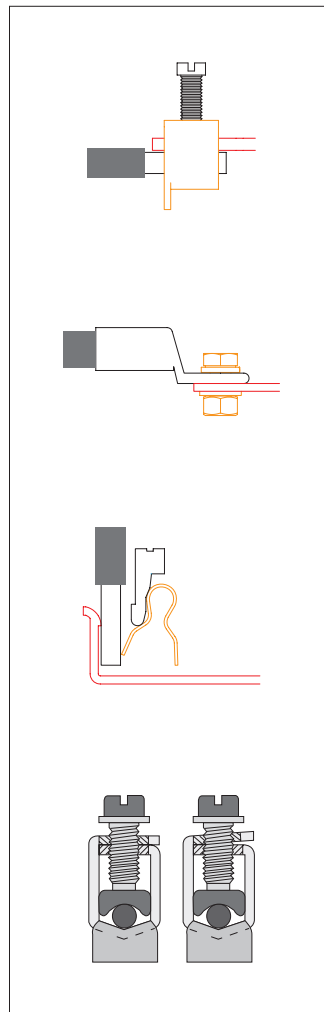

Conexión tipo tornillo

La conexión de tipo tornillo es el método clásico de conexión de borneras. El sistema reforzado brinda conexiones resistentes y seguras para usos a largo plazo.

Fijación segura

El elemento de conexión (horquilla) en la bornera está hecho de acero reforzado, como en el tornillo. Debido a lo anterior, al apretarse el tornillo, la fuerza aplicada crea un mecanismo de bloqueo que ofrece conexiones seguras y duraderas.

Conexión tipo Push-in

Los bornes tipo push-in de Tbloc permiten conexiones rápidas evitando el uso de herramientas. Con esta tecnología, los conductores sólidos (Solo deben estar pelados) y los conductores flexibles (con terminal de conexión) pueden conectarse fácilmente. Los botones rojos en la parte superior de la bornera permiten una sencilla desconexión y evitan el contacto de las partes conductoras de la pieza. Este tipo de conexiones es resistente a vibraciones, por lo que puede usarse de forma segura en múltiples tipos de aplicaciones.

Screw Type Terminal Blocks Bornes de tipo tornillo

TBL Series Feed Through Terminal Block
Bornes de paso serie TBL



Product Name / Nombre de producto								
Order No. / No. de orden.								
Packing Qty / Pzs. por paquete.								
Rated Values / Valores nominales								
IEC 60947-7-1								
IEC/EN 60079-7								
Connection Information / Información de conexión								
Cross-Section / Sección transversal (mm ²)								
Solid Conductor Cross-section min / Sección transversal conductor sólido mín (mm ²)-(mín-máx)								
Stranded Conductor Cross-Section / Sección transversal conductor trenzado (mm ²)-(mín-máx)								
Flexible Conductor Cross-Section / Sección transversal conductor flexible (mm ²)-(mín-máx)								
AWG								
Descriptions / Descripción								
Insulation Stripping Length / Longitud de pelado del aislante (mm)								
Tightening Torque (N.m) / Torque de fijación								
Screw Diameter / Diámetro del tornillo								
Rated Impulse Voltage / Voltaje de impulso nominal (Kv)								
Pollution D./ Voltage CAT/ Material Group / Grado de contaminación / Voltaje (CAT) / Grupo de material								
Accessories / Accesorios								
Din Rail / Riel DIN								
End Stopper / Tope final								
End Plate / Tapa final								
Partition Plate / Placa de partición								
Small Partition Plate / Placa de partición pequeña								
Cross Connection / Puentes de conexión								
Comb Connector / Peine de conexión								
Test Plug / Terminal de prueba								
Marking Tags / Etiquetas de marcado								
Group Label / Etiqueta de grupo								
Screwdriver / Perillero								
Color codes / Código de colores								
800009900....	...0	...1	...2	...3	...4	...5	...6	...9

TBL 2,5

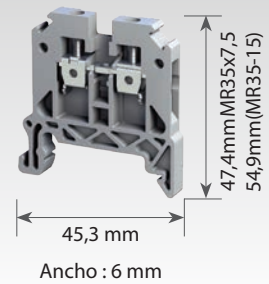

TBL 2,5		
8000099008		
100		
800 V / 24 A		
500 V / 24 A		
2,5		
0,5 -4		
0,5 -4		
0,5 -2,5		
20-12 AWG		
10		
0,6		
M2,5		
6		
3 / III / I		
Product Name Nombre de producto	Order No. No. de orden	Qty. Qty.
DR 35-7,5 S 2M	8015393407	40
DR 35-15 S 2M	8015393427	20
SS 1	8010097308	50
SS 2	8010097318	50
PS 1	8010197328	50
EPL TBL 2,5-10	8012396118	50
PR TBL 2,5-10	8012396408	100
SPR 2,5-10	8012396528	100
SCC 2,5/2	8013095023	50
SCC 2,5/3	8013095033	50
SCC 2,5/10	8013095003	10
TST 1	8014393227	50
MTG 6	8020388009	500
GM1	8014393008	50
GM2	8014393018	50
0,5x3,0		

TBL 4

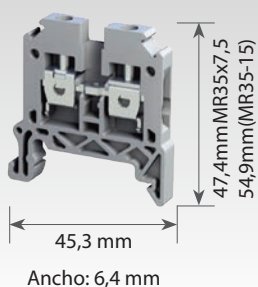

TBL 4

8000099028

100

800 V / 32 A

500 V / 32 A

4

0,5 - 6

0,5 - 6

0,5 - 4

20-10 AWG

12

0,8

M3

6

3 / III / I

TBL 6

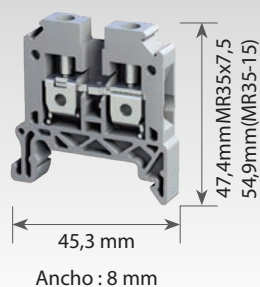

TBL 6

8000099038

80

800 V / 41 A

500 V / 41 A

6

0,5 - 10

0,5 - 10

0,5 - 6

20-8 AWG

12

1,2

M3,5

8

3 / III / I

TBL 10

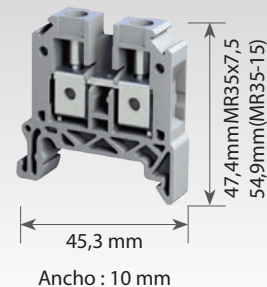

TBL 10

8000099048

60

800 V / 57 A

500 V / 57 A

10

0,5 - 16

0,5 - 16

0,5 - 10

20-6 AWG

12

1,5

M4

8

3 / III / I

Product Name Nombre de producto	Order No. No. de orden	Qty. Qty.
DR 35-7,5 S 2M	8015393407	40
DR 35-15 S 2M	8015393427	20
SS 1	8010097308	50
SS 2	8010097318	50
PS 1	8010197328	50
EPL TBL 2,5-10	8012396118	50
PR TBL 2,5 - 10	8012396408	50
SPR 2,5-10	8012396528	100
SCC 4/2	8013095123	50
SCC 4/3	8013095133	50
SCC 4/10	8013095103	10
TCC 4/2	8013094323	50
TCC 4/3	8013094333	50
TCC 4/10	8013094303	10
TST 1	8014393227	50
MTG 6,4	8020387009	500
GM1	8014393008	50
GM2	8014393018	50
0,5x3,0		

Product Name Product Name	Order No. No. de orden	Qty. Qty.
DR 35-7,5 S 2M	8015393407	40
DR 35-15 S 2M	8015393427	20
SS 1	8010097308	50
SS 2	8010097318	50
PS 1	8010197328	50
EPL TBL 2,5-10	8012396118	50
PRTBL 2,5 - 10	8012396408	50
SPR 2,5-10	8012396528	100
SCC 6/2	8013095223	50
SCC 6/3	8013095233	50
SCC 6/10	8013095203	10
TST-I 1	8014393108	50
MTG 8	8020386009	500
GM1	8014393008	50
GM2	8014393018	50
0,6x3,5		

Product Name Nombre de producto	Order No. No. de orden	Qty. Qty.
DR 35-7,5 S 2M	8015393407	40
DR 35-15 S 2M	8015393427	20
SS 1	8010097308	50
SS 2	8010097318	50
PS 1	8010197328	50
EPL TBL 2,5-10	8012396118	50
PR TBL 2,5 - 10	8012396408	50
SPR 2,5-10	8012396528	100
SCC 10/2	8013095323	50
SCC 10/3	8013095333	50
SCC 10/10	8013095303	10
TST-I 1	8014393108	50
MTG 10	8020385009	250
GM1	8014393008	50
GM2	8014393018	50
0,6x3,5		

Screw Type Terminal Blocks Bornes de tipo tornillo

TBL Series Feed Through Terminal Block Bornes de paso serie TBL



Product Name / Nombre de producto
Order No. / No. de orden.
Packing Qty / Pzs. por paquete.
Rated Values / Valores nominales
IEC 60947-7-1
IEC/EN 60079-7
Connection Information / Información de conexión
Cross-Section / Sección transversal (mm ²)
Solid Conductor Cross-section min / Sección transversal conductor sólido mín (mm ²)-(mín-máx)
Stranded Conductor Cross-Section / Sección transversal conductor trenzado (mm ²)-(mín-máx)
Flexible Conductor Cross-Section / Sección transversal conductor flexible (mm ²)-(mín-máx)
AWG
Descriptions / Descripción
Insulation Stripping Length / Longitud de pelado del aislante (mm)
Tightening Torque (N.m) / Torque de fijación
Screw Diameter / Diámetro del tornillo
Rated Impulse Voltage / Voltaje de impulso nominal (Kv)
Pollution D./ Voltage CAT/ Material Group / Grado de contaminación / Voltaje (CAT) / Grupo de material
Accessories / Accesorios
Din Rail / Riel DIN
End Stopper / Tope final
Partition Plate / Placa de partición
Cross Connection / Puentes de conexión
Test Plug / Terminal de prueba
Marking Tags / Etiquetas de marcado
Group Label / Etiqueta de grupo
Screwdriver / Perillero

TBL 16

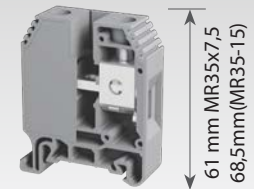

Ancho : 12,5 mm



TBL 16		
8000099058		
50		
1000 V / 76 A		
630 V / 76 A		
16		
0,5 - 16		
0,5 - 16		
0,5 - 16		
20-6 AWG		
12,3		
2,5		
M5		
8		
3 / III / I		
Product Name Nombre de producto	Order No. No. de orden	Qty. Qty.
DR 35-7,5 S 2M	8015393407	40
DR 35-15 S 2M	8015393427	20
SS 1	8010097308	50
SS 2	8010097318	50
PS 1	8010197328	50
GPR	8012396568	20
SCC 16/2	8013095423	20
SCC 16/3	8013095433	20
SCC 16/10	8013095403	10
TST-1 1	8014393108	50
TST 2	8014393237	10
MTG 10	8020385009	250
GM1	8014393008	50
GM2	8014393018	50
1,0x5,5		

Color codes / Código de colores								
800009900....	...0	...1	...2	...3	...4	...5	...6	...9

TBL 25

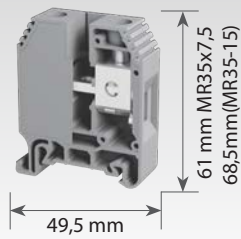

Ancho: 13,6 mm



TBL 35

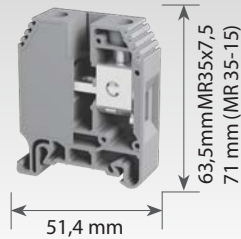

Ancho: 16,5 mm



TBL 50

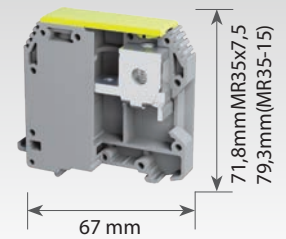

Ancho 20,1 mm



TBL 25

8000099068

50

1000 V / 101 A

630 V / 96 A

25

0,5 - 16

0,5 - 25

0,5 - 25

20-4 AWG

12,3

2,5

M5

8

3 / III / I

TBL 35

8000099078

20

1000 V / 125 A

630 V / 124 A

35

1,5 - 16

1,5 - 35

1,5 - 35

16-2 AWG

14,9

3,5

M6

8

3 / III / I

TBL 50

8000099088

20

1000 V / 150 A

800 V / 140 A

50

6 - 16

6 - 50

10 - 50

10-0 AWG

19

8

M8

8

3 / III / I

Product Name Nombre de producto	Order No. No. de orden	Qty. Qty.
DR 35-7,5 S 2M	8015393407	40
DR 35-15 S 2M	8015393427	20
SS 1	8010097308	50
SS 2	8010097318	50
PS 1	8010197328	50
GPR	8012396568	20
SCC 25/2	8013095523	20
SCC 25/3	8013095533	20
SCC 25/10	8013095503	10
TST-I 1	8014393108	10
TST 2	8014393237	10
MTG 10	8020385009	250
GM1	8014393008	50
GM2	8014393018	50
1,0x5,5		

Product Name Nombre de producto	Order No. No. de orden	Qty. Qty.
DR 35-7,5 S 2M	8015393407	40
DR 35-15 S 2M	8015393427	20
SS 1	8010097308	50
SS 2	8010097318	50
PS 1	8010197328	50
GPR	8012396568	20
SCC 35/2	8013095623	20
SCC 35/3	8013095633	20
SCC 35/10	8013095603	10
TST 4	8014393257	50
MTG 10	8020385009	250
GM1	8014393008	50
GM2	8014393018	50
1,2x6,5		

Product Name Nombre de producto	Order No. No. de orden	Qty. Qty.
DR 35-7,5 S 2M	8015393407	40
DR 35-15 S 2M	8015393427	20
SS 1	8010097308	50
SS 2	8010097318	50
PS 1	8010197328	50
GPR	8012396568	20
SCC 50/2	8013095723	10
SCC 50/3	8013095733	10
MTG 10	8020385009	250
GM1	8014393008	50
GM2	8014393018	50
Allen W. / Llave Allen 4		

Screw Type Terminal Blocks Bornes de tipo tornillo

TBL Series Feed Through Terminal Block
Bornes de paso serie TBL



Product Name / Nombre de producto
Order No. / No. de orden.
Packing Qty / Pzs. por paquete.
Rated Values / Valores nominales
IEC 60947-7-1
IEC/EN 60079-7
Connection Information / Información de conexión
Cross-Section / Sección transversal (mm ²)
Solid Conductor Cross-section min / Sección transversal conductor sólido mín (mm ²)-(mín-máx)
Stranded Conductor Cross-Section / Sección transversal conductor trenzado (mm ²)-(mín-máx)
Flexible Conductor Cross-Section / Sección transversal conductor flexible (mm ²)-(mín-máx)
AWG
Descriptions / Descripción
Insulation Stripping Length / Longitud de pelado del aislante (mm)
Tightening Torque (N.m) / Torque de fijación
Screw Diameter / Diámetro del tornillo
Rated Impulse Voltage / Voltaje de impulso nominal (Kv)
Pollution D./ Voltage CAT/ Material Group / Grado de contaminación / Voltaje (CAT) / Grupo de material
Accessories / Accesorios
Din Rail / Riel DIN
End Stopper / Tope final
Cross Connection / Puentes de conexión
Marking Tags / Etiquetas de marcado
Group Label / Etiqueta de grupo
Allen Wrench / Llave Allen

TBL 70

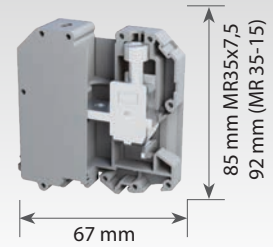

Ancho: 22 mm



TBL 70		
8000099098		
10		
1000 V / 192 A		
70		
6 - 16		
6 - 70		
10 - 70		
8-0 AWG		
19		
10		
M8		
8		
3 / III / I		
Product Name Nombre de producto	Order No. No. de orden	Qty. Qty.
DR 35-7,5 S 2M	8015393407	40
DR 35-15 S 2M	8015393427	20
SS 1	8010097308	50
SS 2	8010097318	50
PS 1	8010197328	50
SCC 70/2	8013095823	10
SCC 70/3	8013095833	10
MTG 10	8020385009	250
GM1	8014393008	50
GM2	8014393018	50
6		

TBL 95

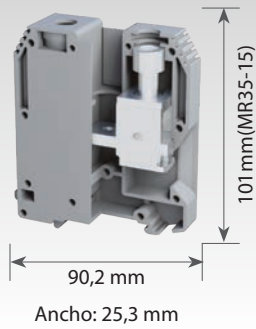

TBL 95

8000099108

5

1000 V / 232 A

750 V / 210 A

95

6 - 16

6 - 95

10 - 95

10-3/0 AWG

24.5

14

M8

8

3 / III / I

Product Name Nombre de producto	Order No. No. de orden	Qty. Qty.
DR 35-7,5 S 2M	8015393407	40
DR 35-15 S 2M	8015393427	20
SS 1	8010097308	50
SS 2	8010097318	50
PS 1	8010197328	50
SCC 95/2	8013095923	10
SCC 95/3	8013095933	10
MTG 10	8020385009	250
GM1	8014393008	50
GM2	8014393018	50
6		

TBL 150

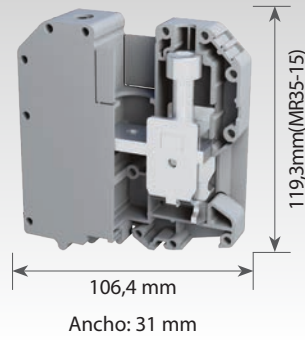

TBL 150

8000099118

5

1000 V / 309 A

150

6 - 16

6 - 150

10 - 150

10-300 kcmil

27

22

M10

8

3 / III / I

Product Name Nombre de producto	Order No. No. de orden	Qty. Qty.
DR 35-7,5 S 2M	8015393407	40
DR 35-15 S 2M	8015393427	20
SS 1	8010097308	50
SS 2	8010097318	50
PS 1	8010197328	50
SCC 150/2	8013094023	10
MTG 10	8020385009	250
GM1	8014393008	50
GM2	8014393018	50
8		

Screw Type Terminal Blocks Bornes de tipo tornillo

High Current Terminal Blocks Bornes de alta corriente



Product Name / Nombre de producto
Order No. / No. de orden.
Packing Qty / Pzs. por paquete.
Rated Values / Valores nominales
IEC 60947-7-1
IEC/EN 60079-7
Connection Information / Información de conexión
Cross-Section / Sección transversal (mm ²)
Hole Diameter & Power Rail (mm) / Diámetro del agujero & Riel de potencia (mm)
Cable Lugs DIN 46234 (min-max) (mm²) / Terminales tipo ojo DIN 46234 (min-max) (mm ²)
Cable Lugs DIN 46235 (min-max) (mm²) / Terminales tipo ojo DIN 46235 (min-max) (mm ²)
AWG DIN 46234 / AWG
AWG DIN 46235 / AWG
Descriptions / Descripción
Tightening Torque (N.m) / Torque de fijación
Screw Diameter / Diámetro del tornillo
Rated Impulse Voltage / Voltaje de impulso nominal (Kv)
Pollution D./ Voltage CAT/ Material Group / Grado de contaminación / Voltaje (CAT) / Grupo de material
Accessories / Accesorios
Din Rail / Riel DIN
Isolation Cover / Cubierta de aislamiento
End Stopper / Tope final
Marking Tags / Etiquetas de marcado
Group Label / Etiqueta de grupo

TBB 70

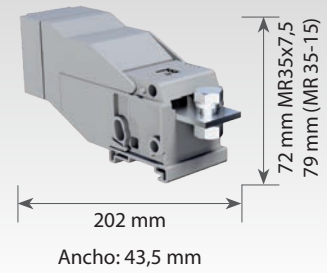

TBB 70		
8000099128		
5		
1000 V / 192 A		
70		
9/25x3		
2,5 - 70		
16 - 70		
14-2/0		
6-2/0		
15-20		
M8		
8		
3 / III / I		
Product Name Nombre de producto	Order No. No. de orden	Qty. Qty.
DR 35-7,5 S 2M	8015393407	40
DR 35-15 S 2M	8015393427	20
C-TBB 70-95-150	8012396608	8
SS 1	8010097308	50
SS 2	8010097318	50
PS 1	8010197328	50
MTG 5	8020389009	500
GM1	8014393008	50
GM2	8014393018	50

TBB 95

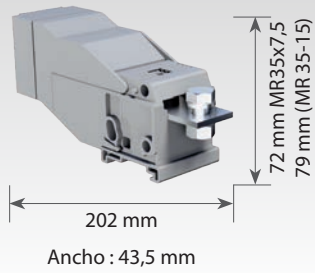

TBB 95

8000099138

5

1000 V / 232 A

95

11/25x5

6 - 95

16 - 95

10-3/0

6-3/0

25-30

M10

8

3 / III / I

Product Name Nombre de producto	Order No. No. de orden	Qty. Qty.
DR 35-7,5 S 2M	8015393407	40
DR 35-15 S 2M	8015393427	20
C-TBB 70-95-150	8012396608	8
SS 1	8010097308	50
SS 2	8010097318	50
PS 1	8010197328	50
MTG 5	8020389009	500
GM1	8014393008	50
GM2	8014393018	50

TBB 150

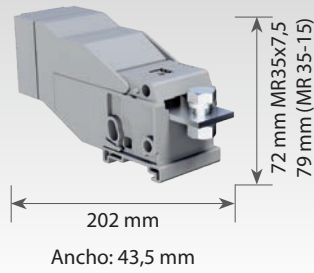

TBB 150

8000099148

5

1000 V / 309 A

150

13/30x5

10 - 150

25 - 150

8-300 Kcmil

4-300 Kcmil

25-30

M12

8

3 / III / I

Product Name Nombre de producto	Order No. No. de orden	Qty. Qty.
DR 35-7,5 S 2M	8015393407	40
DR 35-15 S 2M	8015393427	20
C-TBB 70-95-150	8012396608	8
SS 1	8010097308	50
SS 2	8010097318	50
PS 1	8010197328	50
MTG 5	8020389009	500
GM1	8014393008	50
GM2	8014393018	50

TBB 240

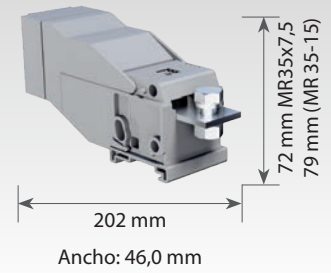

TBB 240

8000099158

4

1000 V / 415 A

240

17/29,7x9,7

25 - 240

50 - 185

4-500 Kcmil

0-350 Kcmil

30-35

M16

8

3 / III / I

Product Name Nombre de producto	Order No. No. de orden	Qty. Qty.
DR 35-7,5 S 2M	8015393407	40
DR 35-15 S 2M	8015393427	20
C-TBB 240	8012396618	10
SS 1	8010097308	50
SS 2	8010097318	50
PS 1	8010197328	50
MTG 5	8020389009	500
GM1	8014393008	50
GM2	8014393018	50

Screw Type Terminal Blocks Bornes de tipo tornillo

Earth Terminal Blocks Bornes de puesta a tierra



Product Name / Nombre de producto
Order No. / No. de orden.
Packing Qty / Pzs. por paquete.
Rated Values / Valores nominales
IEC 60947-7-1
IEC/EN 60079-7
Connection Information / Información de conexión
Cross-Section / Sección transversal (mm ²)
Solid Conductor Cross-section min / Sección transversal conductor sólido mín (mm ²)-(mín-máx)
Stranded Conductor Cross-Section / Sección transversal conductor trenzado (mm ²)-(mín-máx)
Flexible Conductor Cross-Section / Sección transversal conductor flexible (mm ²)-(mín-máx)
AWG
Descriptions / Descripción
Insulation Stripping Length / Longitud de pelado del aislante (mm)
Tightening Torque (N.m) / Torque de fijación
Screw Diameter / Diámetro del tornillo
Rated Impulse Voltage / Voltaje de impulso nominal (Kv)
Pollution D./ Voltage CAT/ Material Group / Grado de contaminación / Voltaje (CAT) / Grupo de material
Accessories / Accesorios
Din Rail / Riel DIN
End Stopper / Tope final
End Plate / Tapa final
Marking Tags / Etiquetas de marcado
Group Label / Etiqueta de grupo
Screwdriver / Perillero

NTT 2,5 E

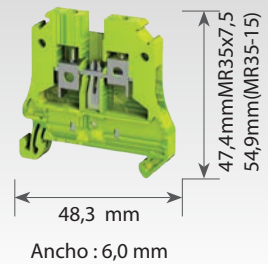

NTT 2,5 E		
8001099214		
50		
2,5		
0,5 - 4		
0,5 - 4		
0,5 - 2,5		
20-12 AWG		
10		
0,6		
M2,5		
6		
3 / III / I		
Product Name Nombre de producto	Order No. No. de orden	Qty. Qty.
DR 35-7,5 S 2M	8015393407	40
DR 35-15 S 2M	8015393427	20
PS 1	8010197328	50
EPL TBL 2,5-10	8012396118	50
MTG 6	8020388009	500
GM1	8014393008	50
GM2	8014393018	50
0,5x3,0		

NTT 4 E

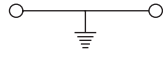
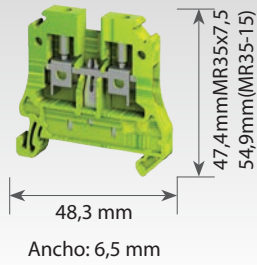

NTT 4 E

8001099224

50

4

0,5 - 4

0,5 - 4

0,5 - 4

20-12 AWG

12

0,8

M3

6

3 / III / I

Product Name Nombre de producto	Order No. No. de orden	Qty. Qty.
DR 35-7,5 S 2M	8015393407	40
DR 35-15 S 2M	8015393427	20
PS 1	8010197328	50
EPL TBL 2,5-10	8012396118	50
MTG 6,4	8020387009	500
GM1	8014393008	50
GM2	8014393018	50
0,5x3,0		

NTT 6 E

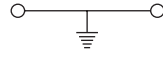
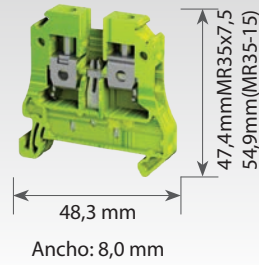

NTT 6 E

8001099234

25

6

0,5 - 10

0,5 - 10

0,5 - 6

20-8 AWG

12

1,2

M4

8

3 / III / I

Product Name Nombre de producto	Order No. No. de orden	Qty. Qty.
DR 35-7,5 S 2M	8015393407	40
DR 35-15 S 2M	8015393427	20
PS 1	8010197328	50
EPL TBL 2,5-10	8012396118	50
MTG 8	8020386009	500
GM1	8014393008	50
GM2	8014393018	50
1,0x5,5		

NTT 10 E

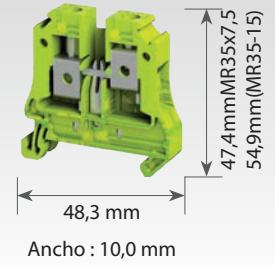

NTT 10 E

8001099244

20

10

0,5 - 16

0,5 - 16

0,5 - 10

20-6 AWG

12

1,5

M6

8

3 / III / I

Product Name Nombre de producto	Order No. No. de orden	Qty. Qty.
DR 35-7,5 S 2M	8015393407	40
DR 35-15 S 2M	8015393427	20
PS 1	8010197328	50
EPL TBL 2,5-10	8012396118	50
MTG 10	8020385009	250
GM1	8014393008	50
GM2	8014393018	50
1,0x5,5		

Screw Type Terminal Blocks Bornes de tipo tornillo

Earth Terminal Blocks Bornes de puesta a tierra



Product Name / Nombre de producto
Order No. / No. de orden.
Packing Qty / Pzs. por paquete.
Rated Values / Valores nominales
IEC 60947-7-1
IEC/EN 60079-7
Connection Information / Información de conexión
Cross-Section / Sección transversal (mm ²)
Solid Conductor Cross-section min / Sección transversal conductor sólido mín (mm ²)-(mín-máx)
Stranded Conductor Cross-Section / Sección transversal conductor trenzado (mm ²)-(mín-máx)
Flexible Conductor Cross-Section / Sección transversal conductor flexible (mm ²)-(mín-máx)
AWG
Descriptions / Descripción
Insulation Stripping Length / Longitud de pelado del aislante (mm)
Tightening Torque (N.m) / Torque de fijación
Screw Diameter / Diámetro del tornillo
Rated Impulse Voltage / Voltaje de impulso nominal (Kv)
Pollution D./ Voltage CAT/ Material Group / Grado de contaminación / Voltaje (CAT) / Grupo de material
Accessories / Accesorios
Din Rail / Riel DIN
End Stopper / Tope final
Partition Plate / Placa de partición
Marking Tags / Etiquetas de marcado
Screwdriver / Perillero

TBL 16 E



TBL 16 E		
8001099194		
20		
16		
0,5 - 16		
0,5 - 16		
0,5 - 16		
20-6 AWG		
12,3		
1,2		
M5		
8		
3 / III / I		
Product Name Nombre de producto	Order No. No. de orden	Qty. Qty.
DR 35-7,5 S 2M	8015393407	40
DR 35-15 S 2M	8015393427	20
SS 1	8010097308	50
SS 2	8010097318	50
PS 1	8010197328	50
GPR	8012396568	20
MTG 10	8020385009	250
1,0x5,5		

TBL 35 E

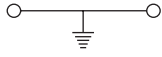
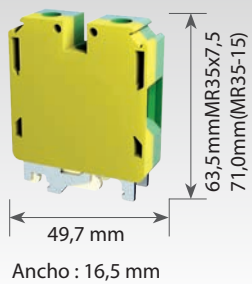

TBL 35 E

8001099204

20

35

1,5 - 35

1,5 - 35

1,5 - 35

16-2 AWG

14,9

3,5

M6

8

3 / III / I

Product Name Nombre de producto	Order No. No. de orden	Qty. Qty.
DR 35-7,5 S 2M	8015393407	40
DR 35-15 S 2M	8015393427	20
SS 1	8010097308	50
SS 2	8010097318	50
PS 1	8010197328	50
GPR	8012396568	20
MTG 10	8020385009	250
1,2x6,5		

Screw Type Terminal Blocks Bornes de tipo tornillo

Multilevel Terminal Blocks Bornes multinivel



Product Name / Nombre de producto
Order No. / No. de orden.
Packing Qty / Pzs. por paquete.
Rated Values / Valores nominales IEC 60947-7-1
Connection Information / Información de conexión
Cross-Section / Sección transversal (mm ²)
Solid Conductor Cross-section min / Sección transversal conductor sólido mín (mm ²)-(mín-máx)
Stranded Conductor Cross-Section / Sección transversal conductor trenzado (mm ²)-(mín-máx)
Flexible Conductor Cross-Section / Sección transversal conductor flexible (mm ²)-(mín-máx)
AWG
Descriptions / Descripción
Insulation Stripping Length / Longitud de pelado del aislante (mm)
Tightening Torque (N.m) / Torque de fijación
Screw Diameter / Diámetro del tornillo
Rated Impulse Voltage / Voltaje de impulso nominal (Kv)
Pollution D./ Voltage CAT/ Material Group / Grado de contaminación / Voltaje (CAT) / Grupo de material
Accessories / Accesorios
Din Rail / Riel DIN
End Stopper / Tope final
End Plate / Tapa final
Partition Plate / Placa de partición
Small Partition Plate / Placa de partición pequeña
Cross Connection / Puentes de conexión
Test Plug / Terminal de prueba
Marking Tags / Etiquetas de marcado
Group Label / Etiqueta de grupo
Screwdriver / Perillero

TBL 2,5-4 2P

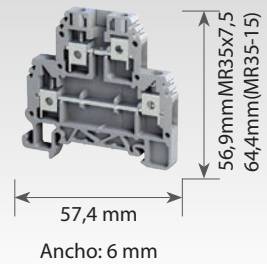

TBL 2,5-4 2P		
8002099438		
50		
500 V / 32 A		
2,5 - 4		
0,5 - 4		
0,5 - 4		
0,5 - 4		
20-12 AWG		
9		
0,4		
M2,5		
6		
3 / III / I		
Product Name Nombre de producto	Order No. No. de orden	Qty. Qty.
DR 35-7,5 S 2M	8015393407	40
DR 35-15 S 2M	8015393427	20
SS 1	8010097308	50
SS 2	8010097318	50
PS 1	8010197328	50
EPL TBL 2,5-4 2P	8012396208	20
PR TBL 4 2P	8012396508	20
SPR TBL 4 2P	8012396558	100
SCC 2,5/2	8013095023	50
SCC 2,5/3	8013095033	50
SCC 2,5/10	8013095003	10
TST 1	8014393227	50
MTG 6	8020388009	500
GM1	8014393008	50
GM2	8014393018	50
0,5x3,0		

TBL 4 2 P

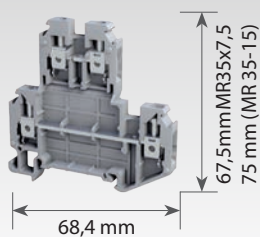

Ancho: 6,4 mm



TBL 4 2P

8002099258

50

500 V / 32 A

4

0,5 - 4

0,5 - 4

0,5 - 4

20-12 AWG

9

0,4

M2,5

6

3 / III / I

TBL 4 3 P

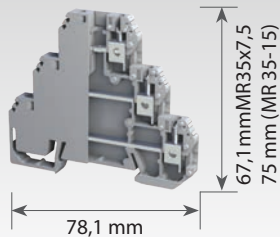

Ancho: 6,4 mm

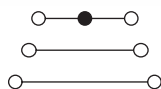

TBL 4 3P

8002099478

25

400 V / 32 A

4

0,5 - 4

0,5 - 4

0,5 - 4

20-12 AWG

9

0,4

M2,5

6

3 / III / I

TBL 2,5-4 2PK

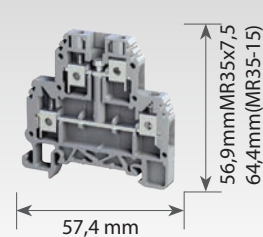

Ancho 6,0 mm

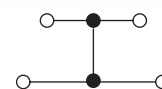

TBL 2,5-4 2PK

8002099448

50

500 V / 32 A

2,5 - 4

0,5 - 4

0,5 - 4

0,5 - 4

20-12 AWG

9

0,4

M2,5

6

3 / III / I

Product Name Nombre de producto	Order No. No. de orden	Qty. Qty.
DR 35-7,5 S 2M	8015393407	40
DR 35-15 S 2M	8015393427	20
SS 1	8010097308	50
SS 2	8010097318	50
PS 1	8010197328	50
EPL1 TBL 4 2P	8012396218	20
EPL2 TBL 4 2P	8012396228	20
EPL3 TBL 4 2P	8012396238	20
GPR	8012396568	20
SCC 4/2 TBL 4 2P	8013094123	50
SCC 4/3 TBL 4 2P	8013094133	50
SCC 4/10 TBL 4 2P	8013094103	10
TST 1	8014393227	50
MTG 6,4	8020387009	500
GM1	8014393008	50
GM2	8014393018	50
0,5x3,0		

Product Name Nombre de producto	Order No. No. de orden	Qty. Qty.
DR 35-7,5 S 2M	8015393407	40
DR 35-15 S 2M	8015393427	20
SS 1	8010097308	50
SS 2	8010097318	50
PS 1	8010197328	50
EPL1 TBL 4 2P	8012396218	20
EPL2 TBL 4 2P	8012396228	20
EPL3 TBL 4 2P	8012396238	20
GPR	8012396568	20
SCC 4/2 TBL 4 2P	8013094123	50
SCC 4/3 TBL 4 2P	8013094133	50
SCC 4/10 TBL 4 2P	8013094103	10
TST 1	8014393227	50
MTG 6,4	8020387009	500
GM1	8014393008	50
GM2	8014393018	50
0,5x3,0		

Product Name Nombre de producto	Order No. No. de orden	Qty. Qty.
DR 35-7,5 S 2M	8015393407	40
DR 35-15 S 2M	8015393427	20
SS 1	8010097308	50
SS 2	8010097318	50
PS 1	8010197328	50
EPL TBL 2,5-4 2P	8012396208	20
GPR	8012396568	20
SCC 4/2 TBL 4 2P	8013094123	50
SCC 4/3 TBL 4 2P	8013094133	50
SCC 4/10 TBL 4 2P	8013094103	10
TST 1	8014393227	50
MTG 6	8020388009	500
GM1	8014393008	50
GM2	8014393018	50
0,5x3,0		

Screw Type Terminal Blocks Bornes de tipo tornillo

Fuse and Disconnect Terminal Blocks Bornes para desconexión y portafusibles



Product Name / Nombre de producto
Order No. / No. de orden.
Packing Qty / Pzs. por paquete.
Rated Values / Valores nominales IEC 60947-7-3 (FDT 4) / IEC 60947-7-1 (TBL S)
Connection Information / Información de conexión
Cross-Section / Sección transversal (mm ²)
Solid Conductor Cross-section min / Sección transversal conductor sólido mín (mm ²)-(mín-máx)
Stranded Conductor Cross-Section / Sección transversal conductor trenzado (mm ²)-(mín-máx)
Flexible Conductor Cross-Section / Sección transversal conductor flexible (mm ²)-(mín-máx)
AWG
Descriptions / Descripción
Insulation Stripping Length / Longitud de pelado del aislante (mm)
Tightening Torque (N.m) / Torque de fijación
Screw Diameter / Diámetro del tornillo
Rated Impulse Voltage / Voltaje de impulso nominal (Kv)
Pollution D./ Voltage CAT/ Material Group / Grado de contaminación / Voltaje (CAT) / Grupo de material
Accessories / Accesorios
Din Rail / Riel DIN
End Stopper / Tope final
Comb Connector / Peine de conexión
Marking Tags / Etiquetas de marcado
Group Label / Etiqueta de grupo
Screwdriver / Perillero

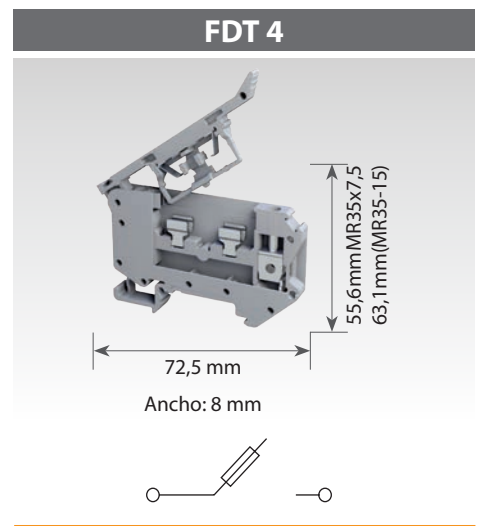

FDT 4
8003099488
25
800 V / 6,3 A
4
0,5 - 4
0,5 - 4
0,5 - 4
20-12 AWG
12
0,5
M3
8
3 / III / I

Product Name Nombre de producto	Order No. No. de orden	Qty. Qty.
DR 35-7,5 S 2M	8015393407	40
DR 35-15 S 2M	8015393427	20
SS 1	8010097308	50
SS 2	8010097318	50
PS 1	8010197328	50
TCC 6/2	8013394823	50
TCC 6/3	8013394833	50
TCC 6/10	8013394803	50
MTG 8	8020386009	500
GM1	8014393008	50
GM2	8014393018	50
0,5x3,0		

TBL 2,5 S

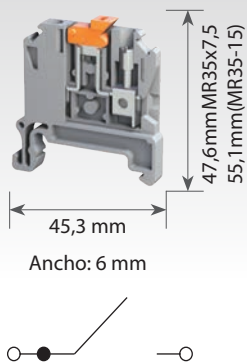

TBL 2,5 S

8003099528

25

800 V / 17,5 A

2,5

0,5 - 4

0,5 - 4

0,5 - 4

20-12 AWG

9

0,4

M2,5

6

3 / III / I

Product Name Nombre de producto	Order No. No. de orden	Qty. Qty.
DR 35-7,5 S 2M	8015393407	40
DR 35-15 S 2M	8015393427	20
SS 1	8010097308	50
SS 2	8010097318	50
PS 1	8010197328	50
MTG 6	8020388009	500
GM1	8014393008	50
GM2	8014393018	50
0,5x3,0		

* Fuse and disconnect type terminal blocks are double side closed, no need for an extra end plate usage.

* Los bornes para desconexión y portafusibles poseen tapa de ambos lados, por lo que no se necesitan tapas finales adicionales.

Screw Type Terminal Blocks Bornes de tipo tornillo

Test and Disconnect Terminal Blocks Bornes de prueba y desconexión



Product Name / Nombre de producto
Order No. / No. de orden.
Packing Qty / Pzs. por paquete.
Rated Values / Valores nominales
IEC 60947-7-1
IEC/EN 60079-7
Connection Information / Información de conexión
Cross-Section / Sección transversal (mm ²)
Solid Conductor Cross-section min / Sección transversal conductor sólido mín (mm ²)-(mín-máx)
Stranded Conductor Cross-Section / Sección transversal conductor trenzado (mm ²)-(mín-máx)
Flexible Conductor Cross-Section / Sección transversal conductor flexible (mm ²)-(mín-máx)
AWG
Descriptions / Descripción
Insulation Stripping Length / Longitud de pelado del aislante (mm)
Tightening Torque (N.m) / Torque de fijación
Screw Diameter / Diámetro del tornillo
Rated Impulse Voltage / Voltaje de impulso nominal (Kv)
Pollution D./ Voltage CAT/ Material Group / Grado de contaminación / Voltaje (CAT) / Grupo de material
Center Screw / Tightening Torque (N.m) / Tornillo central / Torque de fijación
Accessories / Accesorios
Din Rail / Riel DIN
End Stopper / Tope final
End Plate Section / Tapa final
Swipe Connector / Conector deslizante
Comb Connector / Peine de conexión
Test Plug / Terminal de prueba
Marking Tags / Etiquetas de marcado
Group Label / Etiqueta de grupo
Screwdriver / Perillero

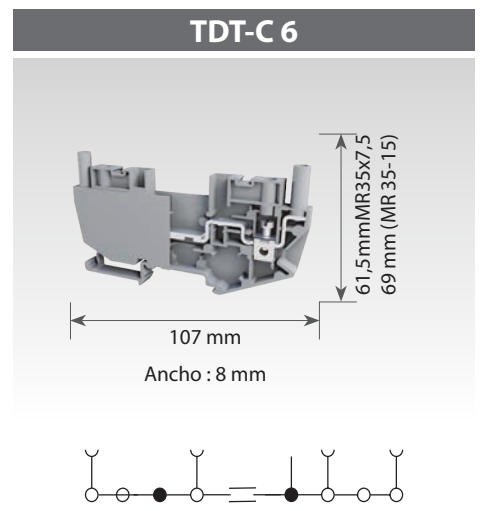

TDT-C 6
8004099808
20
400 V / 41 A
6
0,5 - 10
0,5 - 10
0,5 - 6
20-8 AWG
12
1,2
M3,5
6
3 / III / I
M3 / 0,5

Product Name Nombre de producto	Order No. No. de orden	Qty. Qty.
DR 35-7,5 S 2M	8015393407	40
DR 35-15 S 2M	8015393427	20
SS 1	8010097308	50
SS 2	8010097318	50
PS 1	8010197328	50
SLC 2	8013394923	50
SLC 3	8013394933	50
SLC 4	8013394943	50
TCC 6/2	8013394823	50
TCC 6/3	8013394833	50
TCC 6/10	8013394803	10
TST-I 1	8014393108	50
MTG 8	8020386009	500
GM1	8014393008	50
GM2	8014393018	50
0,5x3.0 / 0,6x3,5		

TDT-V 6

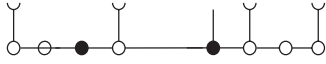
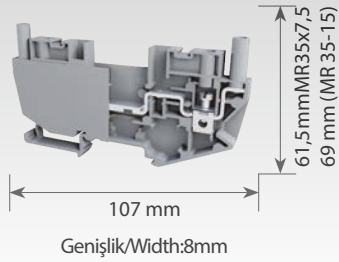

TDT-V 6

8004099818

20

400 V / 41 A

6

0,5 - 10

0,5 - 10

0,5 - 6

20-8 AWG

12

1,2

M3,5

6

3 / III / I

M3 / 0,5

Product Name Nombre de producto	Order No. No. de orden	Qty. Qty.
DR 35-7,5 S 2M	8015393407	40
DR 35-15 S 2M	8015393427	20
SS 1	8010097308	50
SS 2	8010097318	50
PS 1	8010197328	50
SLC 2	8013394923	50
SLC 3	8013394933	50
SLC 4	8013394943	50
TCC 6/2	8013394823	50
TCC 6/3	8013394833	50
TCC 6/10	8013394803	10
TST-I 1	8014393108	50
MTG 8	8020386009	500
GM1	8014393008	50
GM2	8014393018	50
0,6x3,5		

TDS-C 6

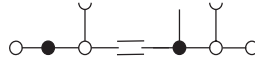
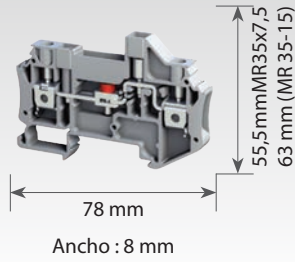

TDS-C 6

8004099828

25

400 V / 41 A

6

0,5 - 10

0,5 - 10

0,5 - 6

20-8 AWG

12

1,2

M3,5

6

3 / III / I

M3 / 0,5

Product Name Nombre de producto	Order No. No. de orden	Qty. Qty.
DR 35-7,5 S 2M	8015393407	40
DR 35-15 S 2M	8015393427	20
SS 1	8010097308	50
SS 2	8010097318	50
PS 1	8010197328	50
EPL TDS	8012396018	50
SLC 2	8013394923	50
SLC 3	8013394933	50
SLC 4	8013394943	50
TCC 6/2	8013394823	50
TCC 6/3	8013394833	50
TCC 6/10	8013394803	10
TST-I 1	8014393108	50
MTG 8	8020386009	500
GM1	8014393008	50
GM2	8014393018	50
0,5x3,0 / 0,6x3,5		

TDV-C 6

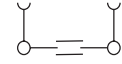
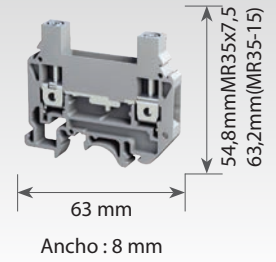

TDV-C 6

8004099838

25

500 V / 41 A

6

0,5 - 10

0,5 - 10

0,5 - 6

20-8 AWG

12

1,2

M3,5

6

3 / III / I

M3 / 0,5

Product Name Nombre de producto	Order No. No. de orden	Qty. Qty.
DR 35-7,5 S 2M	8015393407	40
DR 35-15 S 2M	8015393427	20
SS 1	8010097308	50
SS 2	8010097318	50
PS 1	8010197328	50
EPL TDV	8012396028	50
TCC 6/2	8013394823	50
TCC 6/3	8013394833	50
TCC 6/10	8013394803	10
TST-I 1	8014393108	50
MTG 5	8020389009	500
GM1	8014393008	50
GM2	8014393018	50
1,0x5,5		

Screw Type Terminal Blocks Bornes de tipo tornillo

Test and Disconnect Terminal Blocks Bornes de prueba y desconexión



Product Name / Nombre de producto
Order No. / No. de orden.
Packing Qty / Pzs. por paquete.
Rated Values / Valores nominales
IEC 60947-7-1
IEC/EN 60079-7
Connection Information / Información de conexión
Cross-Section / Sección transversal (mm ²)
Solid Conductor Cross-section min / Sección transversal conductor sólido mín (mm ²)-(mín-máx)
Stranded Conductor Cross-Section / Sección transversal conductor trenzado (mm ²)-(mín-máx)
Flexible Conductor Cross-Section / Sección transversal conductor flexible (mm ²)-(mín-máx)
AWG
Descriptions / Descripción
Insulation Stripping Length / Longitud de pelado del aislante (mm)
Tightening Torque (N.m) / Torque de fijación
Screw Diameter / Diámetro del tornillo
Rated Impulse Voltage / Voltaje de impulso nominal (Kv)
Pollution D./ Voltage CAT/ Material Group / Grado de contaminación / Voltaje (CAT) / Grupo de material
Center Screw / Tightening Torque (N.m) / Tornillo central / Torque de fijación
Accessories / Accesorios
Din Rail / Riel DIN
End Stopper / Tope final
End Plate Section / Tapa final
Swipe Connector / Conector deslizante
Comb Connector / Peine de conexión
Test Plug / Terminal de prueba
Marking Tags / Etiquetas de marcado
Group Label / Etiqueta de grupo
Screwdriver / Perillero

Color Codes / Código de colores								
800009900....	...0	...1	...2	...3	...4	...5	...6	...9

TDS-V 6

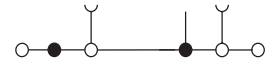
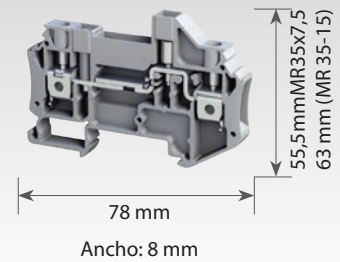

TDS-V 6
8004099848
25
400 V
41 A
6
0,5 - 10
0,5 - 10
0,5 - 6
20-8 AWG
12
1,2
M3,5
6
3 / III / I

Product Name Nombre de producto	Order No. No. de orden	Qty. Qty.
DR 35-7,5 S 2M	8015393407	40
DR 35-15 S 2M	8015393427	20
SS 1	8010097308	50
SS 2	8010097318	50
PS 1	8010197328	50
EPL TDS	8012396018	50
SLC-R 2	8014393307	50
SLC-R 3	8014393317	50
SLC-R 4	8014393327	50
TCC 6/2	8013394823	50
TCC 6/3	8013394833	50
TCC 6/10	8013394803	10
TST-I 1	8014393108	50
MTG 8	8020386009	500
GM1	8014393008	50
GM2	8014393018	50
0,6x3,5		

TDY-C 6

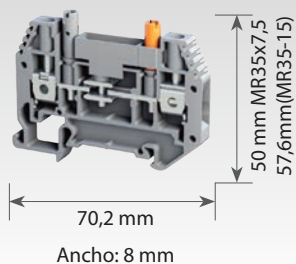

TDY-C 6

8004099858

25

400 V

41 A

6

0,5 - 10

0,5 - 10

0,5 - 6

20-8 AWG

12

0,5

M3,5

6

3 / III / I

M3 / 0,5

Product Name Nombre de producto	Order No. No. de orden	Qty. Qty.
DR 35-7,5 S 2M	8015393407	40
DR 35-15 S 2M	8015393427	20
SS 1	8010097308	50
SS 2	8010097318	50
PS 1	8010197328	50
EPL TDY	8012396038	50
SLC-R 2	8014393307	50
SLC-R 3	8014393317	50
SLC-R 4	8014393327	50
TCC 6/2	8013394823	50
TCC 6/3	8013394833	50
TCC 6/10	8013394803	10
TST-I 1	8014393108	50
MTG 8	8020386009	500
GM1	8014393008	50
GM2	8014393018	50
0,6x3,5 / 0,5x3.0		

Push-in Terminal Blocks Bornes tipo Push-in

Feed Through Terminal Blocks Bornes de paso



Product Name / Nombre de producto
Order No. / No. de orden.
Packing Qty / Pzs. por paquete.
Rated Values / Valores nominales IEC 60947-7-1
Connection Information / Información de conexión
Cross-Section / Sección transversal (mm ²)
Solid Conductor Cross-section min / Sección transversal conductor sólido mín (mm ²)-(mín-máx)
Stranded Conductor Cross-Section / Sección transversal conductor trenzado (mm ²)-(mín-máx)
Flexible Conductor Cross-Section / Sección transversal conductor flexible (mm ²)-(mín-máx)
AWG
Descriptions / Descripción
Insulation Stripping Length / Longitud de pelado del aislante (mm)
Tightening Torque (N.m) / Torque de fijación
Screw Diameter / Diámetro del tornillo
Rated Impulse Voltage / Voltaje de impulso nominal (Kv)
Pollution D./ Voltage CAT/ Material Group / Grado de contaminación / Voltaje (CAT) / Grupo de material
Accessories / Accesorios
Din Rail / Riel DIN
End Stopper / Tope final
Cross Connection / Puentes de conexión
Marking Tags / Etiquetas de marcado
Strip Label / Etiqueta de tira
Group Label / Etiqueta de grupo

PFT 2,5

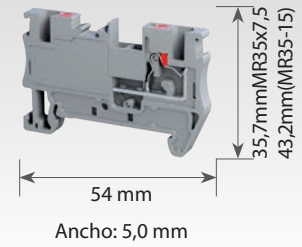

PFT 2,5		
8000298008		
100		
800 V / 24 A		
2,5		
0,5 - 2,5		
0,5 - 2,5		
0,5 - 2,5		
20-12 AWG		
12		
8		
3 / III / I		
Product Name Nombre de producto	Order No. No. de orden	Qty. Qty.
DR 35-7,5 S 2M	8015393407	40
DR 35-15 S 2M	8015393427	20
PS 1	8010197328	50
PCC 2,5/2	8013294523	100
PCC 2,5/3	8013294533	100
PCC 2,5/10	8013294503	10
MTG 5	8020389009	500
TBSL 22X20	8020384009	1
GM1	8014393008	50
GM2	8014393018	50

Color codes / Código de colores										
800009900....	...0	...1	...2	...3	...4	...5	...6	...7	...8	...9

PFT 4

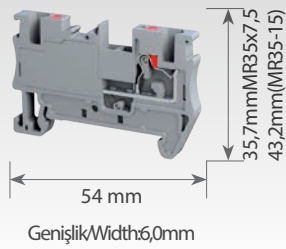

PFT 4

8000298018

100

800 V / 32 A

4

0,5 - 4

0,5 - 4

0,5 - 4

20-10 AWG

12

8

3 / III / I

PFT 6

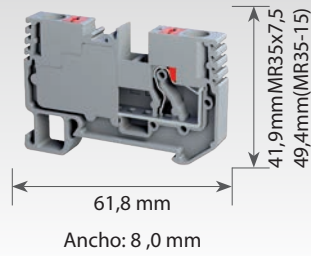

PFT 6

8000298028

50

1000 V / 41 A

6

0,5 - 6

0,5 - 6

0,5 - 6

20-8 AWG

12

8

3 / III / I

PFT 10

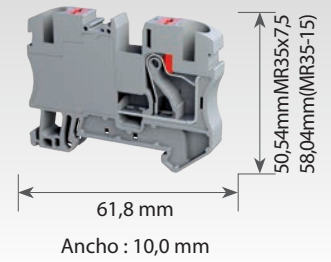

PFT 10

8000298038

30

1000 V / 57 A

10

0,5 - 16

0,5 - 10

0,5 - 10

20-6 AWG

18

8

3 / III / I

Product Name	Order No.	Qty.
Nombre de producto	No. de orden	Qty.
DR 35-7,5 S 2M	8015393407	40
DR 35-15 S 2M	8015393427	20
PS 1	8010197328	50
PCC 4/2	8013294623	100
PCC 4/3	8013294633	100
PCC 4/10	8013294603	10
MTG 6	8020388009	500
TBSL 22X20	8020384009	1
GM1	8014393008	50
GM2	8014393018	50

Product Name	Order No.	Qty.
Nombre de producto	No. de orden	Qty.
DR 35-7,5 S 2M	8015393407	40
DR 35-15 S 2M	8015393427	20
PS 1	8010197328	50
PCC 6/2	8013294723	50
PCC 6/3	8013294733	50
PCC 6/10	8013294703	10
MTG 8	8020386009	500
TBSL 22X20	8020384009	1
GM1	8014393008	50
GM2	8014393018	50

Product Name	Order No.	Qty.
Nombre de producto	No. de orden	Qty.
DR 35-7,5 S 2M	8015393407	40
DR 35-15 S 2M	8015393427	20
PS 1	8010197328	50
PCC 10/2	8013294823	10
PCC 10/3	8013294833	10
MTG 10	8020385009	250
TBSL 22X20	8020384009	1
GM1	8014393008	50
GM2	8014393018	50

Push-in Terminal Blocks Bornes tipo Push-in

Earth Terminal Blocks Bornes de puesta a tierra



Product Name / Nombre de producto
Order No. / No. de orden.
Packing Qty / Pzs. por paquete.
Rated Values / Valores nominales IEC 60947-7-2
Connection Information / Información de conexión
Cross-Section / Sección transversal (mm ²)
Solid Conductor Cross-section min / Sección transversal conductor sólido mín (mm ²)-(mín-máx)
Stranded Conductor Cross-Section / Sección transversal conductor trenzado (mm ²)-(mín-máx)
Flexible Conductor Cross-Section / Sección transversal conductor flexible (mm ²)-(mín-máx)
AWG
Descriptions / Descripción
Insulation Stripping Length / Longitud de pelado del aislante (mm)
Tightening Torque (N.m) / Torque de fijación
Screw Diameter / Diámetro del tornillo
Rated Impulse Voltage / Voltaje de impulso nominal (Kv)
Pollution D./ Voltage CAT/ Material Group / Grado de contaminación / Voltaje (CAT) / Grupo de material
Accessories / Accesorios
Din Rail / Riel DIN
End Stopper / Tope final
Marking Tags / Etiquetas de marcado
Strip Label / Etiqueta de tira
Group Label / Etiqueta de grupo

PFT 2,5 E

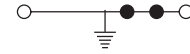
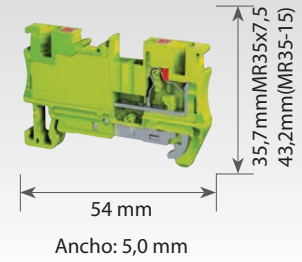

PFT 2,5 E		
8001298064		
50		
2,5		
0,5 - 2,5		
0,5 - 2,5		
0,5 - 2,5		
20-12 AWG		
12		
8		
3 / III / I		
Product Name Nombre de producto	Order No. No. de orden	Qty. Qty.
DR 35-7,5 S 2M	8015393407	40
DR 35-15 S 2M	8015393427	20
PS 1	8010197328	50
MTG 5	8020389009	500
TBSL 22X20	8020384009	1
GM1	8014393008	50
GM2	8014393018	50

PFT 4 E

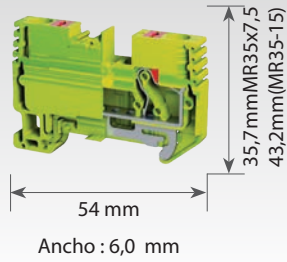

PFT 4 E

8001298074

50

4

0,5 - 4

0,5 - 4

0,5 - 4

20-10 AWG

12

8

3 / III / I

Product Name	Order No.	Qty.
Nombre de producto	No. de orden	Qty.
DR 35-7,5 S 2M	8015393407	40
DR 35-15 S 2M	8015393427	20
PS 1	8010197328	50
MTG 6	8020389009	500
TBSL 22X20	8020384009	1
GM1	8014393008	50
GM2	8014393018	50

PFT 6 E

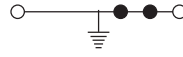
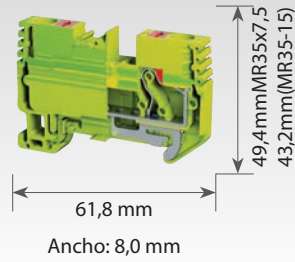

PFT 6 E

8001298084

25

6

0,5 - 6

0,5 - 6

0,5 - 6

20-8 AWG

12

8

3 / III / I

Product Name	Order No.	Qty.
Nombre de producto	No. de orden	Qty.
DR 35-7,5 S 2M	8015393407	40
DR 35-15 S 2M	8015393427	20
PS 1	8010197328	50
MTG 8	8020389009	500
TBSL 22X20	8020384009	1
GM1	8014393008	50
GM2	8014393018	50

PFT 10 E

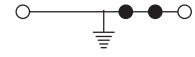
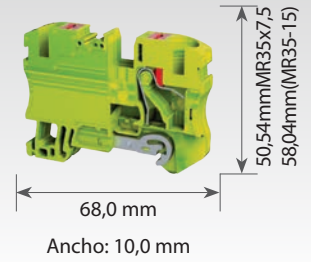

PFT 10 E

8001298104

30

10

0,5 - 16

0,5 - 10

0,5 - 10

20-6 AWG

18

8

3 / III / I

Product Name	Order No.	Qty.
Nombre de producto	No. de orden	Qty.
DR 35-7,5 S 2M	8015393407	40
DR 35-15 S 2M	8015393427	20
PS 1	8010197328	50
MTG 10	8020385009	250
TBSL 22X20	8020384009	1
GM1	8014393008	50
GM2	8014393018	50

Push-in Terminal Blocks Bornes tipo Push-in

Multi - Entry and Multi - Level Terminal Blocks Bornes multinivel y con múltiples entradas



Product Name / Nombre de producto
Order No. / No. de orden.
Packing Qty / Pzs. por paquete.
Rated Values / Valores nominales IEC 60947-7-1 / IEC 60947-7-2 (PFT 2,5 2P+E) IEC/EN 60079-7
Connection Information / Información de conexión
Cross-Section / Sección transversal (mm ²)
Solid Conductor Cross-section min / Sección transversal conductor sólido mín (mm ²)-(mín-máx)
Stranded Conductor Cross-Section / Sección transversal conductor trenzado (mm ²)-(mín-máx)
Flexible Conductor Cross-Section / Sección transversal conductor flexible (mm ²)-(mín-máx)
AWG
Descriptions / Descripción
Insulation Stripping Length / Longitud de pelado del aislante (mm)
Tightening Torque (N.m) / Torque de fijación
Screw Diameter / Diámetro del tornillo
Rated Impulse Voltage / Voltaje de impulso nominal (Kv)
Pollution D./ Voltage CAT/ Material Group / Grado de contaminación / Voltaje (CAT) / Grupo de material
Accessories / Accesorios
Din Rail / Riel DIN
End Stopper / Tope final
Cross Connection / Puentes de conexión
Marking Tags / Etiquetas de marcado
Strip Label / Etiqueta de tira
Group Label / Etiqueta de grupo

PFT 2,5 1X2

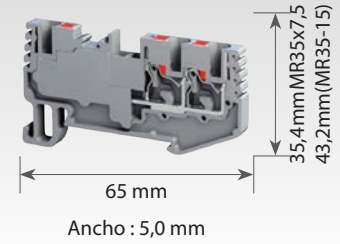

PFT 2,5 1X2		
8000298068		
40		
800 V / 24 A		
2,5		
0,5 - 2,5		
0,5 - 2,5		
0,5 - 2,5		
20-12 AWG		
12		
8		
3 / III / I		
Product Name Nombre de producto	Order No. No. de orden	Qty. Qty.
DR 35-7,5 S 2M	8015393407	40
DR 35-15 S 2M	8015393427	20
PS 1	8010197328	50
PCC 2,5/2	8013294523	100
PCC 2,5/3	8013294533	100
PCC 2,5/10	8013294503	10
MTG 5	8020389009	500
TBSL 22X20	8020384009	1
GM1	8014393008	50
GM2	8014393018	50

Color codes / Código de colores								
800009900....	...0	...1	...2	...3	...4	...5	...6	...9

PFT 2,5 2X2

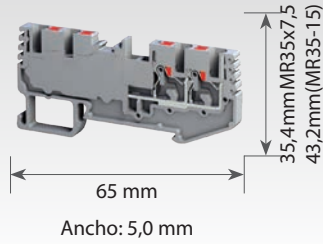

PFT 2,5 2X2

8000298078

40

800 V / 24 A

2,5

0,5 - 2,5

0,5 - 2,5

0,5 - 2,5

20-12 AWG

12

8

3 / III / I

Product Name Nombre de producto	Order No. No. de orden	Qty. Qty.
DR 35-7,5 S 2M	8015393407	40
DR 35-15 S 2M	8015393427	20
PS 1	8010197328	50
PCC 2,5/2	8013294523	100
PCC 2,5/3	8013294533	100
PCC 2,5/10	8013294503	10
MTG 5	8020389009	500
TBSL 22X20	8020384009	1
GM1	8014393008	50
GM2	8014393018	50

PFT 2,5 2P+E

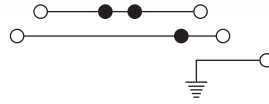
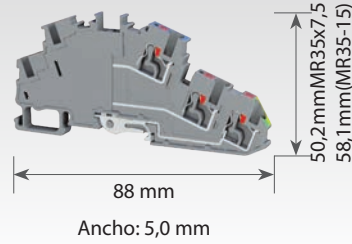

PFT 2,5 2P+E

8002298108

30

500 V / 24 A

2,5

0,5 - 2,5

0,5 - 2,5

0,5 - 2,5

20-12 AWG

12

8

3 / III / I

Product Name Nombre de producto	Order No. No. de orden	Qty. Qty.
DR 35-7,5 S 2M	8015393407	40
DR 35-15 S 2M	8015393427	20
PS 1	8010197328	50
PCC 2,5/2	8013294523	100
PCC 2,5/3	8013294533	100
PCC 2,5/10	8013294503	10
MTG 5	8020389009	500
TBSL 22X20	8020384009	1
GM1	8014393008	50
GM2	8014393018	50

PFT 2,5 2P

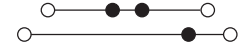
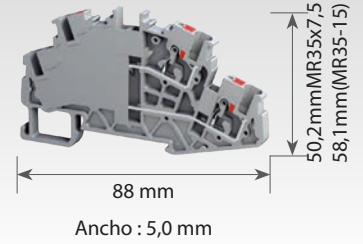

PFT 2,5 2P

8002298098

50

500 V / 24 A

2,5

0,5 - 2,5

0,5 - 2,5

0,5 - 2,5

20-12 AWG

12

8

3 / III / I

Product Name Nombre de producto	Order No. No. de orden	Qty. Qty.
DR 35-7,5 S 2M	8015393407	40
DR 35-15 S 2M	8015393427	20
PS 1	8010197328	50
PCC 2,5/2	8013294523	100
PCC 2,5/3	8013294533	100
PCC 2,5/10	8013294503	10
MTG 5	8020389009	500
TBSL 22X20	8020384009	1
GM1	8014393008	50
GM2	8014393018	50

Terminal Strips

Tiras de bornes

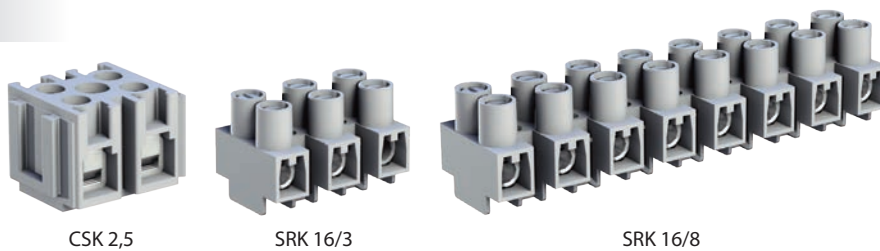

CSK 2,5

SRK 16/3

SRK 16/8



Product Name Nombre de producto	Order No. No. de orden	Voltage (V) Voltaje (V)	Current (A) Corriente (A)	Cross Section (mm ²) Sec. transversal (mm ²)	Number of Poles Número de polos	Clamping Screw Tornillo de fijación	Torque (Nm) Torque (Nm)	Packing Qty. Pzs. por paquete
SRK 16/2	8006097008	400	24	2,5	2	M 5	2	96
SRK 16/3	8006097018	400	24	2,5	3	M 5	2	32
SRK 16/4	8006097028	400	24	2,5	4	M 5	2	48
SRK 16/5	8006097038	400	24	2,5	5	M 5	2	32
SRK 16/6	8006097048	400	24	2,5	6	M 5	2	30
SRK 16/8	8006097058	400	24	2,5	8	M 5	2	24
SRK 16/10	8006097068	400	24	2,5	10	M 5	2	16
SRK 16/12	8006097078	400	24	2,5	12	M 5	2	8
CSK 2,5	8006097108	500	24	2,5	2	M 2,5	0,4 - 0,6	100
CSK 6	8006097118	800	41	6	2	M 3,5	0,8 - 1,2	60

End Bracket

Tope final

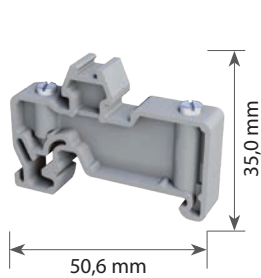

Ancho : 9,5 mm

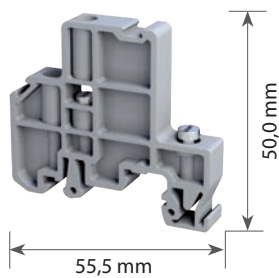

Ancho : 10,0 mm

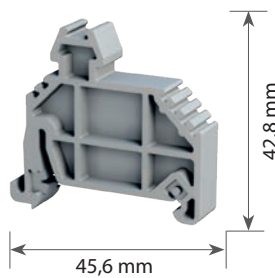

Ancho : 10,0 mm

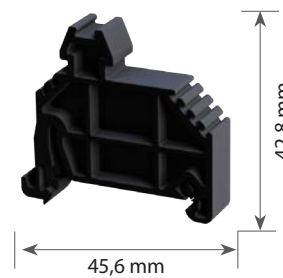

Ancho : 10,0 mm

Product Name Nombre de producto	SS 1
Order No. No. de orden	8010097308
Fixing Fijación	Screw type Tipo tornillo
Color Color	Gray Gris
Rail Riel	MR 35
Marker Marcador	MTG 5
Packing Qty. Pzs/paquete	50

Product Name Nombre de producto	SS 2
Order No. No. de orden	8010097318
Fixing Fijación	Screw type Tipo tornillo
Color Color	Gray Gris
Rail Riel	MR 35 MR 32
Marker Marcador	MTG 5
Packing Qty. Pzs/paquete	50

Product Name Nombre de producto	PS 1
Order No. No. de orden	8010197328
Fixing Fijación	Push in Push in
Color Color	Gray Gris
Rail Riel	MR 35
Marker Marcador	MTG 5
Packing Qty. Pzs/paquete	50

Product Name Nombre de producto	PS 1
Order No. No. de orden	8010197320
Fixing Fijación	Push in Push in
Color Color	Black Negro
Rail Riel	MR 35
Marker Marcador	MTG 5
Packing Qty. Pzs/paquete	50

Group Marker

Marcador de grupo

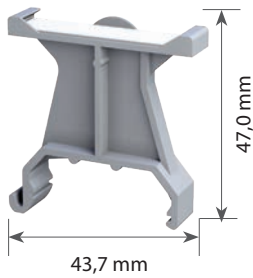

Ancho: 9,5 mm

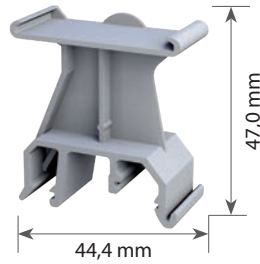

Ancho: 19,5 mm

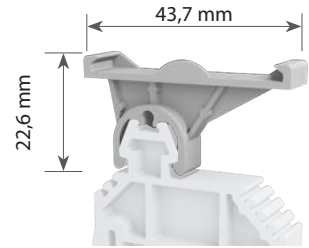

Ancho: 9,5 mm

Product Name Nombre de producto	GM 1
Order No. No. de orden	8014393008
Color Color	Gray / Gris
Rail Riel	MR 35
Packing Qty. Pzs/paquete	50

Product Name Nombre de producto	GM 2
Order No. No. de orden	8014393018
Color Color	Gray / Gris
Rail Riel	MR 32 - MR 35
Packing Qty. Pzs/paquete	50

Product Name Nombre de producto	SL 1
Order No. No. de orden	8012396008
Color Color	Gray / Gris
Packing Qty. Pzs/paquete	50

Marker Holder

Soporte para marcador

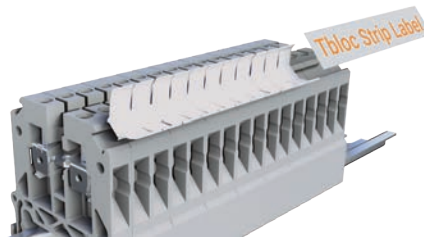

Product Name Nombre de producto	LHO
Order No. No. de orden	8020390009
Marker Marcador	TBSL 22x20
Packing Qty. Pzs/paquete	10

End Plates

Tapas finales



Product Name Nombre de producto	EPL TBL 2,5-10	EPL TBL 2,5-4 2P	EPL1 TBL 4 2P	EPL2 TBL 4 2P	EPL3 TBL 4 2P
Order No. No. de orden	8012396118	8012396208	8012396218	8012396228	8012396238
Color Color	Gray / Gris	Gray / Gris	Gray / Gris	Gray / Gris	Gray / Gris
Used with Usado con	TBL 2,5, TBL 4, TBL 6 TBL 10	TBL 2,4-4 2P	TBL 4 2P	TBL 4 2P	TBL 4 2P
Packing Qty. Pzs/paquete	50	20	20	20	20

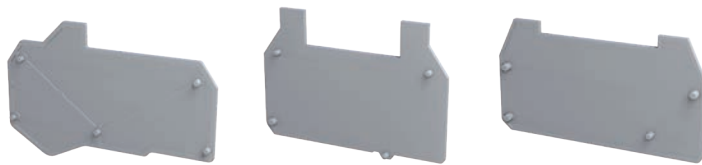

Product Name Nombre de producto	EPL TDS	EPL TDV	EPL TDY
Order No. No. de orden	8012396018	8012396028	8012396038
Color Color	Gray / Gris	Gray / Gris	Gray / Gris
Used with Usado con	TDS - C 6, TDS - V 6	TDV - C 6, TDS - V 6	TDY - C 6, TDY - C 6-1
Packing Qty. Pzs/paquete	50	50	50

Isolation Covers

Cubiertas de aislamiento



Product Name Nombre de producto	C-TBB 70-95-150	C-TBB 240
Order No. No. de orden	8012396608	8012396618
Color Color	Gray / Gris	Gray / Gris
Used with Usado con	TBB 70-95-150	TBB 240
Packing Qty. Pzs/paquete	8	10



Product Name Nombre de producto	PRTBL 2,5-10	PRTBL 4 2P	SPR 2,5-10
Order No. No. de orden	8012396408	8012396508	8012396528
Color	8012396406		
Used with Usado con	Gray / Gris	Gray / Gris	Gray / Gris
Packing Qty. Pzs/paquete	TBL 4, TBL 6, TBL 10	TBL 4 2P	TBL 2,5, TBL 4, TBL 6, TBL 10
Paket Adeti Packing Qty.	50	20	100

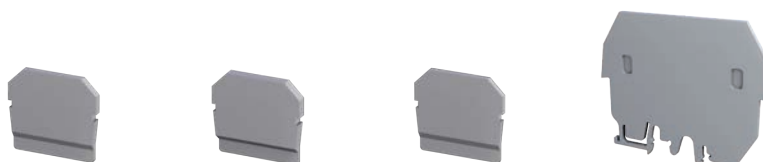

Product Name Nombre de producto	SPR 16-35	SPR 50	SPR TBL 4 2P	GPR
Order No. No. de orden	8012396538	8012396548	8012396558	8012396568
Color				8012396566
Used with Usado con	Gray / Gris	Gray / Gris	Gray / Gris	Gray / Gris
Packing Qty. Pzs/paquete	TBL 16, TBL 35	TBL 50	TBL 4 2P	TBL 16, TBL 35, TBL 50
Paket Adeti Packing Qty.	50	50	100	20

Test Sockets

Terminales de prueba



Order No. No. de orden	Product Name Nombre de producto	Used in Terminal Usado en borne	Color Color	Pack. Qty. Pzs.
8014393106	TST-I 1	TBL 6, TBL 10, TDT-C, TDT-V, TDS-C, TDS-V	Blue / Azul	50
8014393104	TST-I 1	TBL 6, TBL 10, TDT-C, TDT-V, TDS-C, TDS-V	Yellow / Amarillo	50
8014393108	TST-I 1	TBL 6, TBL 10, TDT-C, TDT-V, TDS-C, TDS-V	Gray / Gris	50
8014393102	TST-I 1	TBL 6, TBL 10, TDT-C, TDT-V, TDS-C, TDS-V	Red / Rojo	50
8014393100	TST-I 1	TBL 6, TBL 10, TDT-C, TDT-V, TDS-C, TDS-V	Black / Negro	50
8014393227	TST 1	TBL 2,5, TBL 4, TBL 2,5-4 2P, TBL 4 2P, TBL 2,5 3P		50
8014393237	TST 2	TBL 10		50
8014393247	TST 3	TBL 16		50
8014393257	TST 4	TBL 25, TBL 35		50

Comb Connector

Peine de conexión



Order No. No. de orden	Product Name Nombre de producto	Used in Terminal Usado en borne	Pole Polos	Cross Section (mm ²) Sección transversal (mm ²)	Color Color	Pack. Qty. Pzs
8013094323	TCC 4/2	TBL 4	2	4	Red / Rojo	50
8013094333	TCC 4/3	TBL 4	3	4	Red / Rojo	50
8013094303	TCC 4/10	TBL 4	10	4	Red / Rojo	10

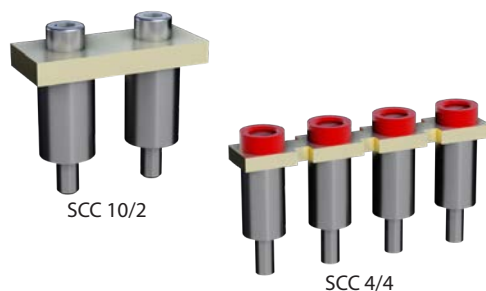

Order No. No. de orden	Product Name Nombre de producto	Used in Terminal Usado en borne	Pole Polos	Cross Section (mm ²) Sección transversal (mm ²)	Pack. Qty. Pzs
8013095023	SCC 2,5/2	TBL 2,5, TBL 2,5-4 2P	2	2,5	50
8013095033	SCC 2,5/3	TBL 2,5, TBL 2,5-4 2P	3	2,5	50
8013095003	SCC 2,5/10	TBL 2,5, TBL 2,5-4 2P	10	2,5	10
8013095123	SCC 4/2	TBL 4, TBL 4 2P	2	4	50
8013095133	SCC 4/3	TBL 4, TBL 4 2P	3	4	50
8013095103	SCC 4/10	TBL 4, TBL 4 2P	10	4	10
8013095223	SCC 6/2	TBL 6	2	6	50
8013095233	SCC 6/3	TBL 6	3	6	50
8013095203	SCC 6/10	TBL 6	10	6	10
8013095323	SCC 10/2	TBL 10	2	6	50
8013095333	SCC 10/3	TBL 10	3	10	50
8013095303	SCC 10/10	TBL 10	10	10	10
8013095423	SCC 16/2	TBL 16	2	10	20
8013095433	SCC 16/3	TBL 16	3	16	20
8013095403	SCC 16/10	TBL 16	10	16	10
8013095523	SCC 25/2	TBL 25	2	16	20
8013095533	SCC 25/3	TBL 25	3	25	20
8013095503	SCC 25/10	TBL 25	10	25	10
8013095623	SCC 35/2	TBL 35	2	25	20
8013095633	SCC 35/3	TBL 35	3	35	20
8013095603	SCC 35/10	TBL 35	10	35	10
8013095723	SCC 50/2	TBL 50	2	50	10
8013095733	SCC 50/3	TBL 50	3	50	10
8013095823	SCC 70/2	TBL 70	2	70	10
8013095833	SCC 70/3	TBL 70	3	70	10
8013095923	SCC 95/2	TBL 95	2	95	10
8013095933	SCC 95/3	TBL 95	3	95	10
8013094023	SCC 150/2	TBL 150	2	150	10
8013094123	SCC 4/2 TBL 4 2P	TBL 4 2P	2	4	50
8013094133	SCC 4/3 TBL 4 2P	TBL 4 2P	3	4	50
8013094163	SCC 4/6 TBL 4 2P	TBL 4 2P	6	4	20
8013094103	SCC 4/10 TBL 4 2P	TBL 4 2P	10	4	10

Push-in Cross Connections

Puentes de conexión tipo Push-in

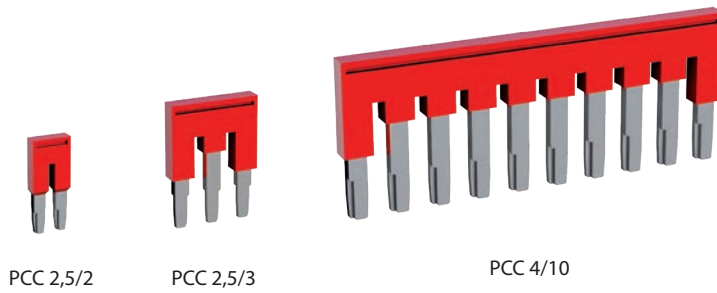

Order No. No. de orden	Product Name Nombre de producto	Used in Terminal Usado en borne	Pole Polos	Cross Section (mm ²) Sección transversal (mm ²)	Pack. Qty. Pzs
8013294523	PCC 2,5/2	PFT 2,5, PFT 2,5 1x2, PFT 2,5 2x2, PFT 2,5 2P, PFT 2,5 E	2	2,5	100
8013294533	PCC 2,5/3	PFT 2,5, PFT 2,5 1x2, PFT 2,5 2x2, PFT 2,5 2P, PFT 2,5 E	3	2,5	100
8013294503	PCC 2,5/10	PFT 2,5, PFT 2,5 1x2, PFT 2,5 2x2, PFT 2,5 2P, PFT 2,5 E	10	2,5	10
8013294623	PCC 4/2	PFT 4	2	4	100
8013294633	PCC 4/3	PFT 4	3	4	100
8013294603	PCC 4/10	PFT 4	10	4	10
8013294723	PCC 6/2	PFT 6	2	6	50
8013294733	PCC 6/3	PFT 6	3	6	50
8013294703	PCC 6/10	PFT 6	10	6	10
8013294823	PCC 10/2	PFT 10	2	10	10
8013294833	PCC 10/3	PFT 10	3	10	10

Sliding Connector

Puente deslizante

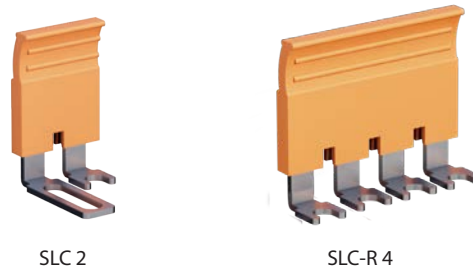

Order No. No. de orden	Product Name Nombre de producto	Used in Terminal Usado en borne	Pole Polos	Cross Section (mm ²) Sección transversal (mm ²)	Pack. Qty. Pzs
8013394923	SLC 2	TDT-C 6, TDT-V 6, TDS-C 6, TDS-V 6	2	6	50
8013394933	SLC 3	TDT-C 6, TDT-V 6, TDS-C 6, TDS-V 6	3	6	50
8013394943	SLC 4	TDT-C 6, TDT-V 6, TDS-C 6, TDS-V 6	4	6	50
8014393307	SLC-R 2	TDY-C 6	2	6	50
8014393317	SLC-R 3	TDY-C 6	3	6	50
8014393327	SLC-R 4	TDY-C 6	4	6	50

Marking Tags

Etiquetas de marcado

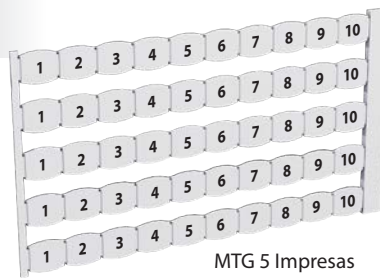

MTG 5 Impresas

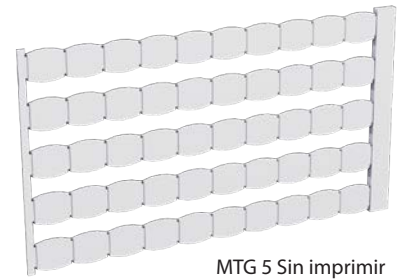

MTG 5 Sin imprimir

Product Code Código de producto	Product Name Nombre de producto	Description Descripción	Pack. Qty. Pzs
8020389019	MTG 5 impresas	Printed / Impresas	500
8020389009	MTG 5 Sin imprimir	Empty / Sin imprimir	500
8020389029	MTG 5 (1-10)	1-10	500
8020389039	MTG 5 (11-20)	11-20	500
8020389049	MTG 5 (21-30)	21-30	500
8020389059	MTG 5 (31-40)	31-40	500
8020389069	MTG 5 (41-50)	41-50	500
8020389079	MTG 5 (51-60)	51-60	500
8020389089	MTG 5 (61-70)	61-70	500
8020389099	MTG 5 (71-80)	71-80	500
8020389109	MTG 5 (81-90)	81-90	500
8020389119	MTG 5 (91-100)	91-100	500
8020389129	MTG 5 (1-50)	1-50	500
8020389139	MTG 5 (51-100)	51-100	500
8020389149	MTG 5 (101-150)	101-150	500
8020389159	MTG 5 (151-200)	151-200	500
8020389169	MTG 5 (201-250)	201-250	500
8020389179	MTG 5 (251-300)	251-300	500
8020389189	MTG 5 (301-350)	301-350	500
8020389199	MTG 5 (351-400)	351-400	500
8020389209	MTG 5 (401-450)	401-450	500
8020389219	MTG 5 (451-500)	451-500	500
8020388019	MTG 6 Impresas	Printed / Impresas	500
8020388009	MTG 6 Sin imprimir	Empty / Sin imprimir	500
8020388839	MTG 6 (L1, L2, L3, N)	L1, L2, L3, N	500
8020388309	MTG 6 (0)	0	500
8020388319	MTG 6 (1)	1	500
8020388599	MTG 6 (5)	5	500
8020388329	MTG 6 (2)	2	500
8020388339	MTG 6 (3)	3	500
8020388349	MTG 6 (4)	4	500
8020388359	MTG 6 (5)	5	500
8020388369	MTG 6 (6)	6	500
8020388379	MTG 6 (7)	7	500
8020388389	MTG 6 (8)	8	500
8020388399	MTG 6 (9)	9	500
8020388409	MTG 6 (10)	10	500
8020388029	MTG 6 (0-9)	0-9	500
8020388039	MTG 6 (1-10)	1-10	500
8020388879	MTG 6 (11-20)	11-20	500
8020388889	MTG 6 (21-30)	21-30	500
8020388899	MTG 6 (31-40)	31-40	500
8020388909	MTG 6 (41-50)	41-50	500
8020388919	MTG 6 (51-60)	51-60	500
8020388929	MTG 6 (61-70)	61-70	500
8020388939	MTG 6 (71-80)	71-80	500
8020388949	MTG 6 (81-90)	81-90	500
8020388959	MTG 6 (91-100)	91-100	500

Marking Tags

Etiquetas de marcado

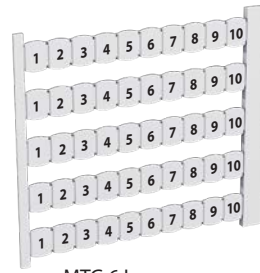

MTG 6 Impresas

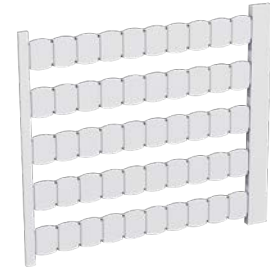

MTG 6 Sin imprimir

Product Code Código de producto	Product Name Nombre de producto	Description Descripción	Pack. Qty. Pzs
8020388049	MTG 6 (1-50)	1-50	500
8020388059	MTG 6 (51-100)	51-100	500
8020388069	MTG 6 (101-150)	101-150	500
8020388079	MTG 6 (151-200)	151-200	500
8020388089	MTG 6 (201-250)	201-250	500
8020388099	MTG 6 (251-300)	251-300	500
8020388109	MTG 6 (301-350)	301-350	500
8020388119	MTG 6 (351-400)	351-400	500
8020388129	MTG 6 (401-450)	401-450	500
8020388139	MTG 6 (451-500)	451-500	500
8020388149	MTG 6 (501-550)	501-550	500
8020388159	MTG 6 (551-600)	551-600	500
8020388169	MTG 6 (601-650)	601-650	500
8020388179	MTG 6 (651-700)	651-700	500
8020388189	MTG 6 (701-750)	701-750	500
8020388199	MTG 6 (751-800)	751-800	500
8020388209	MTG 6 (801-850)	801-850	500
8020388219	MTG 6 (851-900)	851-900	500
8020388229	MTG 6 (901-950)	901-950	500
8020388239	MTG 6 (951-1000)	951-1000	500
8020388859	MTG 6 (RSTN)	RSTN	500
8020388779	MTG 6 (+)	+	500
8020388789	MTG 6 (-)	-	500
8020388429	MTG 6 (B)	B	500
8020388849	MTG 6 (PE)	PE	500
8020388459	MTG 6 (E)	E	500
8020388529	MTG 6 (L)	L	500
8020388549	MTG 6 (N)	N	500
8020388659	MTG 6 (Y)	Y	500
8020388589	MTG 6 (R)	R	500
8020388829	MTG 6 (L1, L2, L3)	L1, L2, L3	500
8020388799	MTG 6 (L1)	L1	500
8020388809	MTG 6 (L2)	L2	500
8020388499	MTG 6 (I)	I	500
8020388449	MTG 6 (D)	D	500
8020388519	MTG 6 (K)	K	500
8020388469	MTG 6 (F)	F	500
8020388419	MTG 6 (A)	A	500
8020388539	MTG 6 (M)	M	500
8020388569	MTG 6 (P)	P	500
8020388679	MTG 6 (X1)	X1	500
8020388689	MTG 6 (X2)	X2	500
8020388699	MTG 6 (X3)	X3	500
8020388709	MTG 6 (X4)	X4	500
8020388719	MTG 6 (X5)	X5	500
8020388729	MTG 6 (X6)	X6	500
8020388739	MTG 6 (X7)	X7	500
8020388749	MTG 6 (X8)	X8	500

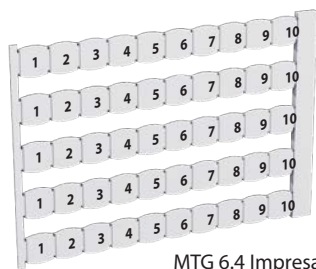

MTG 6.4 Impresas

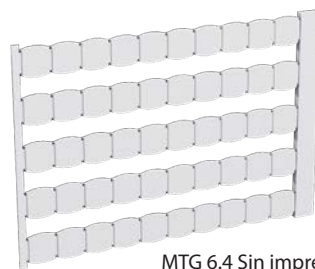

MTG 6.4 Sin impresas

Product Code Código de producto	Product Name Nombre de producto	Description Descripción	Pack. Qty. Pzs
8020388759	MTG 6 (X9)	X9	500
8020388769	MTG 6 (X10)	X10	500
8020388439	MTG 6 (C)	C	500
8020388629	MTG 6 (V)	V	500
8020388479	MTG 6 (G)	G	500
8020388489	MTG 6 (H)	H	500
8020388819	MTG 6 (L3)	L3	500
8020388869	MTG 6 (MP)	MP	500
8020388609	MTG 6 (T)	T	500
8020387019	MTG 6,4 Impresas	Printed / Impresas	500
8020387009	MTG 6,4 Sin imprimir	Empty / Sin imprimir	500
8020387309	MTG 6,4 (1)	1	500
8020387319	MTG 6,4 (2)	2	500
8020387329	MTG 6,4 (3)	3	500
8020387339	MTG 6,4 (4)	4	500
8020387349	MTG 6,4 (5)	5	500
8020387359	MTG 6,4 (6)	6	500
8020387369	MTG 6,4 (7)	7	500
8020387379	MTG 6,4 (8)	8	500
8020387389	MTG 6,4 (9)	9	500
8020387399	MTG 6,4 (10)	10	500
8020387029	MTG 6,4 (0-9)	0-9	500
8020387039	MTG 6,4 (1-50)	1-50	500
8020387049	MTG 6,4 (51-100)	51-100	500
8020387059	MTG 6,4 (101-150)	101-150	500
8020387069	MTG 6,4 (151-200)	151-200	500
8020387079	MTG 6,4 (201-250)	201-250	500
8020387089	MTG 6,4 (251-300)	251-300	500
8020387099	MTG 6,4 (301-350)	301-350	500
8020387109	MTG 6,4 (351-400)	351-400	500
8020387119	MTG 6,4 (401-450)	401-450	500
8020387129	MTG 6,4 (451-500)	451-500	500
8020387139	MTG 6,4 (501-550)	501-550	500
8020387149	MTG 6,4 (551-600)	551-600	500
8020387159	MTG 6,4 (601-650)	601-650	500
8020387169	MTG 6,4 (651-700)	651-700	500
8020387179	MTG 6,4 (701-750)	701-750	500
8020387189	MTG 6,4 (751-800)	751-800	500
8020387199	MTG 6,4 (801-850)	801-850	500
8020387209	MTG 6,4 (851-900)	851-900	500
8020387219	MTG 6,4 (901-950)	901-950	500
8020387229	MTG 6,4 (951-1000)	951-1000	500
8020387239	MTG 6,4 (1001-1050)	1001-1050	500
8020387249	MTG 6,4 (1051-1100)	1051-1100	500
8020386019	MTG 8 Impresas	Printed / Impresas	500
8020386009	MTG 8 Sin imprimir	Empty / Sin imprimir	500
8020386199	MTG 8 (0)	0	500
8020386209	MTG 8 (1)	1	500

Marking Tags

Etiquetas de marcado

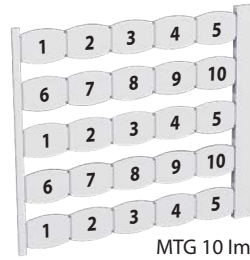

MTG 10 Impresas

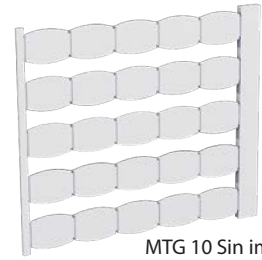

MTG 10 Sin imprimir

Product Code Código de producto	Product Name Nombre de producto	Description Descripción	Pack. Qty. Pzs
8020386219	MTG 8 (2)	2	500
8020386229	MTG 8 (3)	3	500
8020386239	MTG 8 (4)	4	500
8020386249	MTG 8 (5)	5	500
8020386259	MTG 8 (6)	6	500
8020386269	MTG 8 (7)	7	500
8020386279	MTG 8 (8)	8	500
8020386289	MTG 8 (9)	9	500
8020386299	MTG 8 (10)	10	500
8020386309	MTG 8 (0-9)	0-9	500
8020386319	MTG 8 (1-10)	1-10	500
8020386029	MTG 8 (1-50)	1-50	500
8020386039	MTG 8 (51-100)	51-100	500
8020386049	MTG 8 (101-150)	101-150	500
8020386059	MTG 8 (151-200)	151-200	500
8020386069	MTG 8 (201-250)	201-250	500
8020386079	MTG 8 (251-300)	251-300	500
8020386089	MTG 8 (301-350)	301-350	500
8020386099	MTG 8 (351-400)	351-400	500
8020386109	MTG 8 (401-450)	401-450	500
8020386119	MTG 8 (451-500)	451-500	500
8020386169	MTG 8 (701-750)	701-750	500
8020386189	MTG 8 (801-850)	801-850	500
8020386329	MTG 8 (+)	+	500
8020386339	MTG 8 (-)	-	500
8020386349	MTG 8 (PE)	PE	500
8020386359	MTG 8 (L)	L	500
8020386369	MTG 8 (N)	N	500
8020386379	MTG 8 (L1, L2, L3)	L1, L2, L3	500
8020386389	MTG 8 (L1)	L1	500
8020386399	MTG 8 (L2)	L2	500
8020386409	MTG 8 (L3)	L3	500
8020385019	MTG 10 Impresas	Printed / Impresas	250
8020385009	MTG 10 Sin imprimir	Empty / Sin imprimir	250
8020385029	MTG 10 (1)	1	250
8020385039	MTG 10 (2)	2	250
8020385049	MTG 10 (3)	3	250
8020385059	MTG 10 (4)	4	250
8020385069	MTG 10 (5)	5	250
8020385079	MTG 10 (6)	6	250
8020385089	MTG 10 (7)	7	250
8020385099	MTG 10 (8)	8	250
8020385109	MTG 10 (9)	9	250
8020385119	MTG 10 (10)	10	250
8020385129	MTG 10 (RSTN)	RSTN	250
8020385139	MTG 10 (L1)	L1	250
8020385149	MTG 10 (L2)	L2	250
8020385159	MTG 10 (L3)	L3	250

Mounting Rails

Rieles de montaje

Electrolytic white chromated & galvanized steel material

Material: Acero galvanizado y cromado blanco electrolítico

EN 50022 EN 50035 IEC 60715

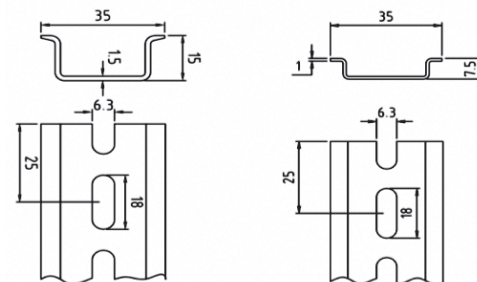

Product Code Código de producto	Product Name Nombre de producto	Dimensions / Dimensiones (mm)			Description Descripción	Unit Length Unidad de longitud (m)	Pack. Qty (Meter). Paquete (Metro)
		W	H	D			
8015393407	DR 35-7,5 S 2M	35	7,5	1	Slotted Din Rail / Riel DIN ranurado	2	40
8015393427	DR 35-15 S 2M	35	15	1,5	Slotted Din Rail / Riel DIN ranurado	2	20

Economical Range Mounting Rails

Línea económica de rieles de montaje

Product Code Código de producto	Product Name Nombre de producto	Dimensions / Dimensiones (mm)			Description Descripción	Unit Length Unidad de longitud (m)	Pack. Qty (Meter). Paquete (Metro)
		W	H	D			
8015393447	DR 35-7,5 E 2M	35	7,5	0,9	Slotted Rail / Riel ranurado	2	40

Rail Supports

Soportes de riel

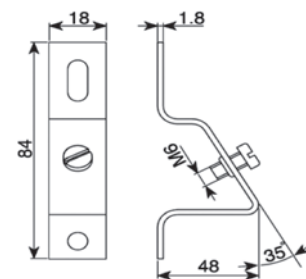

Product Code Código de producto	Product Name Nombre de producto	Description Descripción	Dia. Hole Diámetro del agujero	Packing Qty. Pzs
8015393507	ART - M6	35° Angeled Rail Support / Soporte de riel 35°	M6	50

Wiring Duct Cutter

Cortadora de canaleta



WDC 125

Product Code Código de producto	Product Name Nombre de producto	Description Descripción	Packing Qty. Pzs
8019391300	WDC 125	Flat-cut Table-top type cutter up to 120 mm duct width Cortadora de mesa de corte plano para canaletas de hasta 120 mm de ancho	1

Din Rail Cutters

Cortadoras de riel DIN



DRC 2W8R

DRC 1W

Product Code Código de producto	Product Name Nombre de producto	Description Descripción	Packing Qty. Pzs
8015393557	DRC 1W	1 way table-top type cutter for 35x7.5 Din Rail, up to 1.5 mm thickness Cortadora de mesa de 1 vía para riel DIN 35x7.5, hasta 1.5 mm de grosor	1
8015393567	DRC 2W8R	3 way table-top type cutter for 35x7.5, 35x15 Din Rails and 8 mm Rod Cortadora de mesa de 3 vías para riel DIN 35x7.5, 35x15, y barras de 8 mm	1

Panel Type Slotted Wiring Ducts

Canaletas ranuradas tipo panel

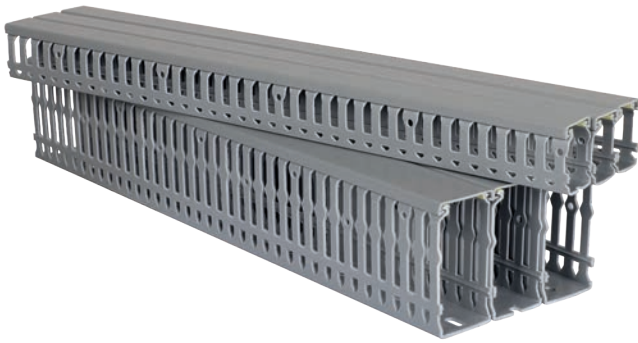

Self-extinguishing rigid PVC material

Material: PVC rígido autoextinguible

EN 50085-1+A

EN 50085-2-3

IEC 60695-2-11



Product Code Código de producto	Product Name Nombre de producto	Dimensions / Dimensiones (mm)		Color Color	Pack. Qty (Meter). Paquete (Metros)
		W	H		
8019391008	SWD 25x40 Panel Type Slotted WD / Canaleta ranurada tipo panel	25	40	Gray / Gris	60
8019391018	SWD 25x60 Panel Type Slotted WD / Canaleta ranurada tipo panel	25	60	Gray / Gris	40
8019391028	SWD 40x40 Panel Type Slotted WD / Canaleta ranurada tipo panel	40	40	Gray / Gris	40
8019391038	SWD 40x60 Panel Type Slotted WD / Canaleta ranurada tipo panel	40	60	Gray / Gris	36
8019391048	SWD 40x80 Panel Type Slotted WD / Canaleta ranurada tipo panel	40	80	Gray / Gris	28
8019391058	SWD 60x40 Panel Type Slotted WD / Canaleta ranurada tipo panel	60	40	Gray / Gris	32
8019391068	SWD 60x60 Panel Type Slotted WD / Canaleta ranurada tipo panel	60	60	Gray / Gris	24
8019391078	SWD 60x80 Panel Type Slotted WD / Canaleta ranurada tipo panel	60	80	Gray / Gris	16
8019391088	SWD 80x60 Panel Type Slotted WD / Canaleta ranurada tipo panel	80	60	Gray / Gris	20
8019391098	SWD 80x80 Panel Type Slotted WD / Canaleta ranurada tipo panel	80	80	Gray / Gris	16
8019391118	SWD 100x60 Panel Type Slotted WD / Canaleta ranurada tipo panel	100	60	Gray / Gris	12
8019391128	SWD 100x80 Panel Type Slotted WD / Canaleta ranurada tipo panel	100	80	Gray / Gris	8
8019391138	SWD 100x100 Panel Type Slotted WD / Canaleta ranurada tipo panel	100	100	Gray / Gris	8

Wiring Duct Covers

Cubiertas para canaletas

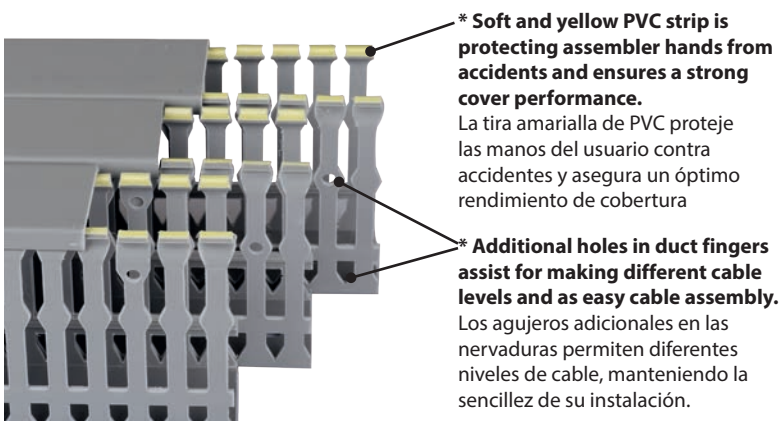

Product Code Código de producto	Product Name Nombre de producto	Width Ancho (mm.)	Length Longitud (m.)	Color Color	Pack. Qty (Meter). Paquete (Metros)
8019391208	SWC 25 Wiring Duct Covers / Cubiertas para canaletas	20	2	Gray / Gris	40
8019391218	SWC 40 Wiring Duct Covers / Cubiertas para canaletas	40	2	Gray / Gris	40
8019391228	SWC 60 Wiring Duct Covers / Cubiertas para canaletas	60	2	Gray / Gris	40
8019391238	SWC 80 Wiring Duct Covers / Cubiertas para canaletas	80	2	Gray / Gris	40
8019391248	SWC 100 Wiring Duct Covers / Cubiertas para canaletas	100	2	Gray / Gris	40

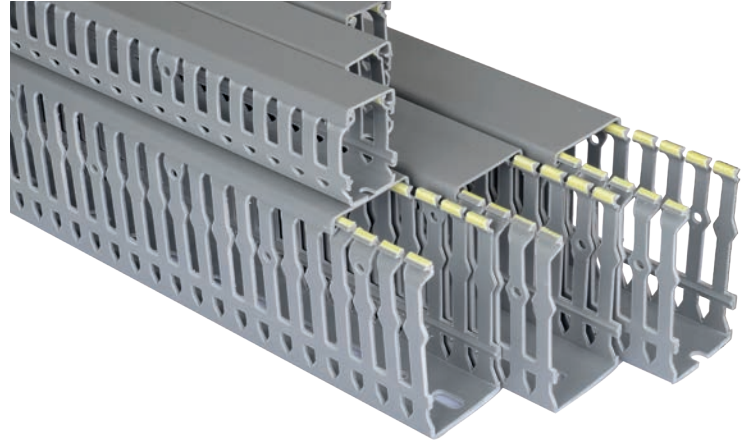
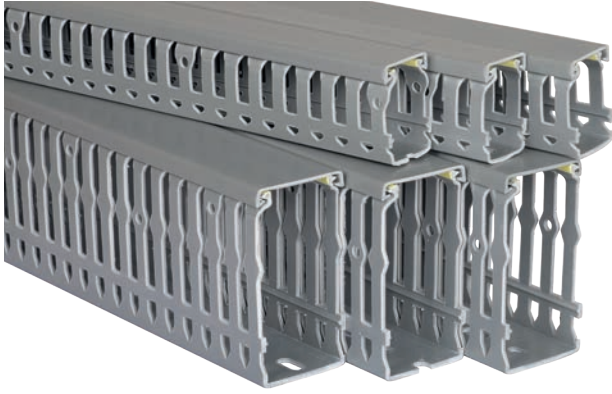

Product Code Código de producto	Product Name Nombre de producto	Dimensions / Dimensiones (mm)						Measured Total Cross Sec. Sec. Tran. total medida (mm ²)	Wire Filling Capacity (for 60% ratio) Capacidad de uso (Para una tasa del 60%)		
		W	H	E	F	G	Ø		2,5 mm ²	1,5 mm ²	1,0 mm ²
8019391008	SWD 25x40	25	40	6,5	5,9	12,8	4,5	820	35	51	78
8019391018	SWD 25x60	25	60	6,5	6	15,7	4,5	1.190	57	83	112
8019391028	SWD 40x40	40	40	6,5	5,9	12,8	4,5	1.360	65	94	129
8019391038	SWD 40x60	40	60	6,5	6	15,7	4,5	2.040	98	141	192
8019391048	SWD 40x80	40	80	6,5	6	19,8	4,5	2.700	130	187	255
8019391058	SWD 60x40	60	40	6,5	5,9	12,8	4,5	1.970	95	134	188
8019391068	SWD 60x60	60	60	6,5	6	15,7	4,5	3.080	148	214	291
8019391078	SWD 60x80	60	80	6,5	6	19,8	4,5	4.140	200	289	392
8019391088	SWD 80x60	80	60	6,5	6	15,7	4,5	4.150	200	288	391
8019391098	SWD 80x80	80	80	6,5	6	19,8	4,5	5.660	272	393	534
8019391118	SWD 100x60	100	60	6,5	6	15,7	4,5	5.250	254	364	491
8019391128	SWD 100x80	100	80	6,5	6	19,8	4,5	7.606	255	418	702
8019391138	SWD 100x100	100	100	6,5	6	19,8	4,5	8.920	430	619	812

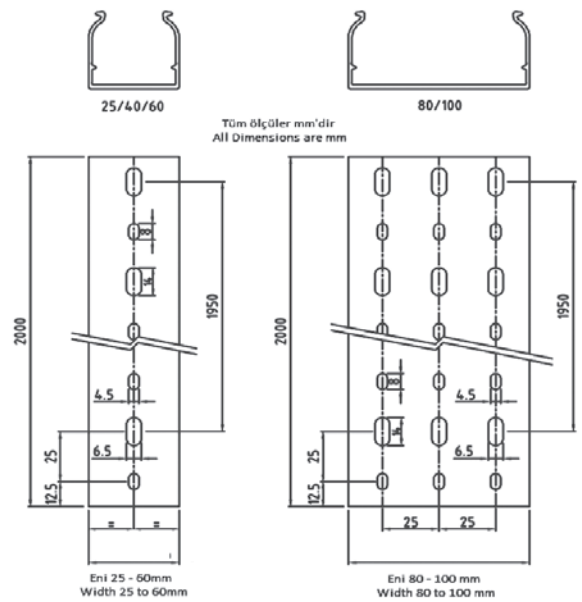
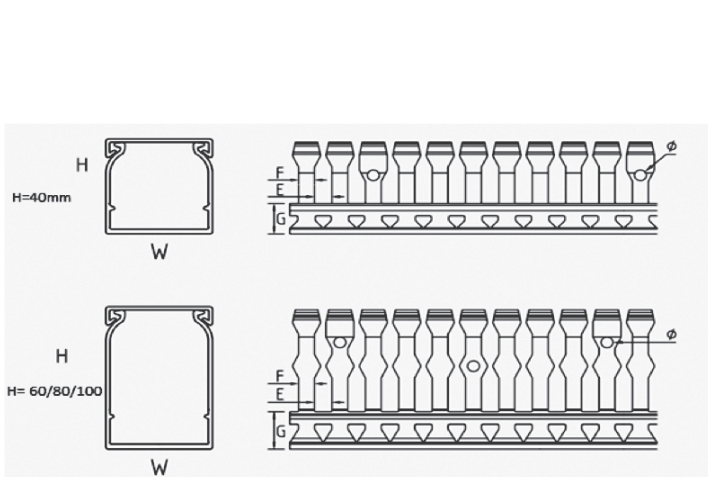

•Wiring ducts and covers are cut and packed in 2 m length.

• Las canaletas y coberturas son cortadas y empacadas con una longitud de 2 m.

Marking Systems

Sistemas de marcado



Thermal Transfer Printer

Impresora de transferencia térmica

Product Code Código de producto	Product Name Nombre de producto	Packing Qty. Pzs
8030129000	TBL TP2 Thermal Printer / Impresora térmica	1

Ribbons

Cintas



Product Code Código de producto	Product Name Nombre de producto	Inner Diameter Diámetro interno (mm)	Dimensions Dimensiones (mmxm)	Color Color	Packing Qty. Pzs
8030129110	RR Cinta 55x90	12,7 (½ inch)	55x90	Black / Negro	1
8030129120	RR Cinta 50x300	25,4 (1 inch)	50x300	Black / Negro	1
8030129130	RR Cinta 110x300	25,4 (1 inch)	110x300	Black / Negro	1

Terminal Blocks Strip Label

Etiqueta de tira para bornes

Product Code Código de producto	Product Name Nombre de producto	Dimensions Dimensiones (mmxm)	Color Color	Labels per Roll Etiquetas por rollo	Packing Qty. Pzs
8020384009	TBSL 22x20	22x20	White Blanco	2 pcs. of Strip Label Etiqueta de tira (2 pzs.)	1
8020384011	TBSL 5,15x5	25,75x20	White Blanco	5 pcs. of Strip Label Etiqueta de tira (5 pzs.)	1



TBSL 22x20



Cable Marking Plates (for Transparent Sleeves)

Placas de marcado de cable (Para soportes transparentes)

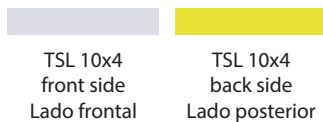

TSL 10x4
front side
Lado frontal

TSL 10x4
back side
Lado posterior

Product Code Código de producto	Product Name Nombre de producto	Print Area Área de impresión (mm)	Description Descripción	Packing Qty. Pzs
8021340004	TSL 10x4 Yellow - White / Amarilla - Blanco	10 x 4	Folded Plegado	3.000
8021340104	TSL 12x4 Yellow - White / Amarilla - Blanco	12 x 4	Folded Plegado	3.000
8021340014	TSL 15x4 Yellow - White / Amarilla - Blanco	15 x 4	Folded Plegado	3.000
8021340024	TSL 20x4 Yellow - White / Amarilla - Blanco	20 x 4	Folded Plegado	3.000
8021340034	TSL 30x4 Yellow - White / Amarilla - Blanco	30 x 4	Folded Plegado	3.000

Transparent Sleeves - Closed / Insertion Type

Soportes transparentes - Cerrados / Tipo inserción



TS 10 1,5-2,5



TS 10 2,5-4,0



TS 10 6,0-10



TS 10 16-25

Product Code Código de producto	Product Name Nombre de producto	Length Longitud (mm)	Color Color	Cond. Cross Sec. Sec. Tran. del conductor (mm ²)	Packing Qty. Pzs
8021343019	TS 10 1,5-2,5	10	Transparent / Transparente	1,5 - 2,5	500
8021343029	TS 12 1,5-2,5	12	Transparent / Transparente	1,5 - 2,5	500
8021343039	TS 15 1,5-2,5	15	Transparent / Transparente	1,5 - 2,5	500
8021343049	TS 20 1,5-2,5	20	Transparent / Transparente	1,5 - 2,5	500
8021343059	TS 30 1,5-2,5	30	Transparent / Transparente	1,5 - 2,5	500
8021344019	TS 10 2,5-4,0	10	Transparent / Transparente	2,5 - 4	500
8021344029	TS 12 2,5-4,0	12	Transparent / Transparente	2,5 - 4	500
8021344039	TS 15 2,5-4,0	15	Transparent / Transparente	2,5 - 4	500
8021344049	TS 20 2,5-4,0	20	Transparent / Transparente	2,5 - 4	500
8021344059	TS 30 2,5-4,0	30	Transparent / Transparente	2,5 - 4	500
8021345019	TS 10 6,0-10	10	Transparent / Transparente	6 - 10	500
8021345029	TS 12 6,0-10	12	Transparent / Transparente	6 - 10	500
8021345039	TS 15 6,0-10	15	Transparent / Transparente	6 - 10	500
8021345049	TS 20 6,0-10	20	Transparent / Transparente	6 - 10	500
8021345059	TS 30 6,0-10	30	Transparent / Transparente	6 - 10	500
8021346019	TS 10 16-25	10	Transparent / Transparente	16 - 25	500
8021346029	TS 12 16-25	12	Transparent / Transparente	16 - 25	500
8021346039	TS 15 16-25	15	Transparent / Transparente	16 - 25	500
8021346049	TS 20 16-25	20	Transparent / Transparente	16 - 25	200
8021346059	TS 30 16-25	30	Transparent / Transparente	16 - 25	200

Slim Adhesive Labels (For Panel Surface, Contactors and Other Devices Inside Panel)

Etiquetas adhesivas delgadas (Para superficie de panel, contactores y otros dispositivos dentro del panel)



SPEL 27x15



SPEL 35x15



SPEL 15x6

Product Code Código de producto	Product Name Nombre de producto	Print Area Area de impresión (mm)	Color Color	Packing Qty. Pzs
8022120004	SPEL 12x9	12x9	Yellow / Amarillo	2.500
8022120008	SPEL 12x9	12x9	Silver / Plata	2.500
8022120009	SPEL 12x9	12x9	White / Blanco	2.500
8022120014	SPEL 15x6	15x6	Yellow / Amarillo	2.500
8022120018	SPEL 15x6	15x6	Silver / Plata	2.500
8022120019	SPEL 15x6	15x6	White / Blanco	2.500
8022120024	SPEL 15x9	15x9	Yellow / Amarillo	2.500
8022120028	SPEL 15x9	15x9	Silver / Plata	2.500
8022120029	SPEL 15x9	15x9	White / Blanco	2.500
8022120034	SPEL 17x10	17x10	Yellow / Amarillo	2.500
8022120038	SPEL 17x10	17x10	Silver / Plata	2.500
8022120039	SPEL 17x10	17x10	White / Blanco	2.500
8022120044	SPEL 20x8	20x8	Yellow / Amarillo	2.500
8022120048	SPEL 20x8	20x8	Silver / Plata	2.500
8022120049	SPEL 20x8	20x8	White / Blanco	2.500
8022120054	SPEL 27x12,5	27x12	Yellow / Amarillo	2.500
8022120058	SPEL 27x12,5	27x12	Silver / Plata	2.500
8022120059	SPEL 27x12,5	27x12	White / Blanco	2.500
8022120064	SPEL 27x15	27x15	Yellow / Amarillo	2.500
8022120068	SPEL 27x15	27x15	Silver / Plata	2.500
8022120069	SPEL 27x15	27x15	White / Blanco	2.500
8022120074	SPEL 27x18	27x18	Yellow / Amarillo	2.500
8022120078	SPEL 27x18	27x18	Silver / Plata	2.500
8022120079	SPEL 27x18	27x18	White / Blanco	2.500
8022120098	SPEL 35x18	35x18	Silver / Plata	1.500
8022120108	SPEL 45x15	45x15	Silver / Plata	2.000
8022120118	SPEL 70x30	70x30	Silver / Plata	250
8022120128	SPEL 90x40	90x40	Silver / Plata	250
8022120138	SPEL 100x50	100x50	Silver / Plata	250



Thick Adhesive Labels (For Panel Surface)

Etiquetas adhesivas gruesas (Para superficie de panel)



TPEL 40x30



TPEL 60x15



TPEL 45x15

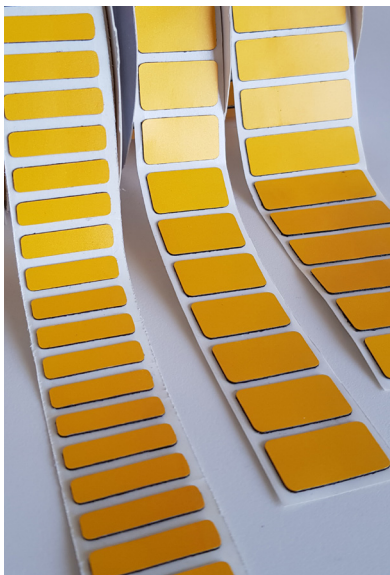

Product Code Código de producto	Product Name Nombre de producto	Print Area Area de impresión (mm)	Color Color	Packing Qty. Pzs
8022130014	TPEL 22x22	22x22	Yellow / Amarillo	150
8022130018	TPEL 22x22	22x22	Silver / Plata	150
8022130019	TPEL 22x22	22x22	White / Blanco	150
8022130004	TPEL 27x12,5	27x12	Yellow / Amarillo	150
8022130008	TPEL 27x12,5	27x12	Silver / Plata	150
8022130009	TPEL 27x12,5	27x12	White / Blanco	150
8022130024	TPEL 27x15	27x15	Yellow / Amarillo	150
8022130028	TPEL 27x15	27x15	Silver / Plata	150
8022130029	TPEL 27x15	27x15	White / Blanco	150
8022130109	TPEL 27x18	27x18	Yellow / Amarillo	150
8022130108	TPEL 27x18	27x18	Silver / Plata	150
8022130104	TPEL 27x18	27x18	White / Blanco	150
8022130034	TPEL 27x27	27x27	Yellow / Amarillo	150
8022130038	TPEL 27x27	27x27	Silver / Plata	150
8022130039	TPEL 27x27	27x27	White / Blanco	150
8022130044	TPEL 35x18	35x18	Yellow / Amarillo	150
8022130048	TPEL 35x18	35x18	Silver / Plata	150
8022130049	TPEL 35x18	35x18	White / Blanco	150
8022130054	TPEL 40x30	40x30	Yellow / Amarillo	125
8022130058	TPEL 40x30	40x30	Silver / Plata	125
8022130059	TPEL 40x30	40x30	White / Blanco	125
8022130064	TPEL 45x15	45x15	Yellow / Amarillo	150
8022130068	TPEL 45x15	45x15	Silver / Plata	150
8022130069	TPEL 45x15	45x15	White / Blanco	150
8022130074	TPEL 60x15	60x15	Yellow / Amarillo	150
8022130078	TPEL 60x15	60x15	Silver / Plata	150
8022130079	TPEL 60x15	60x15	White / Blanco	150
8022130084	TPEL 60x30	60x30	Yellow / Amarillo	125
8022130088	TPEL 60x30	60x30	Silver / Plata	125
8022130089	TPEL 60x30	60x30	White / Blanco	125
8022130094	TPEL 90x45	90x45	Yellow / Amarillo	50
8022130098	TPEL 90x45	90x45	Silver / Plata	50
8022130099	TPEL 90x45	90x45	White / Blanco	50



Push Button Labels (Suitable for 22 mm Diameter)

Etiquetas para botones (Adecuados para diámetros de 22 mm)



TPBL 30x40

Product Code Código de producto	Product Name Nombre de producto	Print Area Area de impresión (mm)	Color Color	Hole Dia. Dia. del agujero (mm)	Packing Qty. Pzs
8022130114	TPBL 30x40	30 x 13	Yellow / Amarillo	23,5	100
8022130118	TPBL 30x40	30 x 13	Silver / Plata	23,5	100
8022130119	TPBL 30x40	30 x 13	White / Blanco	23,5	100



TPBL 30x40

Push Button Labels (Suitable for 22 mm Diameter)

Portaetiquetas para botones (Adecuados para diámetros de 22 mm)



TBET 50X30 TBET 40X30

Product Code Código de producto	Product Name Nombre de producto	Print Area Area de impresión (mm)	Color Color	Packing Qty. Pzs
8022130330	TBET 40x30	25 x 8	Black / Negro	60
8022130340	TBET 50x30	25 x 18	Black / Negro	60

Empty printing papers are inside the package

Las etiquetas en blanco se encuentran dentro del paquete

Self Adhesive Panel Labels Holders

Soportes para etiquetas de panel autoadhesivos



TYPET 17x75



TYPET 17x50



TYPET 17x30

Product Code Código de producto	Product Name Nombre de producto	Print Area Area de impresión (mm)	Color Color	Packing Qty. Pzs
8022130300	TYPET 17x30	27 x 14	Black / Negro	100
8022130310	TYPET 17x50	49 x 15	Black / Negro	50
8022130320	TYPET 17x75	72 x 15	Black / Negro	25

Empty printing papers are inside the package

Las etiquetas en blanco se encuentran dentro del paquete



Labels for Terminal Blocks Group Markers

Etiquetas para marcadores de grupo (Bornes)

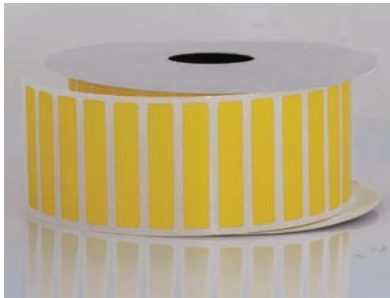

GML 2 36x7

Product Code Código de producto	Product Name Nombre de producto	Print Area Area de impresión (mm)	Color Color	Description Descripción	Packing Qty. Pzs
8022130124	GML 1 36x17	36 x 17	Yellow / Amarillo	GM 1	2.000
8022130134	GML 2 36x7	36 x 7	Yellow / Amarillo	GM 2	2.000



Self Adhesive Endless Labels

Etiquetas tipo cinta (Sin seccionar) autoadhesivas

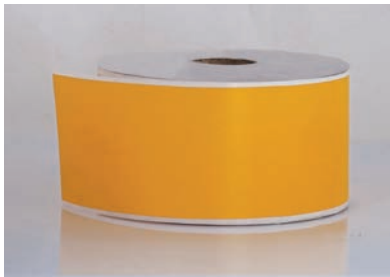

SALT 5x20

Product Code Código de producto	Product Name Nombre de producto	Dimensions Dimensiones (mmxm)	Color Color	Packing Qty. Pzs
8022130144	SALT 5x20	50 x 20	Yellow / Amarillo	1
8022130128	SALT 5x20	50 x 20	Silver / Plata	1
8022130129	SALT 5x20	50 x 20	White / Blanco	1

Emergency Stop Labels (Suitable for 22mm Diameter)

Etiquetas de parado de emergencia (Adecuadas para 22 mm de diámetro)

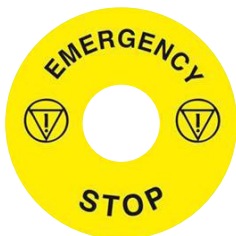

Product Code Código de producto	Product Name Nombre de producto	Label Dia. Diá. de la etiqueta (mm)	Hole Dia. Diá. del agujero (mm)	Color Color	Packing Qty. Pzs
8022130350	ASE60	60	23,5	Yellow / Amarillo	1

Labels Assembled with Cable Ties (Directly Assembled to Cable Ties)

Etiquetas de montaje con bridas (Instaladas directamente en las bridas)



RCTL 50x15

HCTL 25x10

Product Code Código de producto	Product Name Nombre de producto	Print Area Area de impresión (mm)	Color Color	Description Descripción	Packing Qty. Pzs
8021341019	HCTL 25x10	25 x 10	White / Blanco	Hexagonal / Hexagonal	250
8021342019	RCTL 25x10	25 x 10	White / Blanco	Rectangular / Rectangular	250
8021342029	RCTL 50x15	50 x 15	White / Blanco	Rectangular / Rectangular	250
8021342039	RCTL 60x30	60 x 30	White / Blanco	Rectangular / Rectangular	250

Labels Assembled with Cable Ties (Assembled with Label Holder)

Etiquetas de montaje con bridas (Instaladas con portaetiquetas)

Product Code Código de producto	Product Name Nombre de producto	Print Area Area de impresión (mm)	Color Color	Description Descripción	Packing Qty. Pzs
8021334009	CM 1		White / Blanco	Label Holder 1 / Portaetiqueta 1	100
8021334019	CM 2		White / Blanco	Label Holder 2 / Portaetiqueta 2	100

Empty printing papers are inside the package

Las etiquetas en blanco se encuentran dentro del paquete

Product Code Código de producto	Product Name Nombre de producto	Color Color	Dimensions / Dimensiones		
			L	W	T
8021334009	CM 1	White / Blanco	35	10	8
8021334019	CM 2	White / Blanco	45	20	8

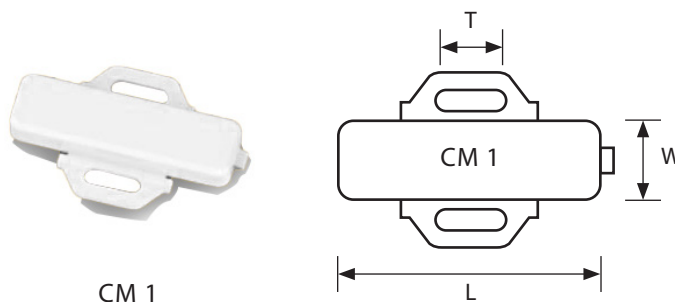

CM 1

Plastic Cable Ties

Bridas plásticas para cable

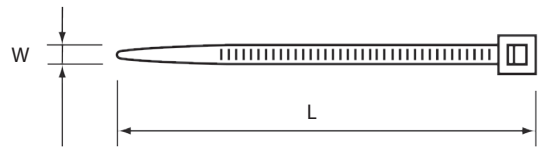

Product Code Código de producto	Product Name Nombre de producto	Dimensions Dimensiones (LxW) (mm)	Max. Bundle Dia. Máx. Diá. de amarre (mm)	Min. Loop Tensile Strength Tensión Mín. de sujeción (kg.)	Pack. Qty Qty (Pcs./Pzs)	Carton Qty. Qty. (Pcs./Pzs)
8016330109	PCT 100 x 2.5 White / Blanco	100 x 2.5	22	8	100	26.000
8016330110	PCT 100 x 2.5 Black / Negro	100 x 2.5	22	8	100	26.000
8016330209	PCT 150 x 2.5 White / Blanco	150 x 2.5	35	8	100	20.000
8016330210	PCT 150 x 2.5 Black / Negro	150 x 2.5	35	8	100	20.000
8016330309	PCT 200 x 2.5 White / Blanco	200 x 2.5	55	8	100	18.000
8016330310	PCT 200 x 2.5 Black / Negro	200 x 2.5	55	8	100	18.000
8016330409	PCT 140 x 3.6 White / Blanco	140 x 3.6	36	18	100	12.000
8016330410	PCT 140 x 3.6 Black / Negro	140 x 3.6	36	18	100	12.000
8016330509	PCT 200 x 3.6 White / Blanco	200 x 3.6	52	18	100	10.000
8016330510	PCT 200 x 3.6 Black / Negro	200 x 3.6	52	18	100	10.000
8016330609	PCT 250 x 3.6 White / Blanco	250 x 3.6	68	18	100	8.000
8016330610	PCT 250 x 3.6 Black / Negro	250 x 3.6	68	18	100	8.000
8016330709	PCT 280 x 3.6 White / Blanco	280 x 3.6	82	18	100	8.000
8016330710	PCT 280 x 3.6 Black / Negro	280 x 3.6	82	18	100	8.000
8016330809	PCT 370 x 3.6 White / Blanco	370 x 3.6	105	18	100	6.000
8016330810	PCT 370 x 3.6 Black / Negro	370 x 3.6	105	18	100	6.000
8016331009	PCT 200 x 4.8 White / Blanco	200 x 4.8	49	22	100	7.000
8016331010	PCT 200 x 4.8 Black / Negro	200 x 4.8	49	22	100	7.000
8016331209	PCT 250 x 4.8 White / Blanco	250 x 4.8	68	22	100	6.000
8016331210	PCT 250 x 4.8 Black / Negro	250 x 4.8	68	22	100	6.000
8016331309	PCT 300 x 4.8 White / Blanco	300 x 4.8	83	22	100	5.000
8016331310	PCT 300 x 4.8 Black / Negro	300 x 4.8	83	22	100	5.000
8016331509	PCT 370 x 4.8 White / Blanco	370 x 4.8	105	22	100	4.000
8016331510	PCT 370 x 4.8 Black / Negro	370 x 4.8	105	22	100	4.000
8016331709	PCT 430 x 4.8 White / Blanco	430 x 4.8	125	22	100	3.000
8016331710	PCT 430 x 4.8 Black / Negro	430 x 4.8	125	22	100	3.000
8016332009	PCT 300 x 7.6 White / Blanco	300 x 7.6	80	55	100	3.000
8016332010	PCT 300 x 7.6 Black / Negro	300 x 7.6	80	55	100	3.000
8016332209	PCT 370 x 7.6 White / Blanco	370 x 7.6	101	55	100	2.500
8016332210	PCT 370 x 7.6 Black / Negro	370 x 7.6	101	55	100	2.500
8016332309	PCT 450 x 7.6 White / Blanco	450 x 7.6	128	55	100	2.500
8016332310	PCT 450 x 7.6 Black / Negro	450 x 7.6	128	55	100	2.500
8016332329	PCT 550 x 7.6 White / Blanco	550 x 7.6	155	55	100	1.500
8016332320	PCT 550 x 7.6 Black / Negro	550 x 7.6	155	55	100	1.500
8016332339	PCT 750 x 7.6 White / Blanco	750 x 7.6	220	55	100	1.200
8016332330	PCT 750 x 7.6 Black / Negro	750 x 7.6	220	55	100	1.200
8016332409	PCT 600 x 9.0 White / Blanco	600 x 9.0	160	80	100	1.200
8016332410	PCT 600 x 9.0 Black / Negro	600 x 9.0	160	80	100	1.200
8016332609	PCT 760 x 9.0 White / Blanco	760 x 9.0	227	80	100	1.200
8016332610	PCT 760 x 9.0 Black / Negro	760 x 9.0	227	80	100	1.200
8016332709	PCT 900 x 9.0 White / Blanco	900 x 9.0	275	80	100	1.200
8016332710	PCT 900 x 9.0 Black / Negro	900 x 9.0	275	80	100	1.200

- Black colored cable ties are UV (Ultraviolet) resistant.
- Las bridas de color negro son resistentes a rayos UV (Ultravioleta).

Self Adhesive Tie Mounts

Monturas de fijación autoadhesivas

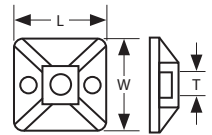

Product Code Código de producto	Product Name Nombre de producto	Dimensions / Dimensiones (mm)			Pack. Qty Qty (Pcs./Pzs)
		L	W	T	
8016333009	ATM 19 x 19 White / Blanco	19	19	3,6	100
8016333010	ATM 19 x 19 Black / Negro	19	19	3,6	100
8016333109	ATM 28 x 28 White / Blanco	28	28	4,8	100
8016333110	ATM 28 x 28 Black / Negro	28	28	4,8	100

Screw Type Tie Mounts

Monturas de fijación de tipo tornillo

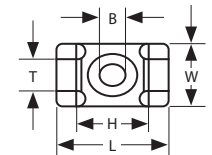

Product Code Código de producto	Product Name Nombre de producto	Dimensions / Dimensiones (mm)					Pack. Qty Qty (Pcs./Pzs)
		L	W	H	T	B	
8016334009	STM 1 White / Blanco	17,8	12,7	8,15	4,8	M3	100
8016334019	STM 2 White / Blanco	25,4	16	10,8	9	M5	100
8016334010	STM 1 Black / Negro	17,8	12,7	8,15	4,8	M3	100
8016334020	STM 2 Black / Negro	25,4	16	10,8	9	M5	100

Cable Tie Tightening and Cutting Tool

Herramienta para ajuste y corte de bridas



Product Code Código de producto	Product Name Nombre de producto	Function Función	Max. Cable Tie Width Máx. grosor de brida (mm)	Pack. Qty Qty (Pcs./Pzs)
8016334200	CTT1	Tightening + Cutting Ajuste + Corte	4,8	1

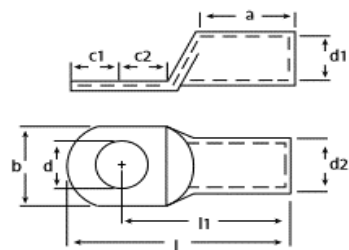

Product Code Código de producto	Product Name Nombre de producto	Cross Sec. Sec. Trans. (mm ²)	Dimensions / Dimensiones (mm)									Hole Dia. Diá. del Agujero	Pack. Qty Qty (Pcs./Pzs)
			d	d1	d2	l	l1	a	b	c1	c2		
8029320610	CCL 10mm² M6	10	6,5	4,4	6	27,5	21,7	10	10,4	6	6	M6	500
8029320620	CCL 10mm² M8	10	8,5	4,4	6	27,5	21,7	10	13,7	6	6	M8	500
8029320630	CCL 16mm² M6	16	6,5	5,5	8	32,6	24,9	12	11,4	7	8	M6	300
8029320640	CCL 16mm² M8	16	8,5	5,5	8	32,6	24,9	12	13,9	7	8	M8	300
8029320641	CCL 16mm ² M10	16	10,5	5,5	8	32,6	24,9	12	16,1	7	8	M10	300
8029320649	CCL 25mm ² M6	25	6,5	6,8	9	39	32,3	16	13,6	6,8	9,2	M6	200
8029320650	CCL 25mm² M8	25	8,5	6,8	9	39	32,3	16	13,7	6,8	9,2	M8	200
8029320651	CCL 25mm ² M10	25	10,5	7	9,5	42	34,1	16	16,1	6,8	11	M10	200
8029320659	CCL 35mm ² M6	35	6,5	8,2	11	44	35,6	19	15,9	8,3	9,7	M6	150
8029320660	CCL 35mm² M8	35	8,5	8,2	11	44	35,6	19	15,9	8,3	9,7	M8	150
8029320661	CCL 35mm ² M10	35	10,5	8,2	11	48	37,9	19	15,8	10	12	M10	150
8029320669	CCL 50mm ² M8	50	8,5	9,5	12	47,5	39,3	21	17,8	8,3	9,7	M8	100
8029320670	CCL 50mm² M10	50	10,5	9,5	12	51,5	41,6	21	17,9	10	12	M10	100
8029320671	CCL 50mm ² M12	50	13	10,1	13	51,5	41,6	21	19,2	10	12	M12	100
8029320672	CCL 50mm ² M14	50	15	10,1	13	56,5	44,6	21	20,7	12	15	M14	100
8029320679	CCL 70mm ² M8	70	8,5	11,2	14,5	54,6	44,5	23	21,2	10	12	M8	75
8029320680	CCL 70mm² M10	70	10,5	11,2	14,5	54,6	44,5	23	21,2	10	12	M10	75
8029320681	CCL 70mm ² M12	70	13	11,2	14,5	54,6	44,5	23	21,3	10	12	M12	75
8029320682	CCL 70mm ² M14	70	15	11,2	14,5	62,6	47,5	23	21,5	15	15	M14	75
8029320689	CCL 95mm ² M8	95	8,5	13,4	17	58,8	48,9	26	24,7	10	12	M8	50
8029320690	CCL 95mm² M10	95	10,5	13,4	17	58,8	48,9	26	24,7	10	12	M10	50
8029320700	CCL 95mm² M12	95	13	13,4	17	58,8	48,9	26	24,6	10	12	M12	50
8029320709	CCL 120mm ² M10	120	10,5	15,5	19	69	55,9	29	28,1	13	14,5	M10	40
8029320710	CCL 120mm² M12	120	13	15,5	19	69	55,9	29	28,2	13	14,5	M12	40
8029320711	CCL 120mm ² M16	120	17	15,5	19	69	55,9	29	28,2	13	14,5	M16	40
8029320719	CCL 150mm ² M10	150	10,5	16,5	16,5	76,5	59,9	30	30,2	16,5	16,5	M10	30
8029320720	CCL 150mm² M12	150	13	16,5	21	76,5	59,9	30	30,1	16,5	16,5	M12	30
8029320721	CCL 150mm ² M16	150	17	16,5	21	76,5	59,9	30	30,1	16,5	16,5	M16	30
8029320729	CCL 185mm ² M12	185	13	18,5	23	82,5	65,6	33	34,2	17	18	M12	25
8029320730	CCL 185mm² M16	185	17	18,5	23	82,5	65,6	33	34,1	17	18	M16	25
8029320739	CCL 240mm ² M12	240	13	21	26	89	72,1	38	38,2	17	18	M12	20
8029320740	CCL 240mm² M16	240	17	21	26	89	72,1	38	38,2	17	18	M16	20



Material : EN 13600 Standarts Electrolytically Tin (E-Cu) Plated Copper
Plating : Minimum 3 microns (µm) Tin Plated

Material : Estándar EN 13600 - Cobre laminado de estaño (E-Cu) Electr.
 Laminado : Laminado de estaño de mínimo 3 micrones (µm)

**** Bold fonted items are our standart sizes, pls ask stock availability for other items.**

**** Los elementos en negrita son del tamaño estándar, por favor preguntar disponibilidad en stock para cualquier otro ítem.**

Compression Cable Lugs - Eco Line

Terminales de compresión tipo ojo - Línea Eco

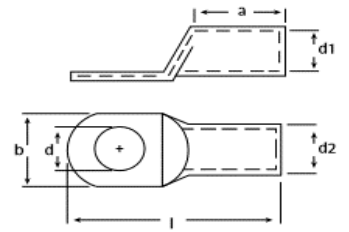

Product Code Código de producto	Product Name Nombre de producto	Cross Sec. Sec. Trans. (mm ²)	Dimensions / Dimensiones (mm)						Hole Dia. Diá. del Agujero	Pack. Qty Qty (Pcs./Pzs)
			d	d1	d2	l	a	b		
8029320500	CCL-E 16 M6	16	6,5	5,5	7	32,5	11	10,5	M6	500
8029320510	CCL-E 16 M8	16	8,5	5,5	7	32,5	11	13	M8	500
8029320520	CCL-E 25 M8	25	8,5	7	9	38,5	16	13	M8	300
8029320530	CCL-E 35 M8	35	8,5	8,5	10,5	43,5	19	15,5	M8	200
8029320540	CCL-E 50 M10	50	10,5	10	12	51,5	21	17,6	M10	125
8029320550	CCL-E 70 M10	70	10,5	11,5	14	55,5	23	20,7	M10	100
8029320560	CCL-E 95 M12	95	13	13,5	16	58,5	26	23,5	M12	75
8029320570	CCL-E 120 M12	120	13	15,5	18	71	29	26,7	M12	50
8029320580	CCL-E 150 M12	150	13	16,5	20	76	30	29,2	M12	30
8029320590	CCL-E 185 M16	185	17	18,5	22	82	33	32,3	M16	25
8029320600	CCL-E 240 M16	240	17	21,5	25,5	91	38	37,6	M16	20

Material : EN 13600 Standarts Electrolytically Tin (E-Cu) Plated Copper
Plating : Minimum 3 microns (µm) Tin Plated

Material : Estándar EN 13600 - Cobre laminado de estaño (E-Cu) Electr.
Laminado : Laminado de estaño de mínimo 3 micrones (µm)



Standard Range Compression Butt Terminals

Terminales de compresión para uniones - Línea estándar

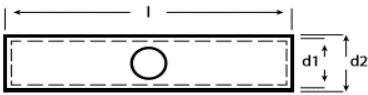

Product Code Código de producto	Product Name Nombre de producto	Cross Sec. Sec. Trans. (mm ²)	Dimensions / Dimensiones (mm)			Pack. Qty Qty (Pcs./Pzs)
			d1	d2	l	
8029320845	CBT 10	10	4,4	6	27	400
8029320850	CBT 16	16	5,5	8	32	250
8029320860	CBT 25	25	7	9	40,5	200
8029320870	CBT 35	35	8,2	11	45,5	150
8029320880	CBT 50	50	9,5	13	53,5	80
8029320890	CBT 70	70	11,2	14,5	57,5	60
8029320900	CBT 95	95	13,4	17	61,5	40
8029320910	CBT 120	120	15	19,5	74	30
8029320920	CBT 150	150	16,5	21	79	25
8029320930	CBT 185	185	19	24	85	18
8029320940	CBT 240	240	21	26	95	13

Material : EN 13600 Standarts Electrolytically Tin (E-Cu) Plated Copper
Plating : Minimum 3 microns (µm) Tin Plated

Material : Estándar EN 13600 - Cobre laminado de estaño (E-Cu) Electr.
 Laminado : Laminado de estaño de mínimo 3 micrones (µm)

Economical Range Compression Butt Terminals

Terminales de compresión para uniones - Línea económica

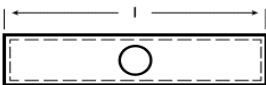

Product Code Código de producto	Product Name Nombre de producto	Cross Sec. Sec. Trans. (mm ²)	Length Longitud (l) mm	Pack. Qty Qty (Pcs./Pzs)
8029320750	CBT-E 16	16	32	300
8029320760	CBT-E 25	25	41	200
8029320770	CBT-E 35	35	46	150
8029320780	CBT-E 50	50	54	125
8029320790	CBT-E 70	70	58	100
8029320800	CBT-E 95	95	62	60
8029320810	CBT-E 120	120	74	40
8029320820	CBT-E 150	150	80	30
8029320830	CBT-E 185	185	86	22
8029320840	CBT-E 240	240	95	15

Material : EN 13600 Standarts Electrolytically Tin (E-Cu) Plated Copper
Plating : Minimum 3 microns (µm) Tin Plated

Material : Estándar EN 13600 - Cobre laminado de estaño (E-Cu) Electr.
 Laminado : Laminado de estaño de mínimo 3 micrones (µm)

Insulated Ring Terminals

Terminales aislados de anillo

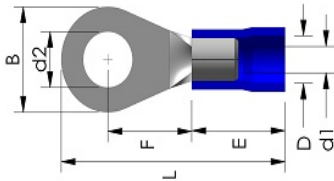

Material: Copper, Tin Plated
Material: Cobre, Estañado
Isolation / Aislamiento PVC

Product Code Código de producto	Product Name Nombre de producto	Cross Sec. Sec. Trans. (mm ²)	Dimensions / Dimensiones (mm)							Color Color	Pack. Qty Qty (Pcs./Pzs)
			d2	B	F	L	E	D	d1		
8018335500	IRT 301	0,5 - 1,5	3,2	5,5	4	16,7	10	4,1	1,7	Red / Rojo	200
8018335510	IRT 351	0,5 - 1,5	3,7	5,5	4	16,7	10	4,1	1,7	Red / Rojo	200
8018335520	IRT 401	0,5 - 1,5	4,3	6,6	6,3	19,6	10	4,1	1,7	Red / Rojo	200
8018335530	IRT 501	0,5 - 1,5	5,3	8	7	21	10	4,1	1,7	Red / Rojo	200
8018335540	IRT 601	0,5 - 1,5	6,5	11,6	11,1	26,8	10	4,1	1,7	Red / Rojo	200
8018335550	IRT 801	0,5 - 1,5	8,4	11,6	11,1	26,8	10	4,1	1,7	Red / Rojo	200
8018335560	IRT 302	1,5 - 2,5	3,2	6,4	4,3	17,5	10	4,5	2,3	Blue / Azul	200
8018335570	IRT 402	1,5 - 2,5	4,3	6,6	6,3	19,5	10	4,5	2,3	Blue / Azul	200
8018335580	IRT 502	1,5 - 2,5	5,3	8,5	7,8	22	10	4,5	2,3	Blue / Azul	200
8018335590	IRT 602	1,5 - 2,5	6,5	12	11	27	10	4,5	2,3	Blue / Azul	200
8018335600	IRT 802	1,5 - 2,5	8,4	12	11	27	10	4,5	2,3	Blue / Azul	200
8018335610	IRT 1002	1,5 - 2,5	10,5	13,6	13,9	30,7	10	4,5	2,3	Blue / Azul	100
8018335620	IRT 406	4,0 - 6,0	4,3	7,2	5,9	22	12,5	6,5	3,4	Yellow / Amarillo	75
8018335630	IRT 506	4,0 - 6,0	5,3	9,5	8,3	25,5	12,5	6,5	3,4	Yellow / Amarillo	75
8018335640	IRT 606	4,0 - 6,0	6,5	12	10,5	29	12,5	6,5	3,4	Yellow / Amarillo	75
8018335650	IRT 806	4,0 - 6,0	8,4	15	13,7	33,7	12,5	6,5	3,4	Yellow / Amarillo	75
8018335660	IRT 1006	4,0 - 6,0	10,5	15	13,7	33,7	12,5	6,5	3,4	Yellow / Amarillo	75
8018335670	IRT 1206	4,0 - 6,0	13	19,2	16	38,1	12,5	6,5	3,4	Yellow / Amarillo	75
8018335680	IRT 510	8,0 - 10,0	5,3	12	9,7	32,5	17	8	4,5	Red / Rojo	50
8018335690	IRT 610	8,0 - 10,0	6,7	12	9,7	32,5	17	8	4,5	Red / Rojo	50

Insulated Fork Terminals

Terminales aislados tipo horquilla

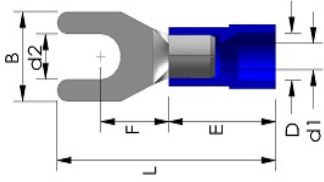

Material: Copper, Tin Plated
 Material: Cobre, Estañado
Isolation / Aislamiento PVC



Product Code Código de producto	Product Name Nombre de producto	Cross Sec. Sec. Trans. (mm ²)	Dimensions / Dimensiones (mm)							Color Color	Pack. Qty Qty (Pcs./Pzs)
			d2	B	F	L	E	D	d1		
8018335700	IFT 301	0,5 - 1,5	3,2	5,8	6,3	21	10	4,1	1,7	Red / Rojo	200
8018335720	IFT 401	0,5 - 1,5	4,3	6,4	6,3	20,6	10	4,1	1,7	Red / Rojo	200
8018335730	IFT 501	0,5 - 1,5	5,3	8	7	21	10	4,1	1,7	Red / Rojo	200
8018335740	IFT 601	0,5 - 1,5	6,5	12	11	27,2	10	4,1	1,7	Red / Rojo	200
8018335750	IFT 302	1,5 - 2,5	3,2	5,8	6,3	21	10	4,2	2,3	Blue / Azul	200
8018335760	IFT 402	1,5 - 2,5	4,3	6,4	6,3	21	10	4,2	2,3	Blue / Azul	200
8018335770	IFT 502	1,5 - 2,5	5,3	9,5	7,2	22	10	4,2	2,3	Blue / Azul	200
8018335780	IFT 602	1,5 - 2,5	6,5	12	11	27,2	10	4,2	2,3	Blue / Azul	200
8018335790	IFT 406	4,0 - 6,0	4,3	8,5	7,5	25,2	12,5	6,5	3,4	Yellow / Amarillo	75
8018335800	IFT 506	4,0 - 6,0	5,3	9,5	7,5	25,2	12,5	6,5	3,4	Yellow / Amarillo	75
8018335810	IFT 606	4,0 - 6,0	6,5	9,5	7,5	25,2	12,5	6,5	3,4	Yellow / Amarillo	75
8018335820	IFT 806	4,0 - 6,0	8,4	13,5	10,5	30	12,5	6,5	3,4	Yellow / Amarillo	75

Fast-on Female Terminals

Terminales Fast-on tipo hembra

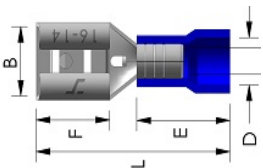

Material: Copper, Tin Plated
 Material: Cobre, Estañado
Isolation / Aislamiento PVC



Product Code Código de producto	Product Name Nombre de producto	Cross Sec. Sec. Trans. (mm ²)	Dimensions / Dimensiones (mm)					Color Color	Pack. Qty Qty (Pcs./Pzs)
			B	F	L	E	D		
8018336030	FFT 1288	0,5 - 1,5	3,20	6,5	19,0	10,5	3,8	Red / Rojo	200
8018336100	FFT 1488	0,5 - 1,5	5,00	6,4	19,4	10,5	3,8	Red / Rojo	200
8018336110	FFT 1638	0,5 - 1,5	6,60	7,5	20,8	10,5	3,8	Red / Rojo	200
8018336115	FFT 2288	1,5 - 2,5	5,00	6,4	19,4	10,5	4,7	Blue / Azul	150
8018336120	FFT 2488	1,5 - 2,5	6,60	7,5	20,8	10,5	4,7	Blue / Azul	150
8018336130	FFT 2638	1,5 - 2,5	6,60	7,5	23,3	13,0	6,2	Blue / Azul	150
8018336140	FFT 5638	4,0 - 6,0	6,6	7,2	23,3	13	5,6	Yellow / Amarillo	100

Insulated Fast-on Female Terminals

Terminales Fast-on tipo hembra aislados

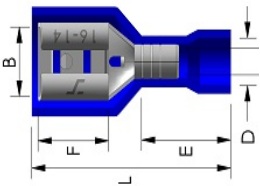

Material: Copper, Tin Plated
 Material: Cobre, Estañado
Isolation / Aislamiento PVC



Product Code Código de producto	Product Name Nombre de producto	Cross Sec. Sec. Trans. (mm ²)	Dimensions / Dimensiones (mm)					Color Color	Pack. Qty Qty (Pcs./Pzs)
			B	F	L	E	D		
8018336300	IFFT 1288	0,5 - 1,5	3,2	6,5	19,00	10,50	3,8	Red / Rojo	100
8018336310	IFFT 1488	0,5 - 1,5	5	6,4	20,50	10,50	3,8	Red / Rojo	100
8018336320	IFFT 1638	0,5 - 1,5	6,6	7,5	21,80	10,50	3,8	Red / Rojo	100
8018336325	IFFT 2288	1,5 - 2,5	5	6,4	20,20	10,50	4,7	Blue / Azul	100
8018336330	IFFT 2488	1,5 - 2,5	6,6	7,5	22,20	10,50	4,7	Blue / Azul	100
8018336340	IFFT 2638	1,5 - 2,5	6,6	7,5	24,20	12,50	6,2	Blue / Azul	100
8018336350	IFFT 5638	4,0 - 6,0	6,6	7,2	23,8	13	5,6	Yellow / Amarillo	75

Fast-on Male Terminals

Terminales Fast-on tipo macho

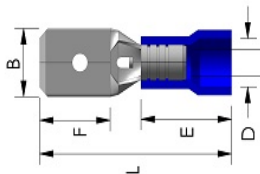

Material: Copper, Tin Plated
 Material: Cobre, Estañado
Isolation / Aislamiento PVC



Product Code Código de producto	Product Name Nombre de producto	Cross Sec. Sec. Trans. (mm ²)	Dimensions / Dimensiones (mm)					Color Color	Pack. Qty Qty (Pcs./Pzs)
			B	F	L	E	D		
8018336150	FMT 1288	0,5 - 1,5	2,80	6,5	19,2	10,5	3,8	Red / Rojo	200
8018336160	FMT 1488	0,5 - 1,5	4,80	6,7	19,8	10,5	3,8	Red / Rojo	200
8018336170	FMT 1638	0,5 - 1,5	6,35	7,7	21,8	10,5	3,8	Red / Rojo	200
8018336175	FMT 2288	1,5 - 2,5	4,80	6,7	19,8	10,5	4,7	Blue / Azul	200
8018336180	FMT 2488	1,5 - 2,5	6,35	7,7	21,8	10,5	4,7	Blue / Azul	200
8018336190	FMT 2638	1,5 - 2,5	6,35	7,7	24,8	13,0	6,2	Blue / Azul	200
8018336200	FMT 5638	4,0 - 6,0	6,3	7,7	24	13	5,6	Yellow / Amarillo	100

Piggy Back Terminals

Terminales de conexión en cascada

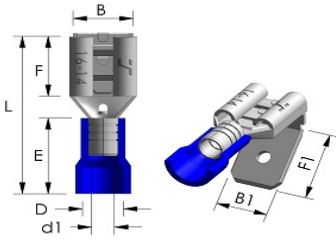

Material: Copper, Tin Plated
 Material: Cobre, Estañado
Isolation / Aislamiento PVC



Product Code Código de producto	Product Name Nombre de producto	Cross Sec. Sec. Trans. (mm ²)	Dimensions / Dimensiones (mm)								Color Color	Pack. Qty Qty (Pcs./Pzs)
			B	B1	F	F1	L	E	D	d1		
8018336460	PBT 1638	0,5 - 1,5	6,6	6,3	8	8,2	22	10	3,5	1,7	Red / Rojo	100
8018336470	PBT 2638	1,5 - 2,5	6,6	6,3	8	8,2	22	10	4,2	2,3	Blue / Azul	100
8018336480	PBT 5638	4,0 - 6,0	6,6	6,3	8	8,2	25	13	5,6	3,4	Yellow / Amarillo	75

Insulated Pin Terminals

Terminales aislados tipo pin

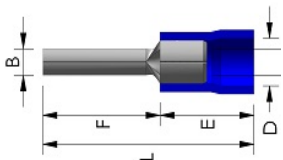

Material: Copper, Tin Plated
 Material: Cobre, Estañado
Isolation / Aislamiento PVC



Product Code Código de producto	Product Name Nombre de producto	Cross Sec. Sec. Trans. (mm ²)	Dimensions / Dimensiones (mm)					Color Color	Pack. Qty Qty (Pcs./Pzs)
			B	F	L	E	D		
8018335900	IPT 1/1,5	0,5 - 1,5	1,9	10	20	10	4,0	Red / Rojo	200
8018335910	IPT 1/2,5	1,5 - 2,5	1,9	12	22	10	4,5	Blue / Azul	200
8018335920	IPT 1/6	4,0 - 6,0	2,8	14	27	13	6,4	Yellow / Amarillo	100

Bullet Female Terminals

Terminales de casquillo tipo hembra

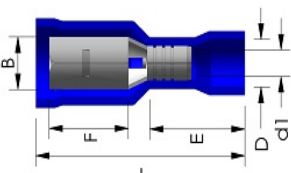

Material: Copper, Tin Plated
 Material: Cobre, Estañado
Isolation / Aislamiento PVC



Product Code Código de producto	Product Name Nombre de producto	Cross Sec. Sec. Trans. (mm ²)	Dimensions / Dimensiones (mm)						Color Color	Pack. Qty Qty (Pcs./Pzs)
			B	F	L	E	D	d1		
8018336600	BFT 1040	0,5 - 1,5	3,9	7,3	23,5	10	3,5	1,7	Red / Rojo	100
8018336610	BFT 2050	1,5 - 2,5	4,9	8,5	25	10	4,2	2,3	Blue / Azul	100
8018336620	BFT 5050	4,0 - 6,0	4,9	8,5	28	13	5,6	3,4	Yellow / Amarillo	50

Bullet Male Terminals

Terminales de casquillo tipo macho

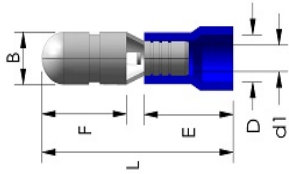

Material: Copper, Tin Plated
 Material: Cobre, Estañado
Isolation / Aislamiento PVC

Product Code Código de producto	Product Name Nombre de producto	Cross Sec. Sec. Trans. (mm ²)	Dimensions / Dimensiones (mm)						Color Color	Pack. Qty Qty (Pcs./Pzs)
			B	F	L	E	D	d1		
8018336700	BMT 1040	0,5 - 1,5	4	8,5	21	10	3,5	1,7	Red / Rojo	100
8018336710	BMT 2050	1,5 - 2,5	5	9	21,5	10	4,2	2,3	Blue / Azul	100
8018336720	BMT 5050	4,0 - 6,0	5	9	24,5	13	5,6	3,4	Yellow / Amarillo	100

Insulated Butt Terminals

Terminales de unión aislados

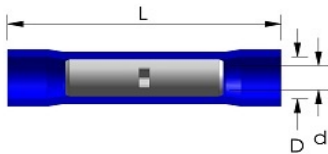

Material: Copper, Tin Plated
 Material: Cobre, Estañado
Isolation / Aislamiento PVC

Product Code Código de producto	Product Name Nombre de producto	Cross Sec. Sec. Trans. (mm ²)	Dimensions / Dimensiones (mm)			Color Color	Pack. Qty Qty (Pcs./Pzs)
			L	D	d		
8018336500	IBT 251	0,5 - 1,5	24,5	4,3	1,7	Red / Rojo	100
8018336510	IBT 252	1,5 - 2,5	24,5	4,8	2,3	Blue / Azul	100
8018336520	IBT 256	4,0 - 6,0	27	6,2	3,4	Yellow / Amarillo	75

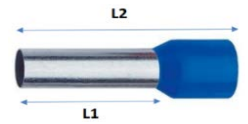

Insulated End Sleeves

Terminales tipo pin (Cerrados)

Material: Copper, Tin Plated
Material: Cobre, Estañado
Isolation / Aislamiento PA66



Product Code Código de producto	Product Name Nombre de producto	Dimensions / Dimensiones (mm)		Cross Sec. Sec. Trans. (mm ²)	AWG	Norm	Pack. Qty Qty (Pcs./Pzs)
		L1	L2				
8017335000	IES 0,50/8 Orange / Naranja	8	12	0,5	20	German / Alemana	1.000
8017335010	IES 0,75/8 White / Blanco	8	14	0,75	18	German / Alemana	1.000
8017335020	IES 1,0/8 Yellow / Amarillo	8	14	1	17	German / Alemana	1.000
8017335030	IES 1,5/8 Red / Rojo	8	14	1,5	16	German / Alemana	1.000
8017335040	IES 2,5/8 Blue / Azul	8	14	2,5	14	German / Alemana	500
8017335050	IES 4,0/10 Gray / Gris	10	17	4	12	German / Alemana	500
8017335060	IES 6,0/12 Black / Negro	12	20	6	10	German / Alemana	250
8017335070	IES 10,0/12 Ivory / Marfil	12	22	10	8	German / Alemana	100
8017335080	IES 16,0/12 Green / Verde	12	24	16	6	German / Alemana	100
8017335090	IES 25,0/16 Brown / Café	16	28	25	4	German / Alemana	50
8017335100	IES 35,0/16 Beige / Beige	16	30	35	2	German / Alemana	50
8017335110	IES 50,0/20 Oliva Green / Verde oliva	20	36	50	1	German / Alemana	25

Product Code Código de producto	Product Name Nombre de producto	Dimensions / Dimensiones (mm)		Cross Sec. Sec. Trans. (mm ²)	AWG	Norm	Pack. Qty Qty (Pcs./Pzs)
		L1	L2				
8017335005	IES 0,50/8 White / Blanco	8	12	0,5	20	French / Francesa	1.000
8017335015	IES 0,75/8 Blue / Azul	8	14	0,75	18	French / Francesa	1.000
8017335025	IES 1,0/8 Red / Rojo	8	14	1	17	French / Francesa	1.000
8017335035	IES 1,5/8 Black / Negro	8	14	1,5	16	French / Francesa	1.000
8017335045	IES 2,5/8 Gray / Gris	8	14	2,5	14	French / Francesa	500
8017335055	IES 4,0/10 Orange / Naranja	10	17	4	12	French / Francesa	500
8017335065	IES 6,0/12 Green / Verde	12	20	6	10	French / Francesa	250
8017335075	IES 10,0/12 Brown / Café	12	22	10	8	French / Francesa	100
8017335085	IES 16,0/12 Beige / Beige	12	24	16	6	French / Francesa	100
8017335095	IES 25,0/16 Black / Negro	16	28	25	4	French / Francesa	50
8017335105	IES 35,0/16 Red / Rojo	16	30	35	2	French / Francesa	50
8017335115	IES 50,0/20 Blue / Azul	20	36	50	1	French / Francesa	25



Twin Cord End Sleeves

Terminal tipo pin para cable bipolar

Material: Copper, Tin Plated
Material: Cobre, Estañado
Isolation / Aislamiento PA66

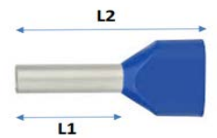

Product Code Código de producto	Product Name Nombre de producto	Dimensions / Dimensiones (mm)		Cross Sec. Sec. Trans. (mm ²)	Norm	Pack. Qty Qty (Pcs./Pzs)
		L1	L2			
8017335400	IES 2x0,50/8 Orange / Naranja	8	14	2 x 0,5	German / Alemana	1.000
8017335410	IES 2x0,75/8 White / Blanco	8	14	2 x 0,75	German / Alemana	500
8017335420	IES 2x1,0/8 Yellow / Amarillo	8	14	2 x 1,0	German / Alemana	500
8017335430	IES 2x1,5/8 Red / Rojo	8	14	2 x 1,5	German / Alemana	500
8017335440	IES 2x2,5/10 Blue / Azul	10	14	2 x 2,5	German / Alemana	250
8017335450	IES 2x4,0/12 Gray / Gris	12	17	2 x 4,0	German / Alemana	200
8017335460	IES 2x6,0/14 Black / Negro	14	20	2 x 6,0	German / Alemana	100
8017335470	IES 2x10,0/14 Ivory / Marfil	14	27	2 x 10	German / Alemana	50
8017335480	IES 2x16,0/14 Green / Verde	14	31	2 x 16	German / Alemana	50

Product Code Código de producto	Product Name Nombre de producto	Dimensions / Dimensiones (mm)		Cross Sec. Sec. Trans. (mm ²)	Norm	Pack. Qty Qty (Pcs./Pzs)
		L1	L2			
8017335405	IES 2x0,50/8 White / Blanco	8	14	2 x 0,5	French / Francesa	1.000
8017335415	IES 2x0,75/8 Blue / Azul	8	14	2 x 0,75	French / Francesa	500
8017335425	IES 2x1,0/8 Red / Rojo	8	14	2 x 1,0	French / Francesa	500
8017335435	IES 2x1,5/8 Black / Negro	8	14	2 x 1,5	French / Francesa	500
8017335445	IES 2x2,5/10 Gray / Gris	10	14	2 x 2,5	French / Francesa	250
8017335455	IES 2x4,0/12 Orange / Naranja	12	17	2 x 4,0	French / Francesa	200
8017335465	IES 2x6,0/14 Green / Verde	14	20	2 x 6,0	French / Francesa	100
8017335475	IES 2x10,0/14 Brown / Café	14	27	2 x 10	French / Francesa	50
8017335485	IES 2x16,0/14 Beige / Beige	14	31	2 x 16	French / Francesa	50



Non-insulated End Sleeves

Terminales tipo pin no aislados

Material: Copper, Tin Plated
Material: Cobre, Estañado

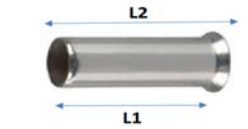

Product Code Código de producto	Product Name Nombre de producto	Dimensions / Dimensiones (mm)		Cross Sec. Sec. Trans. (mm ²)	AWG	Pack. Qty Qty (Pcs./Pzs)
		L1	L2			
8017335220	ES 0,50/10	8	10	0,50	20	2.000
8017335230	ES 0,75/10	8	10	0,75	18	2.000
8017335240	ES 1,0/10	8	10	1,00	17	2.000
8017335250	ES 1,5/10	8	10	1,50	15	2.000
8017335260	ES 2,5/12	8	12	2,50	13	2.000
8017335270	ES 4,0/12	10	12	4,00	11	1.000
8017335280	ES 6,0/12	10	12	6,00	9	500
8017335290	ES 10,0/15	12	15	10,00	7	200
8017335300	ES 16,0/15	12	15	16,00	5	200
8017335310	ES 25,0/16	16	16	25,00	4	100
8017335320	ES 35,0/16	16	16	35,00	2	100
8017335330	ES 50,0/20	20	20	50,00	1	50



LED Indicators - Ø22 mm

Indicadores LED - Ø22 mm

Product Code Código de producto	Product Name Nombre de producto		Nominal Voltage (V) Voltaje Nominal (V)	Color Color	Pack. Qty Qty (Pcs./Pzs)
8026078912	SIL22-220 Red Signal Lamp with LED		220V AC	●	25
8026078915	SIL22-220 Green Signal Lamp with LED		220V AC	●	25
8026078914	SIL22-220 Yellow Signal Lamp with LED		220V AC	●	25
8026078916	SIL22-220 Blue Signal Lamp with LED		220V AC	●	25
8026078919	SIL22-220 White Signal Lamp with LED		220V AC	○	25
8026078922	SIL22-220DC Red Signal Lamp with LED		220V DC	●	25
8026078925	SIL22-220DC Green Signal Lamp with LED		220V DC	●	25
8026078924	SIL22-220DC Yellow Signal Lamp with LED		220V DC	●	25
8026078926	SIL22-220DC Blue Signal Lamp with LED		220V DC	●	25
8026078929	SIL22-220DC White Signal Lamp with LED		220V DC	○	25
8026078932	SIL22-110 Red Signal Lamp with LED		110V AC/DC	●	25
8026078935	SIL22-110 Green Signal Lamp with LED		110V AC/DC	●	25
8026078934	SIL22-110 Yellow Signal Lamp with LED		110V AC/DC	●	25
8026078936	SIL22-110 Blue Signal Lamp with LED		110V AC/DC	●	25
8026078939	SIL22-110 White Signal Lamp with LED		110V AC/DC	○	25
8026078942	SIL22-24 Red Signal Lamp with LED		24V AC/DC	●	25
8026078945	SIL22-24 Green Signal Lamp with LED		24V AC/DC	●	25
8026078944	SIL22-24 Yellow Signal Lamp with LED		24V AC/DC	●	25
8026078946	SIL22-24 Blue Signal Lamp with LED		24V AC/DC	●	25
8026078949	SIL22-24 White Signal Lamp with LED		24V AC/DC	○	25



SIL22-24 Red/Rojo



SIL22-220 Green/Verde



SIL22-220 Yellow/Amarillo



SIL22-220 Blue/ Azul



SIL22-24 White/Blanco

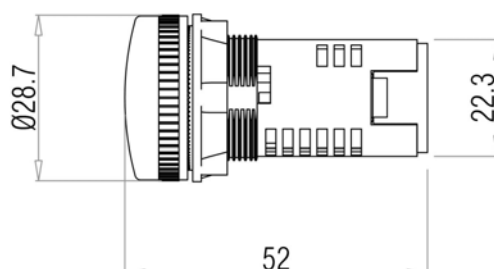

Push Buttons Spring Return - Ø22 mm

Botón de retorno elástico - Ø22 mm



Product Code Código de producto	Product Name Nombre de producto	Contact Contacto	Color Color	Pack. Qty Qty (Pcs./Pzs)
8025078002	PSR-1C Red Spring Return 1 NC	1 NC		15
8025078075	PSR-1O Green Spring Return 1 NO	1 NA		15
8025078104	PSR-1O Yellow Spring Return 1 NO	1 NA		15
8025078106	PSR-1O Blue Spring Return 1 NO	1 NA		15
8025078109	PSR-1O White Spring Return 1 NO	1 NA		15
8025078100	PSR-1O Black Spring Return 1 NO	1 NA		15

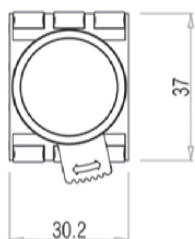
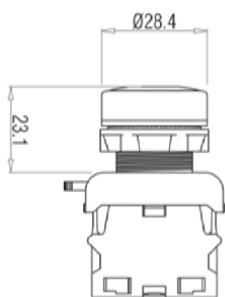

PSR-10 Yellow/Amarillo



PSR-1C Red/Rojo



PSR-1C Green/Verde

Push Buttons Spring Return Chromated - Ø22 mm

Botón cromado de retorno elástico - Ø22 mm

Product Code Código de producto	Product Name Nombre de producto	Contact Contacto	Color Color	Pack. Qty Qty (Pcs./Pzs)
8025078062	PSRC-1C Red Spring Return 1 NC Chromated	1 NK		15
8025078105	PSRC-1O Green Spring Return 1 NO Chromated	1 NA		15
8025078114	PSRC-1O Yellow Spring Return 1 NO Chromated	1 NA		15
8025078116	PSRC-1O Blue Spring Return 1 NO Chromated	1 NA		15
8025078119	PSRC-1O White Spring Return 1 NO Chromated	1 NA		15
8025078110	PSRC-1O Black Spring Return 1 NO Chromated	1 NA		15



Product Code Código de producto	Product Name Nombre de producto	Nominal Voltage (V) Voltaje Nominal (V)	Color Color	Pack. Qty Qty (Pcs./Pzs)
8025078022	PSRL-1C 220 Red Spring Return 1 NC with LED	220 V AC/DC	●	15
8025078085	PSRL-1O 220 Green Spring Return 1 NO with LED	220 V AC/DC	●	15
8025078224	PSRL-1O 220 Yellow Spring Return 1 NO with LED	220 V AC/DC	●	15
8025078226	PSRL-1O 220 Blue Spring Return 1 NO with LED	220 V AC/DC	●	15
8025078229	PSRL-1O 220 White Spring Return 1 NO with LED	220 V AC/DC	○	15
8025078032	PSRL-1C 110 Red Spring Return 1 NC with LED	110 V AC/DC	●	15
8025078095	PSRL-1O 110 Green Spring Return 1 NO with LED	110 V AC/DC	●	15
8025078234	PSRL-1O 110 Yellow Spring Return 1 NO with LED	110 V AC/DC	●	15
8025078236	PSRL-1O 110 Blue Spring Return 1 NO with LED	110 V AC/DC	●	15
8025078239	PSRL-1O 110 White Spring Return 1 NO with LED	110 V AC/DC	○	15
8025078042	PSRL-1C 48 Red Spring Return 1 NC with LED	48 V AC/DC	●	15
8025078205	PSRL-1O 48 Green Spring Return 1 NO with LED	48 V AC/DC	●	15
8025078204	PSRL-1O 48 Yellow Spring Return 1 NO with LED	48 V AC/DC	●	15
8025078206	PSRL-1O 48 Blue Spring Return 1 NO with LED	48 V AC/DC	●	15
8025078209	PSRL-1O 48 White Spring Return 1 NO with LED	48 V AC/DC	○	15
8025078052	PSRL-1C 24 Red Spring Return 1 NC with LED	24 V AC/DC	●	15
8025078215	PSRL-1O 24 Green Spring Return 1 NO with LED	24 V AC/DC	●	15
8025078214	PSRL-1O 24 Yellow Spring Return 1 NO with LED	24 V AC/DC	●	15
8025078216	PSRL-1O 24 Blue Spring Return 1 NO with LED	24 V AC/DC	●	15
8025078219	PSRL-1O 24 White Spring Return 1 NO with LED	24 V AC/DC	○	15

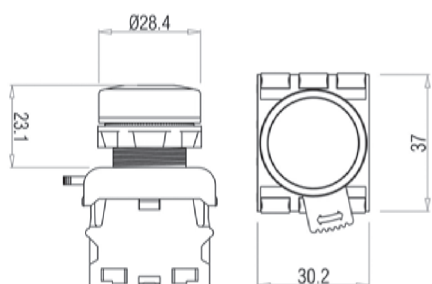

PSRL-1C Red/Rojo



PSRL-1O Green/Verde



PSRL-1O Blue/Azul



Product Code Código de producto	Product Name Nombre de producto	Nominal Voltage (V) Voltaje Nominal (V)	Color Color	Pack. Qty Qty (Pcs./Pzs)
8025078022	PSRL-1C 220 Red Spring Return 1 NC with LED	220 V AC/DC		15
8025078085	PSRL-1O 220 Green Spring Return 1 NO with LED	220 V AC/DC		15
8025078224	PSRL-1O 220 Yellow Spring Return 1 NO with LED	220 V AC/DC		15
8025078226	PSRL-1O 220 Blue Spring Return 1 NO with LED	220 V AC/DC		15
8025078229	PSRL-1O 220 White Spring Return 1 NO with LED	220 V AC/DC		15
8025078032	PSRL-1C 110 Red Spring Return 1 NC with LED	110 V AC/DC		15
8025078095	PSRL-1O 110 Green Spring Return 1 NO with LED	110 V AC/DC		15
8025078234	PSRL-1O 110 Yellow Spring Return 1 NO with LED	110 V AC/DC		15
8025078236	PSRL-1O 110 Blue Spring Return 1 NO with LED	110 V AC/DC		15
8025078239	PSRL-1O 110 White Spring Return 1 NO with LED	110 V AC/DC		15
8025078042	PSRL-1C 48 Red Spring Return 1 NC with LED	48 V AC/DC		15
8025078205	PSRL-1O 48 Green Spring Return 1 NO with LED	48 V AC/DC		15
8025078204	PSRL-1O 48 Yellow Spring Return 1 NO with LED	48 V AC/DC		15
8025078206	PSRL-1O 48 Blue Spring Return 1 NO with LED	48 V AC/DC		15
8025078209	PSRL-1O 48 White Spring Return 1 NO with LED	48 V AC/DC		15
8025078052	PSRL-1C 24 Red Spring Return 1 NC with LED	24 V AC/DC		15
8025078215	PSRL-1O 24 Green Spring Return 1 NO with LED	24 V AC/DC		15
8025078214	PSRL-1O 24 Yellow Spring Return 1 NO with LED	24 V AC/DC		15
8025078216	PSRL-1O 24 Blue Spring Return 1 NO with LED	24 V AC/DC		15
8025078219	PSRL-1O 24 White Spring Return 1 NO with LED	24 V AC/DC		15

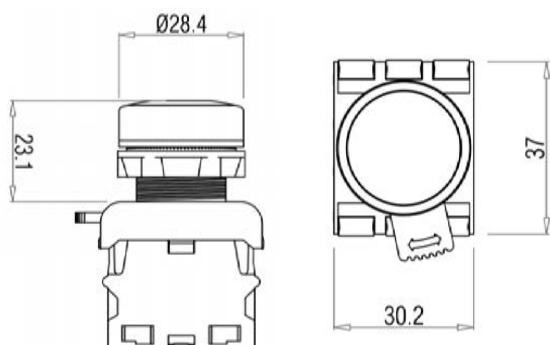











PSRLC-1C Red/Rojo



PSRLC-1O Green/Verde



Product Code Código de producto	Product Name Nombre de producto	Contact Contacto	Color Color	Pack. Qty Qty (Pcs./Pzs)
8025078302	DSR-1C10 Double Spring Return 1NO+1NC	DSR-1C10 Doble - Retorno elástico - 1NO+1NC	1 NO + 1 NC	 10
8025078700	DSRC-1C10 Double Spring Return 1NO+1NC Chromated	DSRC-1C10 Doble - Retorno elástico - 1NO+1NC - Cromado	1 NO + 1 NC	 10
8025078312	DSRL-1C10 220 Double Spring Return 1NO+1NC with LED	DSRL-1C10 220 Doble - Retorno elástico - 1NO+1NC - con LED	1 NO + 1 NC	 10
8025078362	DSRL-1C10 110 Double Spring Return 1NO+1NC with LED	DSRL-1C10 110 Doble - Retorno elástico - 1NO+1NC - con LED	1 NO + 1 NC	 10
8025078372	DSRL-1C10 24 Double Spring Return 1NO+1NC with LED	DSRL-1C10 24 Doble - Retorno elástico - 1NO+1NC - con LED	1 NO + 1 NC	 10
8025079002	DSR-20 Double Spring Return 2NO	DSR-20 Doble - Retorno elástico - 2NO	2 NO	 10
8025079702	DSR-20 Double Spring Return 2NO Chromated	DSR-20 Doble - Retorno elástico - 2NO - Cromado	2 NO	 10
8025079012	DSRL-20 220 Double Spring Return 2NO with LED	DSRL-20 220 Doble - Retorno elástico - 2NO - con LED	2 NO	 10
8025079062	DSRL-20 110 Double Spring Return 2NO with LED	DSRL-20 110 Doble - Retorno elástico - 2NO - con LED	2 NO	 10
8025079072	DSRL-20 24 Double Spring Return 2NO with LED	DSRL-20 24 Doble - Retorno elástico - 2NO - con LED	2 NO	 10

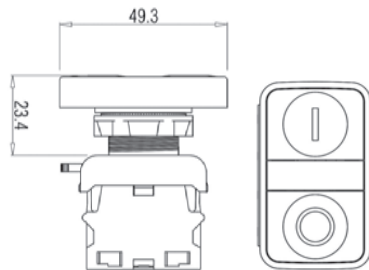

DSR-1C10

Selector Switches Maintained - Ø22 mm

Switches selectores de estado sostenido - Ø22 mm



Product Code Código de producto	Product Name Nombre de producto		Contact Contacto	Color Color	Position Posición	Pack. Qty Qty (Pcs./Pzs)
8025078500	SSP-10, 2 pos. 1NO 90°		1 NO	●		12
8025078501	SSP-1C10, 3 pos. 1NO +1NC		1 NO+1NC	●		12
8025078510	SSP-20, 3 pos. 2NO 60°		2 NO	●		12
8025078710	SSPC-10, 2 pos. 1NO 90° Chromated		1 NO	●		12
8025078720	SSPC-20, 3 pos. 2NO 60° Chromated		2 NO	●		12

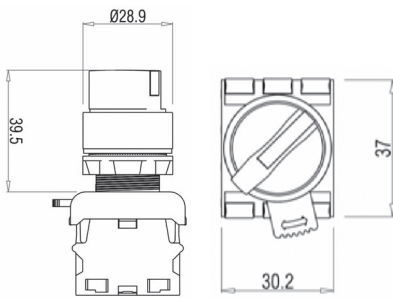

SSPC-20



SSP-20

Emergency Stop - Ø 22 mm

Parada de emergencia - Ø 22 mm



Product Code Código de producto	Product Name Nombre de producto		Contact Contacto	Color Color	Pack. Qty Qty (Pcs./Pzs)
8025078012	EPB-1C Emergency Stop 1 NC		1NC	●	10

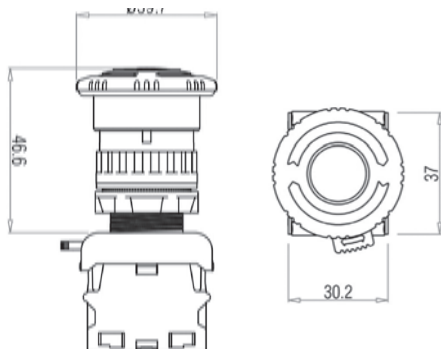

EPB-1C

Selector Switches Maintained with LED - Ø22 mm

Switches selectores de estado sostenido con LED - Ø22 mm



Product Code Código de producto	Product Name Nombre de producto	Contact Contacto	Color Color	Position Posición	Pack. Qty Qty (Pcs./Pzs)
8025078602	SSP-10 220 L, 2 position 1NO 90° with LED	220 V AC/DC	Red		12
8025078605	SSP-10 220 L, 2 position 1NO 90° with LED	220 V AC/DC	Green		12
8025078604	SSP-10 220 L, 2 position 1NO 90° with LED	220 V AC/DC	Yellow		12
8025078622	SSP-20 220 L, 3 position 1NO 60° with LED	220 V AC/DC	Red		12
8025078615	SSP-20 220 L, 3 position 1NO 60° with LED	220 V AC/DC	Green		12
8025078614	SSP-20 220 L, 3 position 1NO 60° with LED	220 V AC/DC	Yellow		12

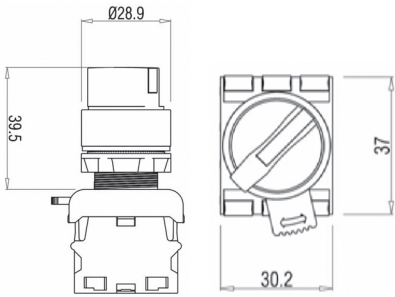

SSP-10 220 L Green/Verde



SSP-10 220 L Red/Rojo

Selector Switch Momentary with LED - Ø22 mm

Switches selectores de estado temporal con LED - Ø22 mm



Product Code Código de producto	Product Name Nombre de producto	Contact Contacto	Color Color	Position Posición	Pack. Qty Qty (Pcs./Pzs)
8025078402	SSM-10 220 L, 1NO 90° with LED	220 V AC/DC	Red		12
8025078405	SSM-10 220 L, 2 position 1NO 90° with LED	220 V AC/DC	Green		12
8025078404	SSM-10 220 L, 2 position 1NO 90° with LED	220 V AC/DC	Yellow		12
8025078422	SSM-20 220 L, 3 position 2NC 60° with LED	220 V AC/DC	Red		12
8025078415	SSM-20 220 L, 3 position 2NO 60° with LED	220 V AC/DC	Green		12
8025078424	SSM-20 220 L, 3 position 2NO 60° with LED	220 V AC/DC	Yellow		12

LED li Kalıcı ve Yaylı Tip Seçici Butonların 110V AC/DC ve 24V AC/DC Nominal Gerilimleri için lütfen satış temsilcinizle irtibata geçiniz.



Product Code Código de producto	Product Name Nombre de producto		Contact Contacto	Color Color	Position Posición	Pack. Qty Qty (Pcs./Pzs)
8025078320	SSM-10, 2 position 1NO 90°	SSM-10, 2 posiciones 1NO 90°	1 NO	●		12
8025078330	SSM-20, 3 position 2NO 60°	SSM-20, 3 posiciones 2NO 60°	2 NO	●		12
8025078340	SSMC-10, 2 position 1NO 90° Chromated	SSMC-10, 2 posiciones 1NO 90° Cromado	1 NO	●		12
8025078350	SSMC-20, 3 position 2NO 60° Chromated	SSMC-20, 3 position 2NO 60° Cromado	2 NO	●		12

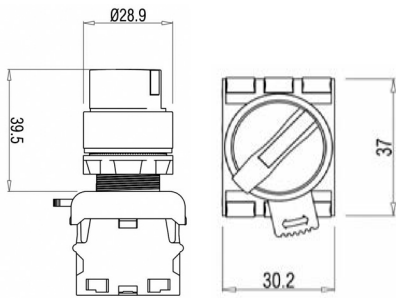

SMM-10



Product Code Código de producto	Product Name Nombre de producto	Contact Contacto	Pack. Qty Qty (Pcs./Pzs)
8025078800	CNT-O NO Contact	CNT-O Contacto NO	50
8025078810	CNT-C NC Contact	CNT-C Contacto NC	50
8025078820	CNT-S Signal Contact	CNT-S Contacto Signal	50

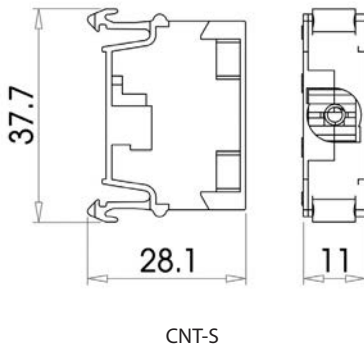
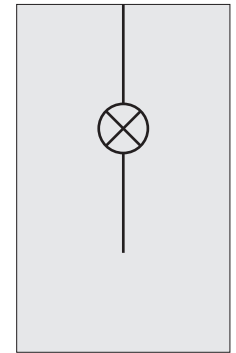
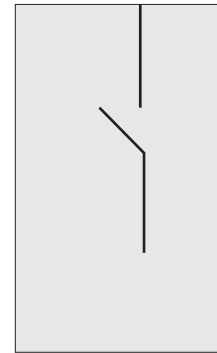
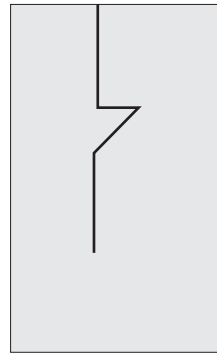
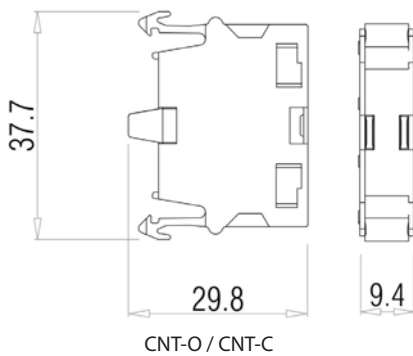

Technical information / Información técnica

Standard / Estándar	IEC 60947-5-1
Operating Temperature min/max (°C) / Temp. operación mín/máx (°C)	-5 / +40
Pollution Severity / Grado de contaminación	3
Rated Insulation Voltage (V) / Voltaje de aislamiento nominal (V)	400
Rated Impulse Withstand V. (kV) / Voltaje nominal de resistencia al impulso (kV)	4
Conventional Thermal Current / Corriente térmica convencional (A)	10
Utilization Category / Categoría de utilización	AC 15

Rated Operational Voltage / Volt. nominal de operación (V)	Rated Operational Current / Corr. nominal de operación (A)
380	1,9
240	3
120	6

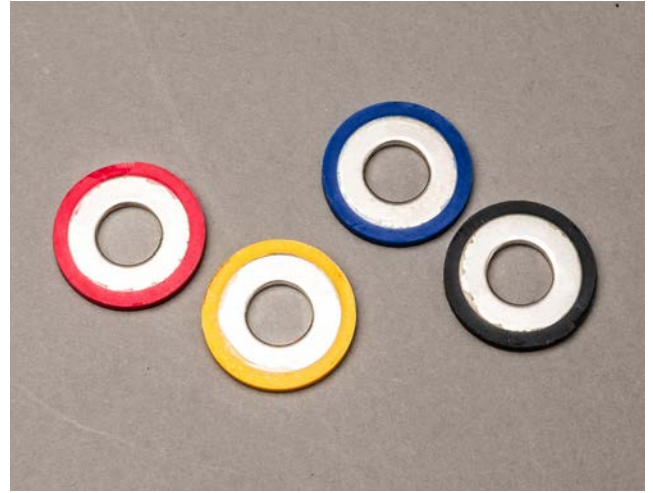

- **47.9 kV isolation**
will ensure a higher isolation compared with heat shrinkable tubes in addition to its over heat indication function
- **Easy installation**
you can perform your maintenance and replacements without any cable cut
- **Predictive maintenance and protection**
you can detect the over heating problems between two different temperature controls and protect your system
- **Heat sensitive color change**
will eliminate your heat gun requirement, and you can detect the over heat by naked eye
- **Different color options**
will assist your phase identification



- **Aislamiento de 47.9 kV**

brinda un mayor aislamiento en comparación con los tubos termoencogibles, además de su función para indicar temperaturas superiores al límite establecido

- **Fácil instalación**

podrá llevar a cabo sus mantenimientos y reemplazos sin corte de cables

- **Mantenimiento preventivo y protección**

puede detectar excesos de temperatura entre dos diferentes controles de temperatura y de esta manera, proteger su sistema

- **Cambio de color dependiente de temperatura**

Eliminando la necesidad de herramientas externas, permite la detección a simple vista de problemas de temperatura

- **Diferentes opciones de color**

facilitando la identificación de las fases

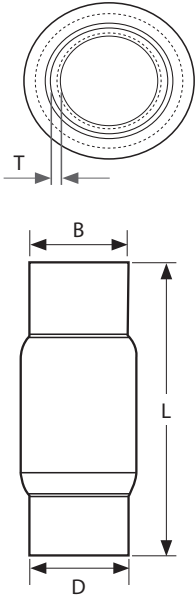

Product Code Código de producto	Product Name Nombre de producto	Dimensions / Dimensiones				Cross Sec. Sec. Trans. (mm ²)	AWG	Pack. Qty Qty (Pcs./Pzs)
		D	B	L	T			
8028320020	TIK 10 Black / Negro	7,10	6,50	21,00	1,10	10	8	12
8028320030	TIK 16 Black / Negro	9,00	7,70	24,00	1,14	16	6	12
8028320040	TIK 25 Black / Negro	10,25	10,20	31,21	1,25	25	4	12
8028320050	TIK 35 Black / Negro	10,71	10,70	35,00	1,30	35	2-3	12
8028320060	TIK 50 Black / Negro	11,60	12,80	37,70	1,50	50	1	12
8028320070	TIK 70 Black / Negro	14,60	14,00	39,00	1,60	70	1/0	12
8028320080	TIK 95 Black / Negro	16,60	16,10	43,50	1,64	95	2/0	6
8028320090	TIK 120 Black / Negro	21,60	19,70	48,50	1,75	120	3/0	6
8028320100	TIK 150 Black / Negro	23,40	20,60	56,65	1,85	150	4/0	6
8028320110	TIK 185 Black / Negro	25,93	24,40	64,00	1,90	185	250-300 kcmil	3
8028320120	TIK 240 Black / Negro	30,13	26,80	70,00	2,00	240	350-400 kcmil	3
8028320130	TIK 300 Black / Negro	35,19	30,70	76,00	2,16	300	450-500 kcmil	3
8028320300	TIK 400 Black / Negro	35,00	35,00	101,00	2,10	400	550 - 650 kcmil	1
8028320310	TIK 500 Black / Negro	39,50	38,12	107,00	2,40	500	700 - 800 kcmil	1

Reference Point Feedback
Retroalimentación de punto de referencia

Color codes / Código de colores



TIK 70
8028320070



TIK 70
802832002

Black / Negro	0
Red / Rojo	2
Yellow / Amarillo	4
Green / Verde	5
Blue / Azul	6







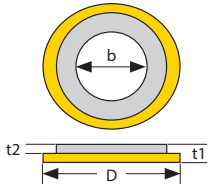

Thermal Indicator Washers

Arandelas indicadoras de temperatura



Product Code Código de producto	Product Name Nombre de producto	Dimensions / Dimensiones				Pack. Qty Qty (Pcs./Pzs)
		D	b	t1	t2	
8028320400	TIW M8 Black / Negro	17	8,2	3	1,5	5
8028320410	TIW M10 Black / Negro	23	10,2	3	1,5	5
8028320420	TIW M12 Black / Negro	26	12,2	3	1,5	5
8028320430	TIW M14 Black / Negro	32	14,2	3	1,5	5
8028320440	TIW M16 Black / Negro	32	16,2	3	1,5	5

Color codes / Código de colores		
	Black / Negro0
	Red / Rojo2
	Yellow / Amarillo4
	Green / Verde5
	Blue / Azul6

 TIW M10 8028320410
 TIW M10 8028320414





HEADQUARTER / SEDE

**Tbloc Elektrik Elektronik
Sanayi ve Ticaret A.Ş.**

29 Ekim Mahallesi
10001 Sokak No: 50/4
35663 Menemen İzmir Turkey

Tel: +90 232 833 26 96

Fax: +90 232 833 26 97

info@tbloc.com.tr

www.tbloc.com.tr

